

dimensions	G¼" SW19x37mm	
	G¼" SW19x49mm	
	G½" SW27x46mm	
	G½" SW27x58mm	
	G½" SW27x63mm	
	G¾" SW27x75mm	
	55 x 75 x 110mm (amplifier)	
flow	water	1 ... 150cm/s
	oil	3 ... 300cm/s

- ✓ sensor: reliability thanks to fully electronic operation
- ✓ amplifier: 7 LED displays for alignment and function control
- ✓ DIN plastic housing 55 wide
- ✓ cable connection to the amplifier up to 100m
- ✓ mounting on DIN-rail



11

**flow and temperature control
one-piece V4A stainless steel housing**



description

The flow sensor functions according to the calorimetric principle. The measuring probe is heated by a few degrees (Celsius) above the temperature of the medium. Heat is dissipated by the medium flowing past. The difference in temperature between the medium and the sensor is a measure for the flow condition which occurs.

A corresponding switching signal can be assigned via the internal relay for a specific flow condition using the potentiometer of the integrated amplifier electronics.

With the adjustable turn-off delay, the relay remains in its initial state if there is a short-term dip in the flow. It is possible to identify when a specific temperature is exceeded or not using a second built-in relay.

Assembly can take place regardless of the direction of flow. It is essential to ensure that the sensor head is fully surrounded by the medium to be monitored, not only when the medium is at rest but also when it is flowing. In the case of small cross sec-

tions, care should be taken that the tip of the probe does not reduce the cross section of the pipe by a substantial amount. Instable flow forms cause malfunctions. In order to avoid this, no installation parts influencing the cross section or the direction of flow should be fitted directly in front of and/or behind the sensor. The rough guideline value for this inlet/outlet path is approx. 8 times the diameter of the pipeline.

application examples

- ▶ dry-run protection for pumps
- ▶ continuous monitoring of the presence of a flow of fluids
- ▶ additional temperature monitoring of the different media
- ▶ monitoring of filters and sieves
- ▶ assuring the circulation of cooling water to automated welding systems
- ▶ recognizing the movement of granulates

TECHNICAL DATA	
operating voltage	230V AC or 24V DC
power consumption	< 8VA
output	2x relay, change-over contact 250V AC, 4A / 60V DC, 4A
contact life	for 0.5A approx. 2.5×10^7 operating cycles
setting (flow)	water 1 ... 150cm/s oil 3 ... 300cm/s
temperature setting	-20 ... +100°C
readiness delay	2 ... 15s
response time	1 ... 13s
turn-off delay	0 ... 25s
degree of protection (EN 60529)	sensor: IP68 (cable), IP67 (connector) amplifier: IP40 (housing), IP20 (terminals)
operating temperature	sensor: -20 ... +80°C amplifier: -20 ... +60°C
temperature gradient	250°C/min
line length	between sensor and amplifier, max. 100m
housing material	sensor: V4A, (pressure resistant up to 100 bar) amplifier: plastic
mounting (amplifier)	on DIN-rail according to DIN EN 50022

pin configuration of the amplifier

terminal 1	n.c.	
2	n.c.	
3	n.c.	
4	n.c.	
5	sensor black	
6	sensor white	
7	sensor brown	
8	sensor blue	
9	relay make contact	flow
10	relay break contact	flow
11	relay center contact	flow
12	relay make contact	temperature
13	relay break contact	temperature
14	relay center contact	temperature
15	230V AC	(0V DC)
16	230V AC	(24V DC)

connection

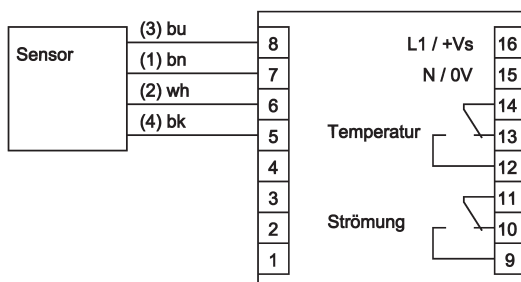

setting instructions

2 potentiometers are available for the calibration: as a rule the "Fein" potentiometer should be set in a central position for fine adjustment. The principal calibration is done with the "Grob" potentiometer, as specified in the operating instructions.

calibration for stationary medium

Install sensor and set potentiometer in such a way that the red LED lights up.
In case of a flow at least one green LED must light up.

calibration for flowing medium

Install sensor and adjust potentiometer in such a way that two green LEDs light up.
When the medium is stationary, the red LED lights up.

falling below the set flow

Install sensor, set the flow and then adjust the potentiometer so that the first green LED just lights up.
Any reduction of the flow speed causes the green LED to go out first, subsequently the yellow LED extinguishes and the relay is de-energized. Now the red LED lights up.

exceeding the set flow

Install sensor, set the flow and then adjust the potentiometer so that the red LED just lights up.
Any increase of the flow speed causes the red LED to extinguish, the yellow LED lights up and the relay is energized.

fig. 1 amplifier

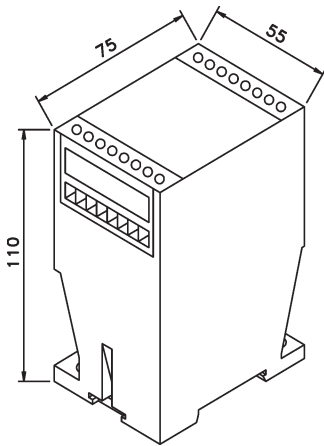

fig. 2 G $\frac{1}{4}$ short

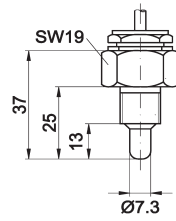

fig. 3 G $\frac{1}{4}$ short, connector

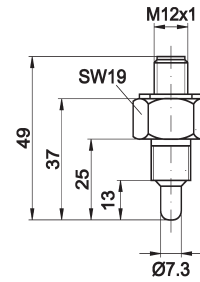

fig. 4 G $\frac{1}{2}$

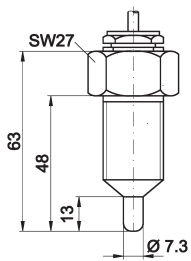

fig. 5 G $\frac{1}{2}$, connector

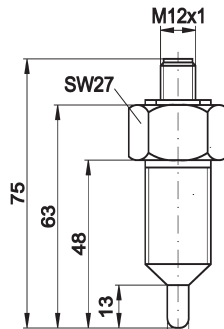

fig. 6 G $\frac{1}{2}$ short

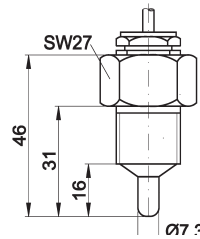

fig. 7 G $\frac{1}{2}$ short, connector

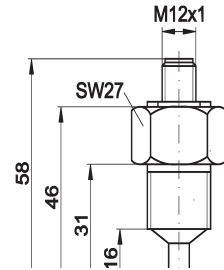
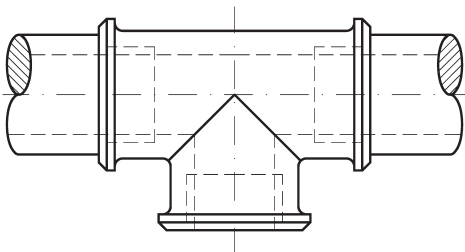

fig. 8 T-piece



T-piece: The middle number of the design (see article list) indicates the thread of the sensor.

article-no.	dimensions	description	comment	screw-in depth	output	voltage	current	connection	figure
SV550800	55x75x110	amplifier	time,temp.		relay	24V DC	2A	terminals	1
SV554800	55x75x110	amplifier	time,temp.		relay	230V AC	2A	terminals	1
SS896004	G $\frac{1}{4}$	probe	short	25	amplifier connection			cable	2
SS896024	G $\frac{1}{4}$	probe	short	25	amplifier connection			M12-connector, 4-pin	3
SS906000	G $\frac{1}{2}$	probe		48	amplifier connection			cable	4
SS906020	G $\frac{1}{2}$	probe		48	amplifier connection			M12-connector, 4-pin	5
SS906004	G $\frac{1}{2}$	probe	short	31	amplifier connection			cable	6
SS906024	G $\frac{1}{2}$	probe	short	31	amplifier connection			M12-connector, 4-pin	7
SS906080	G $\frac{1}{2}$	probe	120°C	48	amplifier connection			teflon cable	4
SS906084	G $\frac{1}{2}$	probe	short,120°C	31	amplifier connection			teflon cable	6
AS000001	$\frac{1}{4}$ - $\frac{1}{4}$ - $\frac{1}{4}$	accessories	T-piece		red brass G $\frac{1}{4}$ short				8
AS000002	$\frac{1}{2}$ - $\frac{1}{2}$ - $\frac{1}{2}$	accessories	T-piece		red brass G $\frac{1}{2}$ short				8
AS000004	$\frac{3}{4}$ - $\frac{1}{2}$ - $\frac{3}{4}$	accessories	T-piece		red brass G $\frac{1}{2}$ short				8
AS000005	1- $\frac{1}{2}$ -1	accessories	T-piece		red brass G $\frac{1}{2}$				8
AV000016	125x125x126	accessories	housing, IP67		For amplifier SV55				without

notes (LED indicators at the amplifier)

flow LED

red

Flow interrupted or falls below the set flow value.
The relay "flow" is de-energized.

yellow

The set flow value is achieved.
The relay "flow" is energized.

green

The set flow value is exceeded.
The flow reserve is sufficient.
The relay "flow" is energized.

turn-off delay

yellow and red

The LEDs light up when the flow value falls below the set value.
The "flow" relay remains energized until the set time value of the turn-off delay is up.

temperature LED

red

The set temperature is exceeded.
The relay "temperature" is energized.

This data sheet only contains the available standard variants. For other output / connection variants, we kindly ask that you contact us.

We are happy to supply the right cable socket for the plug equipment. You will find a list in the "accessories" section of the catalog under **ipf-SENSORFLEX**® "cable sockets" or in the search window on our homepage www.ipf-electronic.com (using the search term "VK").

Warning: Never use these devices in applications where the safety of a person depends on their functionality.

You also find this data sheet, as well as contact details under www.ipf-electronic.com