

dimensions	15.4 x 50 x 50mm	
through-beam sensors	operating range	3.0m
retro-reflective sensors	operating range	up to 7.0m
dif. reflection sensors	sensing range	20 to 600mm

- ✓ dif. reflection sensors with background suppression
- ✓ retro-reflective sensors with polarizing filter
- ✓ simple adjustment
- ✓ high sensing ranges
- ✓ light-on and dark-on mode
- ✓ fast response time
- ✓ LED-display of the switch signal
- ✓ degree of protection IP67
- ✓ connection with M12-connector or cable

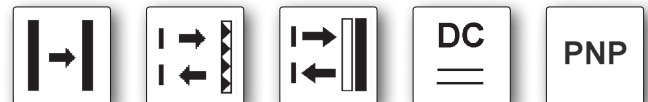

visible red light
robust metal housing



description

Optoelectronic sensors are indispensable components in all automated production processes. They are used in all applications where parts are to be detected, counted, measured or positioned in a way which does not involve contact and which is reliable and fast.

The devices feature a zinc diecast housing and are often used in connection with a PLC for automatic production processes and machines. For example, they detect objects made from metal, plastic, wood and paper. Transparent films can be detected with the **OR170120** retro-reflective sensor in a way which is clear, reliable and reproducible. Here, the teach-in function enables adaptation to changes to the environmental conditions.

With through-beam sensors, functional monitoring of the sensor is possible through the test input in the **OS170020** transmitter. For this, the operating voltage potential is applied to the corresponding contact.

Although the distance of the diffuse reflection sensor devices can be set using a mechanical setting unit, the high degree of protection (IP67) is maintained. Objects are reliably recogni-

zed, regardless of their color. The functional principle behind these sensing devices is based on the triangulation principle, in which the position of the object is determined by the angle of light reflected from it.

The sensors all work with visible red light and consequently, enable reliable and simple adjustment. The yellow LED display lights up if the output is securely switched. In the case of certain sensors, if the yellow LED flashes when the output is switched, the respective device is working without sufficient functional reserve, e.g. through soiling or maladjustment.

For avoiding reciprocal optical interference, the majority of devices are equipped with interference suppression. As a result, it is possible to mount sensor upon sensor without causing erroneous operations.

application examples

- ▶ presence check of different objects
- ▶ collision avoidance in feed movements
- ▶ control of object and stack heights
- ▶ limit switches, position switches and pulse generators

article-no.	OE170421	OS170020
operating range	3.0m	-
version	through-beam receiver	through-beam transmitter
connection	M12-connector	M12-connector

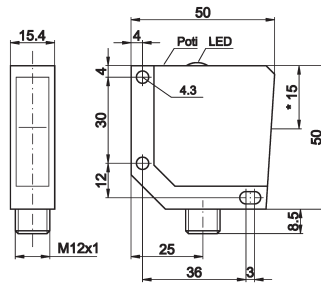

* receiver axis: 15mm

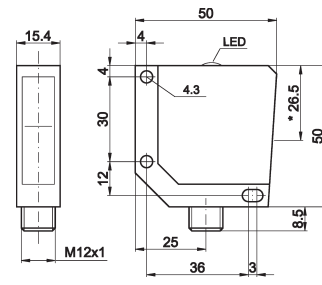

* transmitter axis: 26.5mm

TECHNICAL DATA

operating range	3.0m	-
output signal	pnp, light-on/dark-on mode	-
operating voltage	10 ... 30V DC	10 ... 30V DC
current consumption (w/o load)	≤ 17mA	≤ 30mA
output current (max. load)	200mA	-
voltage drop (max. load)	1.8V DC	-
transmitting element (pulsed)	-	LED, red light
wavelength	-	660nm
sampling frequency	500Hz	-
display (signal)	yellow LED	-
display (soiling)	yellow LED, flashing	-
sensitivity adjustment	potentiometer, 10 revolutions	-
input (function test)	-	operating voltage on contact 4
short-circuit protection	+	-
reverse polarity protection	+	+
dimensions	15.4x50x50mm	15.4x50x50mm
housing material	zinc diecast	zinc diecast
front screen material	plastic PMMA	plastic PMMA
operating temperature	-25 ... +65°C	-25 ... +65°C
degree of protection (EN 60529)	IP67	IP67
connection	M12-connector, 4-pin	M12-connector, 4-pin
connection accessories	e.g. VK200325	e.g. VK200325
mounting accessories (bracket)	e.g. AV000084	e.g. AV000084
mounting accessories (universal holder)	AY000119	AY000119

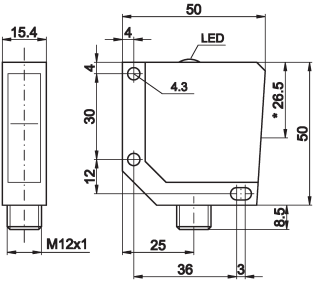
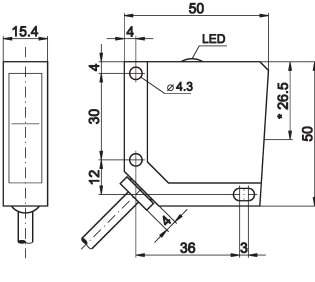
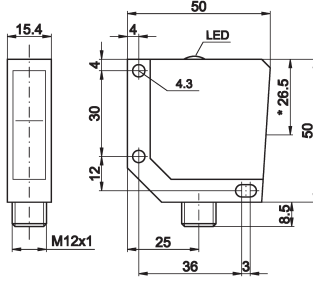
article-no.	OR170120	OR170400	OR170420
operating range	6m (transparent objects)	7m	7m
version	retro-reflective sensor with polarizing filter	retro-reflective sensor with polarizing filter	retro-reflective sensor with polarizing filter
connection	M12-connector	cable	M12-connector
	 <p>* transmitter axis: 26.5mm</p>	 <p>* transmitter axis: 26.5mm</p>	 <p>* transmitter axis: 26.5mm</p>
TECHNICAL DATA			
operating range	6m	7m	7m
output signal	pnp, dark-on mode	pnp, light-on/dark-on mode	pnp, light-on/dark-on mode
operating voltage	10 ... 30V DC	10 ... 30V DC	10 ... 30V DC
current consumption (w/o load)	≤ 50mA	≤ 36mA	≤ 36mA
output current (max. load)	200mA	200mA	200mA
voltage drop (max. load)	1.8V DC	1.8V DC	1.8V DC
transmitting element (pulsed)	LED, red light	LED, red light	LED, red light
wavelength	660nm	660nm	660nm
sampling frequency	200Hz	500Hz	500Hz
display (signal)	yellow LED	yellow LED	yellow LED
display (soiling)	-	yellow LED, flashing	yellow LED, flashing
sensitivity adjustment	external teach-in * (time ≤ 25ms)	-	-
interference suppression	-	+	+
short-circuit protection	+	+	+
reverse polarity protection	+	+	+
dimensions	15.4x50x50mm	15.4x50x50mm	15.4x50x50mm
housing material	zinc diecast	zinc diecast	zinc diecast
front screen material	plastic PMMA	plastic PMMA	plastic PMMA
operating temperature	-25 ... +65°C	-25 ... +65°C	-25 ... +65°C
degree of protection (EN 60529)	IP67	IP67	IP67
connection	M12-connector, 4-pin	2m PVC cable, 4-wire	M12-connector, 4-pin
connection accessories	e.g. VK200325	-	e.g. VK200325
mounting accessories (bracket)	e.g. AV000084	e.g. AV000084	e.g. AV000084
mounting accessories (universal holder)	AY000119	AY000119	AY000119
accessories	AV000114 teach adapter	-	-
<p>* >2s = LED signal reserve: LED flashes fast = high signal reserve LED flashes slow = low signal reserve LED does not flash = malfunction</p>			

article-no.	OT170400	OT170420
sensing range	20 ... 450mm	20 ... 450mm
version	dif. reflection sensor with background suppression	dif. reflection sensor with background suppression
connection	cable	M12-connector

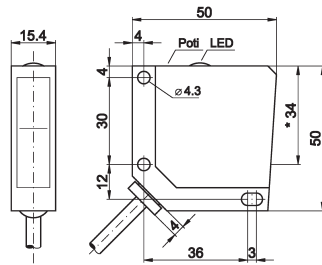

* transmitter axis: 34mm

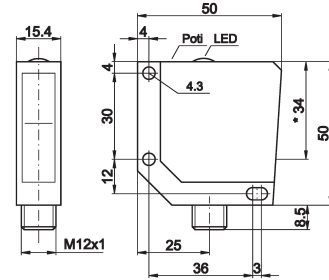

* transmitter axis: 34mm

TECHNICAL DATA

sensing range	20 ... 450mm	20 ... 450mm
output signal	pnp, light-on/dark-on mode	pnp, light-on/dark-on mode
operating voltage	10 ... 30V DC	10 ... 30V DC
current consumption (w/o load)	≤ 41mA	≤ 41mA
output current (max. load)	200mA	200mA
voltage drop (max. load)	1.8V DC	1.8V DC
transmitting element (pulsed)	LED, red light	LED, red light
wavelength	660nm	660nm
sampling frequency	500Hz	500Hz
display (signal)	yellow LED	yellow LED
sensitivity adjustment	mechanical, 5 revolutions	mechanical, 5 revolutions
interference suppression	+	+
short-circuit protection	+	+
reverse polarity protection	+	+
dimensions	15.4x50x50mm	15.4x50x50mm
housing material	zinc diecast	zinc diecast
front screen material	plastic PMMA	plastic PMMA
operating temperature	-25 ... +65°C	-25 ... +65°C
degree of protection (EN 60529)	IP67	IP67
connection	2m PVC cable, 4-wire	M12-connector, 4-pin
connection accessories	-	e.g. VK200325
mounting accessories (bracket)	e.g. AV000084	e.g. AV000084
mounting accessories (universal holder)	AY000119	AY000119

article-no.	OT170421	OT170423
sensing range	20 ... 450mm	20 ... 600mm
version	dif. reflection sensor with background suppression glass front screen	dif. reflection sensor with background suppression
connection	M12-connector	M12-connector
	<p>* transmitter axis: 34mm</p>	<p>* transmitter axis: 34mm</p>
TECHNICAL DATA		
sensing range	20 ... 450mm	20 ... 600mm
output signal	pnp, light-on/dark-on mode	pnp, light-on/dark-on mode
operating voltage	10 ... 30V DC	10 ... 30V DC
current consumption (w/o load)	≤ 41mA	≤ 41mA
output current (max. load)	200mA	200mA
voltage drop (max. load)	1.8V DC	1.8V DC
transmitting element (pulsed)	LED, red light	LED, red light
wavelength	660nm	660nm
sampling frequency	500Hz	100Hz
display (signal)	yellow LED	yellow LED
sensitivity adjustment	mechanical, 5 revolutions	mechanical, 5 revolutions
interference suppression	+	+
short-circuit protection	+	+
reverse polarity protection	+	+
dimensions	15.4x50x50mm	15.4x50x50mm
housing material	zinc diecast	zinc diecast
front screen material	glass	plastic PMMA
operating temperature	-25 ... +65°C	-25 ... +65°C
degree of protection (EN 60529)	IP67	IP67
connection	M12-connector, 4-pin	M12-connector, 4-pin
connection accessories	e.g. VK200325	e.g. VK200325
mounting accessories (bracket)	e.g. AV000084	e.g. AV000084
mounting accessories (universal holder)	AY000119	AY000119

connection

connector devices, light-on and dark-on mode

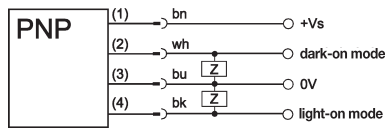

cable devices, light-on and dark-on mode

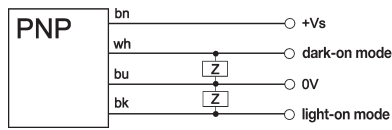

retro-reflective sensor, teach-in, dark-on mode **OR170120**

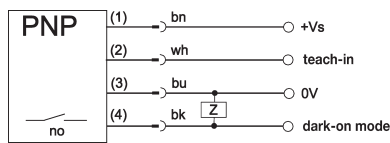

through-beam transmitter, test input **OS170020**

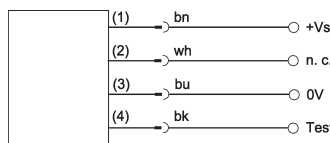

wire colors: bn = brown (1), wh = white (2), bu = blue (3), bk = black (4)

mounting accessories (bracket) **AV000084**

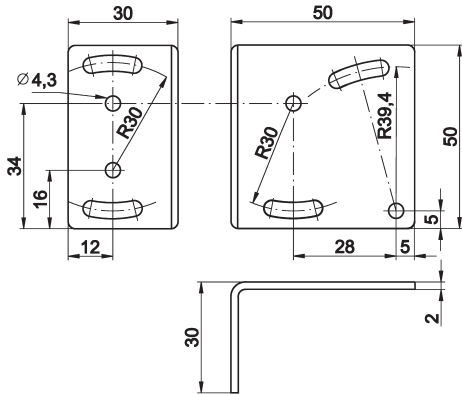

mounting accessories (universal holder) **AY000119**

composed of base module

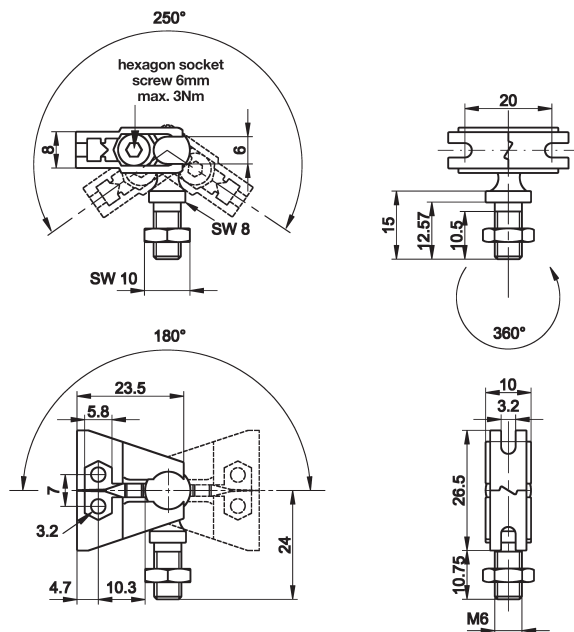

... and fitting panel

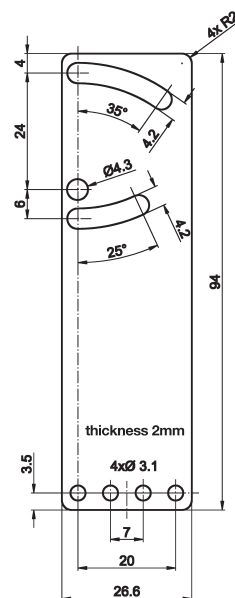

This data sheet contains the standard versions only. Kindly request the availability of other output- and connection functions.

We will be pleased to supply the matching cable socket for your devices with connector. Please refer to the list in catalog chapter „accessories“ under „cable sockets **ipf-SENSORFLEX**“ or search our website for „VK“.

Warning: Never use these devices in applications where the safety of a person depends on their functionality.

This data sheet as well as your personal contact can be found at www.ipf-electronic.com