

design	M18 x 1mm	
through-beam sensor	operating distance	up to 20m
retro-reflective sensor	operating distance	up to 2m
diffuse reflection sensor	sensing range	up to 0.6m

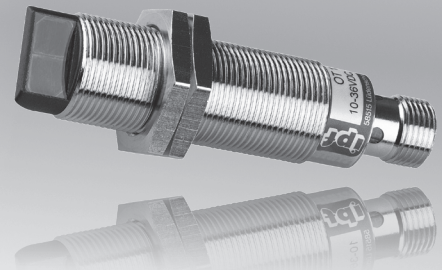

- ✓ **robust metal housing**
- ✓ **glass lens**
- ✓ **integrated amplifier, adjustable diffuse reflection sensor**
- ✓ **diffuse reflection sensor with background suppression by triangulation**
- ✓ **retro-reflective sensor with polarizing filter**
- ✓ **short-circuit and reverse polarity protected**
- ✓ **high sampling frequency and sensing ranges**
- ✓ **visible red light**
- ✓ **connection with cable and M12-connector**

**up to 20m operating distance
lateral light emission**

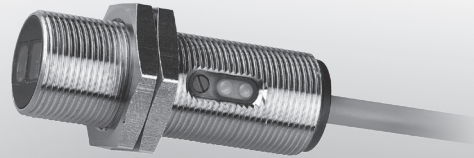
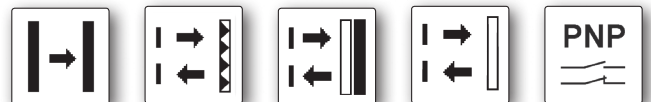

description

Optoelectronic sensors are indispensable components in all automated production processes. They are used in all applications where parts are to be detected, counted, measured or positioned in a way which does not involve contact and which is reliable and fast.

The devices feature a brass housing and are often used in connection with a PLC for automatic production processes and machines. For example, they detect objects made from metal, glass, plastic, wood and paper.

Functional monitoring of the sensor is possible for through-beam sensors using the test input in the transmitter. For this, the operating voltage potential is applied to the corresponding contact.

Objects are reliably recognized, regardless of their color. The functional principle behind these sensing devices is based on

triangulation principle, in which the position of the object is determined by the light reflected from it.

The sensors all work with visible red light and consequently, enable reliable and simple adjustment.

The yellow LED display lights up if the output is securely switched. If the green LED flashes when the output is switched, the respective device is working without sufficient functional reserve, e.g. through soiling or maladjustment.

application examples

- ▶ checking the presence of various objects
- ▶ avoiding collision, in the case of feeding movements
- ▶ monitoring object and stack heights
- ▶ limit switches, position switches and pulse generators

article-no.	OE18040A	OS18000A	OE18042A	OS18002A
version	receiver through-beam sensor	transmitter through-beam sensor	receiver through-beam sensor	transmitter through-beam sensor
operating distance	20m	-	20m	-
output signal	pnp light-on/ dark-on mode	-	pnp light-on/ dark-on mode	-
connection	cable	cable	connector	connector
TECHNICAL DATA				
operating distance	20m	-	20m	-
output signal	pnp light-on/dark-on mode	-	pnp light-on/dark-on mode	-
operating voltage	10 ... 36V DC	10 ... 36V DC	10 ... 36V DC	10 ... 36V DC
current consumption (w/o load)	≤ 10mA	≤ 15mA	≤ 10mA	≤ 15mA
output current (max. load)	200mA	-	200mA	-
voltage drop (max. load)	2.0V DC	-	2.0V DC	-
transmitting element	-	LED, red light	-	LED, red light
wave length (transmitter)	-	660nm	-	660nm
hysteresis	≤ 10%	≤ 10%	≤ 10%	≤ 10%
readiness delay	20ms	20ms	20ms	20ms
sampling frequency	1kHz	-	1kHz	-
display (signal / reserve)	yellow LED / green LED	- / -	yellow LED / green LED	- / -
sensitivity adjustment	-	-	-	-
test input	-	+	-	+
short-circuit protection	+	+	+	+
reverse polarity protection	+	+	+	+
design	M18x1mm	M18x1mm	M18x1mm	M18x1mm
length (thread/complete)	50mm/50mm	50mm/50mm	42mm/63.5mm	42mm/63.5mm
housing material	chrome-plated brass	chrome-plated brass	chrome-plated brass	chrome-plated brass
lens material	glass	glass	glass	glass
operating temperature	-25 ... +55°C	-25 ... +55°C	-25 ... +55°C	-25 ... +55°C
system of protection (EN60529)	IP67	IP67	IP67	IP67
Anschluss	2m PVC-cable, 4-wire	2m PVC-cable, 3-wire	M12-connector, 4-pin	M12-connector, 4-pin
connection accessories	-	-	e.g. VK200325	e.g. VK200025
mounting accessories (universal holder)	AY000117	AY000117	AY000117	AY000117
mounting accessories (clip)	AY000051	AY000051	AY000051	AY000051

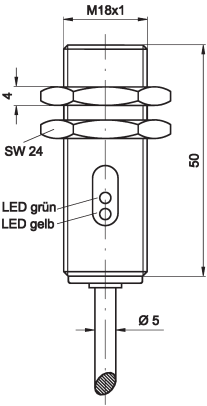
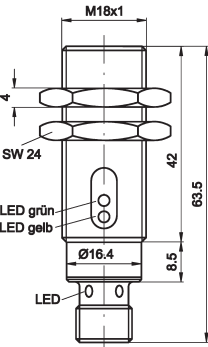
article-no.	OR180106	OR180126
version	retro-reflective sensor polarizing filter	retro-reflective sensor polarizing filter
operating distance	2m	2m
output signal	pnp dark-on mode	pnp dark-on mode
connection	cable	connector
		
TECHNICAL DATA		
operating distance	2m	2m
output signal	pnp dark-on mode	pnp dark-on mode
operating voltage	10 ... 36V DC	10 ... 36V DC
current consumption (w/o load)	≤ 15mA	≤ 15mA
output current (max. load)	200mA	200mA
voltage drop (max. load)	2.0V DC	2.0V DC
transmitting element	red LED	red LED
wavelength (transmitter)	660nm	660nm
hysteresis	≤ 10%	≤ 10%
readiness delay	20ms	20ms
sampling frequency	1kHz	1kHz
display (signal / reserve)	yellow LED / green LED	yellow LED / green LED
sensitivity adjustment	-	-
test input	-	-
short-circuit protection	+	+
reverse polarity protection	+	+
design	M18x1mm	M18x1mm
length (thread/complete)	50mm/50mm	42mm/63.5mm
housing material	chrome-plated brass	chrome-plated brass
lens material	glass	glass
operating temperature	-25 ... +55°C	-25 ... +55°C
system of protection (EN 60529)	IP67	IP67
connection	2m PVC-cable, 3-wire	M12-connector, 3-pin
connection accessories	-	e.g. VK200025
mounting accessories (universal holder)	AY000117	AY000117
mounting accessories (clip)	AY000061	AY000061

article-no.	OT180405	OT180425	OT180106	OT180126
version	dif. reflection sensor	dif. reflection sensor	dif. reflection sensor, back-ground suppression	dif. reflection sensor, back-ground suppression
sensitivity adjustment	potentiometer	potentiometer	potentiometer	potentiometer
sensing range	40 ... 600mm	40 ... 600mm	10 ... 120mm	10 ... 120mm
output signal	pnp light-on/ dark-on mode	pnp light-on/ dark-on mode	pnp light-on mode	pnp light-on mode
connection	cable	connector	cable	connector

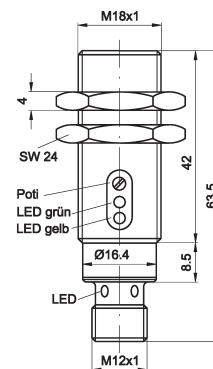
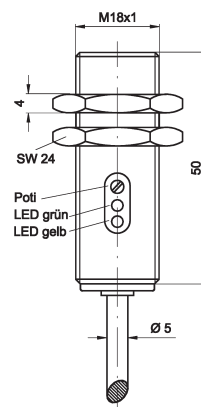
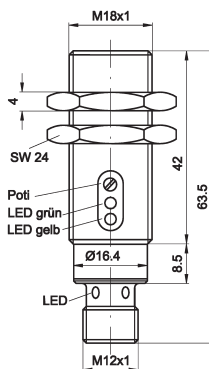
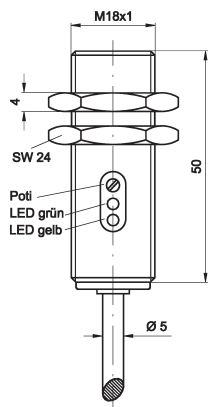

TECHNICAL DATA

sensing range	40 ... 600mm	40 ... 600mm	10 ... 120mm	10 ... 120mm
output signal	pnp light-on/dark-on mode	pnp light-on/dark-on mode	pnp light-on mode	pnp light-on mode
operating voltage	10 ... 36V DC	10 ... 36V DC	10 ... 36V DC	10 ... 36V DC
current consumption (w/o load)	≤ 20mA	≤ 20mA	≤ 25mA	≤ 25mA
output current (max. load)	200mA	200mA	200mA	200mA
voltage drop (max. load)	2.0V DC	2.0V DC	2.0V DC	2.0V DC
transmitting element	red LED	red LED	red LED	red LED
wave length (transmitter)	660nm	660nm	660nm	660nm
norm trimming plate	200x200mm white	200x200mm white	100x100mm white	100x100mm white
hysteresis	≤ 10%	≤ 10%	≤ 10%	≤ 10%
readiness delay	60ms	60ms	20ms	20ms
sampling frequency	1kHz	1kHz	500Hz	500Hz
display (signal / reserve)	yellow LED / green LED	yellow LED / green LED	yellow LED / green LED	yellow LED / green LED
sensitivity adjustment	potentiometer	potentiometer	potentiometer	potentiometer
test input	-	-	-	-
short-circuit protection	+	+	+	+
reverse polarity protection	+	+	+	+
design	M18x1mm	M18x1mm	M18x1mm	M18x1mm
length (thread/complete)	50mm/50mm	42mm/63.5mm	50mm/50mm	42mm/63.5mm
housing material	chrome-plated brass	chrome-plated brass	chrome-plated brass	chrome-plated brass
lens material	glass	glass	glass	glass
operating temperature	-25 ... +55°C	-25 ... +55°C	-25 ... +55°C	-25 ... +55°C
system of protection (EN60529)	IP67	IP67	IP67	IP67
connection	2m PVC-cable, 4-pin	M12-connector, 4-pin	2m PVC-cable, 3-pin	M12-connector, 4-pin
connection accessories	-	e.g. VK200325	-	e.g. VK200025
mounting accessories (universal holder)	AY000117	AY000117	AY000117	AY000117
mounting accessories (clip)	AY000051	AY000051	AY000051	AY000051

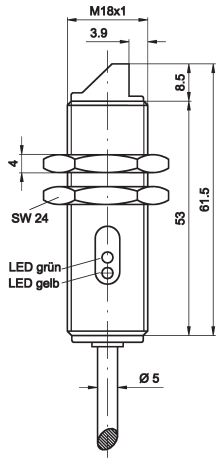
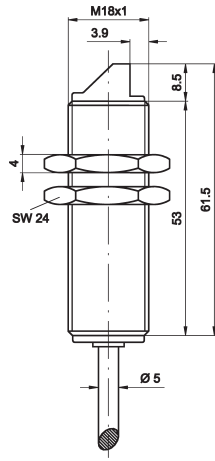
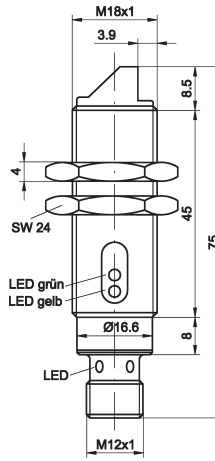
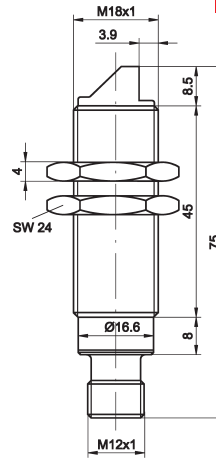
article-no. version	OE18040C receiver through-beam sensor	OS18000C transmitter through-beam sensor	OE18042C receiver through-beam sensor	OS18002C transmitter through-beam sensor
sensitivity adjustment	-	-	-	-
operating distance	20m	-	20m	-
output signal	pnp light-on/ dark-on mode	-	pnp light-on/ dark-on mode	-
connection	cable	cable	connector	connector
				
TECHNICAL DATA				
operating distance	20m	-	20m	-
output signal	pnp light-on/dark-on mode	-	pnp light-on/dark-on mode	-
operating voltage	10 ... 36V DC	10 ... 36V DC	10 ... 36V DC	10 ... 36V DC
current consumption (w/o load)	≤ 10mA	≤ 15mA	≤ 10mA	≤ 15mA
output current (max. load)	200mA	-	200mA	-
voltage drop (max. load)	2.0V DC	-	2.0V DC	-
transmitting element	-	LED, red light	-	LED, red light
wave length (transmitter)	-	660nm	-	660nm
norm trimming plate	-	-	-	-
hysteresis	≤ 10%	≤ 10%	≤ 10%	≤ 10%
readiness delay	20ms	20ms	20ms	20ms
sampling frequency	1kHz	-	1kHz	-
display (signal / reserve)	yellow LED / green LED	yellow LED / -	yellow LED / green LED	yellow LED / -
sensitivity adjustment	-	-	-	-
test input	-	+	-	+
short-circuit protection	+	+	+	+
reverse polarity protection	+	+	+	+
design	M18x1mm	M18x1mm	M18x1mm	M18x1mm
length (thread/complete)	53mm/61.5mm	53mm/61.5mm	45mm/75mm	45mm/75mm
housing material	chrome-plated brass	chrome-plated brass	chrome-plated brass	chrome-plated brass
lens material	glass	glass	glass	glass
operating temperature	-25 ... +55°C	-25 ... +55°C	-25 ... +55°C	-25 ... +55°C
system of protection (EN60529)	IP67	IP67	IP67	IP67
Anschluss	2m PVC-cable, 4-wire	2m PVC-cable, 3-wire	M12-connector, 4-pin	M12-connector, 3-pin
connection accessories	-	-	e.g. VK200325	e.g. VK200025
mounting accessories (universal holder)	AY000117	AY000117	AY000117	AY000117
mounting accessories (clip)	AY000061	AY000061	AY000061	AY000061

article-no.	OR180108	OR180128
version	retro-reflective sensor polarizing filter	retro-reflective sensor polarizing filter
operating distance	2m	2m
output signal	pnp dark-on mode	pnp dark-on mode
connection	cable	connector
TECHNICAL DATA		
operating distance	2m	2m
output signal	pnp dark-on mode	pnp dark-on mode
operating voltage	10 ... 36V DC	10 ... 36V DC
current consumption (w/o load)	≤ 15mA	≤ 15mA
output current (max. load)	200mA	200mA
voltage drop (max. load)	2.0V DC	2.0V DC
transmitting element	red LED	red LED
wavelength (transmitter)	660nm	660nm
norm trimming plate	-	-
hysteresis	≤ 10%	≤ 10%
readiness delay	20ms	20ms
sampling frequency	1kHz	1kHz
display (signal / reserve)	yellow LED / green LED	yellow LED / green LED
sensitivity adjustment	-	-
test input	-	-
short-circuit protection	+	+
reverse polarity protection	+	+
design	M18x1mm	M18x1mm
length (thread/complete)	53mm/61.5mm	45mm/75mm
housing material	chrome-plated brass	chrome-plated brass
lens material	glass	glass
operating temperature	-25 ... +55°C	-25 ... +55°C
system of protection (EN 60529)	IP67	IP67
connection	2m PVC-cable, 3-wire	M12-connector, 3-pin
connection accessories	-	e.g. VK200025
mounting accessories (universal holder)	AY000117	AY000117
mounting accessories (clip)	AY000051	AY000051

article-no.	OT180407	OT180427	OT180108	OT180128
version	dif. reflection sensor	dif. reflection sensor	dif. reflection sensor, back-ground suppression	dif. reflection sensor, back-ground suppression
sensitivity adjustment	potentiometer	potentiometer	potentiometer	potentiometer
sensing range	40 ... 600mm	40 ... 600mm	10 ... 120mm	10 ... 120mm
output signal	pnp light-on/ dark-on mode	pnp light-on/ dark-on mode	pnp light-on mode	pnp light-on mode
connection	cable	connector	cable	connector
TECHNICAL DATA				
sensing range	40 ... 600mm	40 ... 600mm	10 ... 120mm	10 ... 120mm
output signal	pnp light-on/dark-on mode	pnp light-on/dark-on mode	pnp light-on mode	pnp light-on mode
operating voltage	10 ... 36V DC	10 ... 36V DC	10 ... 36V DC	10 ... 36V DC
current consumption (w/o load)	≤ 20mA	≤ 200mA	≤ 25mA	≤ 25mA
output current (max. load)	200mA	200mA	200mA	200mA
voltage drop (max. load)	2.0V DC	2.0V DC	2.0V DC	2.0V DC
transmitting element	red LED	red LED	red LED	red LED
wave length (transmitter)	660nm	660nm	660nm	660nm
norm trimming plate	200x200mm white	200x200mm white	100x100mm white	100x100mm white
hysteresis	≤ 10%	≤ 10%	≤ 10%	≤ 10%
readiness delay	60ms	60ms	20ms	20ms
sampling frequency	1kHz	1kHz	500Hz	500Hz
display (signal / reserve)	yellow LED / green LED	yellow LED / -	yellow LED / green LED	yellow LED / -
sensitivity adjustment	potentiometer	potentiometer	potentiometer	potentiometer
test input	-	+	-	+
short-circuit protection	+	+	+	+
reverse polarity protection	+	+	+	+
design	M18x1mm	M18x1mm	M18x1mm	M18x1mm
length (thread/complete)	53mm/61.5mm	45mm/75mm	53mm/61.5mm	45mm/75mm
housing material	chrome-plated brass	chrome-plated brass	chrome-plated brass	chrome-plated brass
lens material	glass	glass	glass	glass
operating temperature	-25 ... +55°C	-25 ... +55°C	-25 ... +55°C	-25 ... +55°C
system of protection (EN60529)	IP67	IP67	IP67	IP67
connection	2m PVC-cable, 4-pin	M12-connector, 4-pin	2m PVC-cable, 3-pin	M12-connector, 3-pin
connection accessories	-	e.g. VK200325	-	e.g. VK200025
mounting accessories (universal holder)	AY000117	AY000117	AY000117	AY000117
mounting accessories (clip)	AY000061	AY000061	AY000061	AY000061

connection

receiver through-beam sensor, diffuse reflection sensor

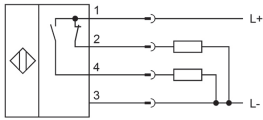

diffuse reflection sensor with background suppression

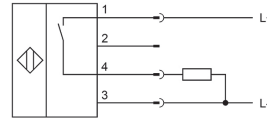

retro-reflective sensor

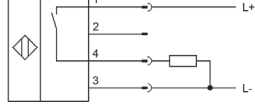

transmitter through-beam sensor

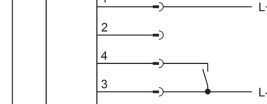

wire colors: bn = brown (1), wh = white (2), bu = blue (3), bk = black (4)

system test: connect the blue (3) and black (4) wire to disable the transmitter of a through-beam sensor.

important note: if a cable socket with LED display has to be used for connection of the sensor, the black wire (4) must be permanently connected to +24V DC to prevent the transmitter being disabled via the LED!

response curves

OS/OE18

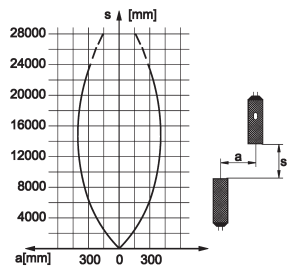

OR18

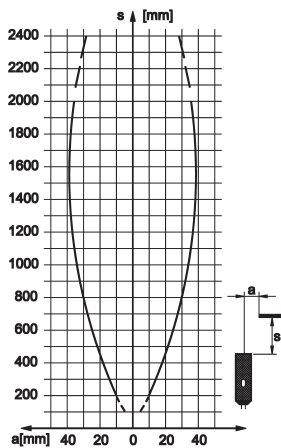

OT18

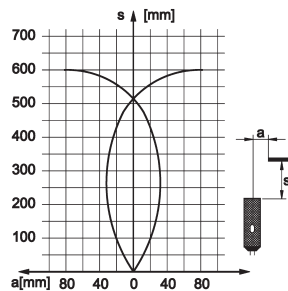

OT18 with background suppression

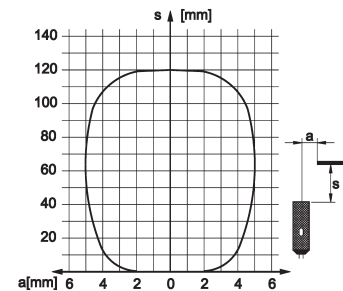

universal holder AY000117
consisting of base module ...

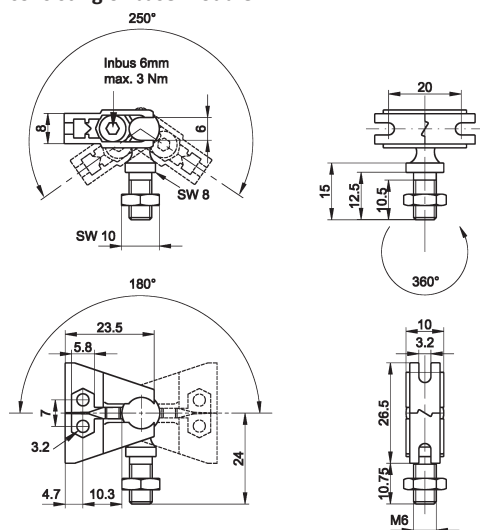

and fitting panel

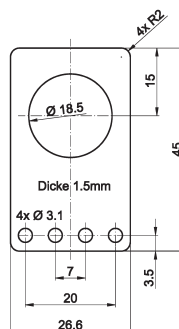

This data sheet contains the standard versions only. Kindly request the availability of other output- and connection functions.

We will be pleased to supply the matching cable socket for your devices with connector. Please refer to the list in catalog chapter „accessories“ under „cable sockets ipf-SENSORFLEX®“ or search our website for „VK“.

Warning: Never use these devices in applications where the safety of a person depends on their functionality.

This data sheet as well as your personal contact can be found at www.ipf.de