

AM000051

ACCESSORIES • LINEAR AND ANGULAR MEASUREMENT



MECHANICAL DATA

Diameter	50 mm
Hole diameter	9
Material	Aluminium

ELECTRICAL DATA

Number of pins	64
Pin length	3.2 mm

DIMENSIONAL DRAWING

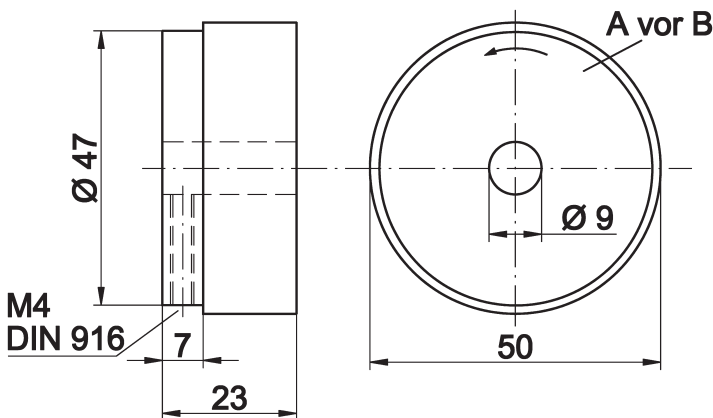

INSTALLATION



Mounting / Installation may only be carried out by a qualified electrician!

DISPOSAL



SAFETY WARNINGS

Before initial operation, please make sure to follow all safety instructions that may be provided in the product

information!

Never use these devices in applications where the safety of a person depends on their functionality.