

design	33.8 x 12 x 16mm to 40 x 57 x 18mm
mounting accessories	threaded sensors M5x0.5 M8x1, M12x1 M8x1
	cuboid sensors IB09, IB16, IB26 Ox11, Ox13, Ox14 Px14, UT14, Ox15 Ox16, Px16, Ox17, Px17 IB21, UT21, UR21 OT37, Ox38, Px38 Ox43, Px43, PT49 OTQ4, OYQ4

- ✓ mountable on plates, profiles and panels with one single screw
- ✓ high mobility level enables simple adjustment of the sensors
- ✓ mounting on a Ø8mm rod possible
- ✓ several mounting options
- ✓ higher operational dependability of the sensors thanks to better and more precise alignment

**universal holder
mounting with one screw**

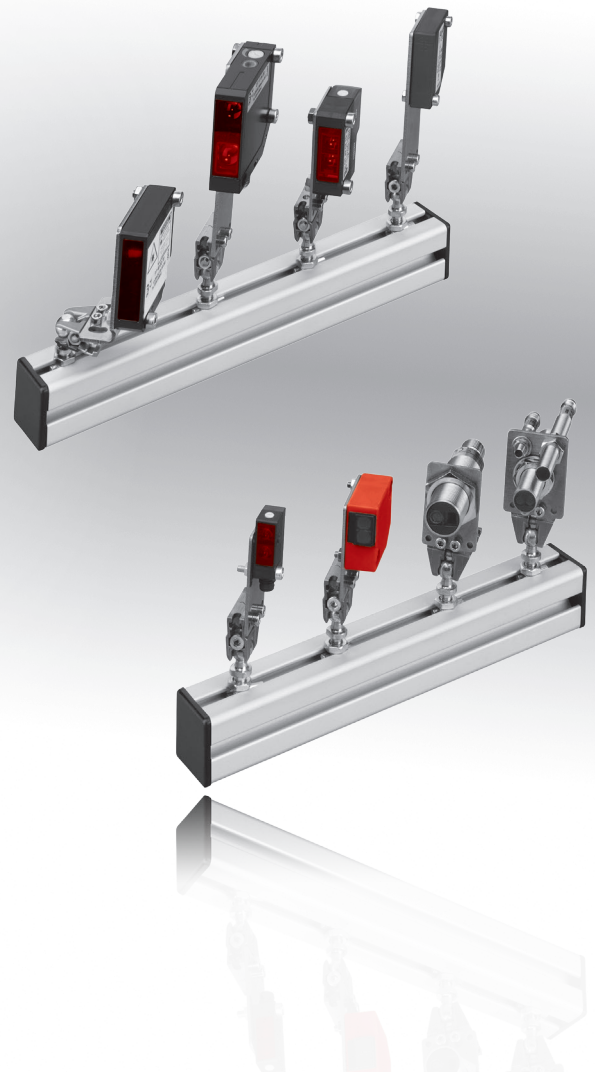

description

The special production of elaborate and costly appropriate sensor holders can be dispensed with through the use of the *ipf* universal holders.

The multi-function base module supplied with a ball joint enables sensors to be mounted quickly and in a way which makes them immovable in any position and orientation.

For this, only the appropriate fastening-parts kit is needed. This

contains the base module **AY000088** with the necessary fitting panel and mounting material.

application examples

- ▶ sensor mounting on panels, rods or profiles
- ▶ adjustment and alignment of sensors

base module AY000088

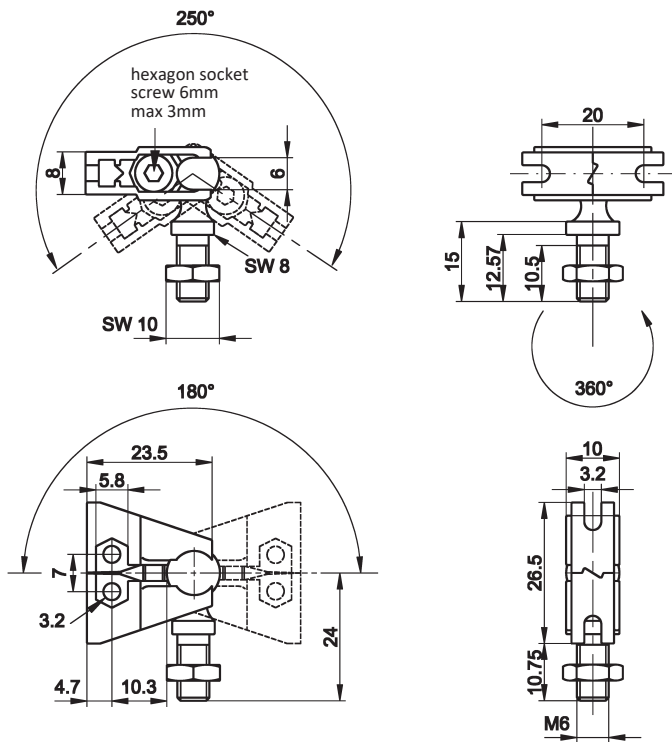

AY000096

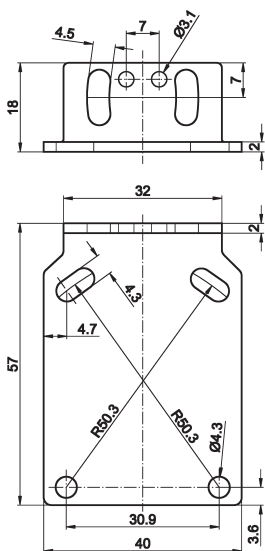

AY000114

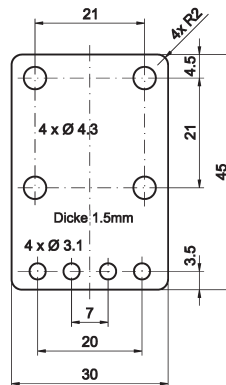

ARTICLE-NO.	DESCRIPTION	MATERIAL
AY000088	base module *	flanges: stainless steel, ball pin: zincd steel
AY000096	fastening parts kit for sensors Px49	stainless steel
AY000114	fastening parts kit for sensors Ox15	stainless steel

* The base module **AY000088** is included in every fastening-parts kit.
Material of the screws and nuts: steel, zincd

AY000115

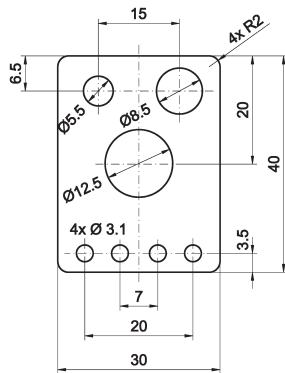

AY000116

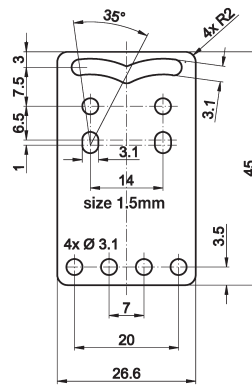

AY000117

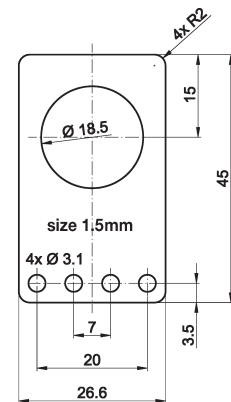

AY000118

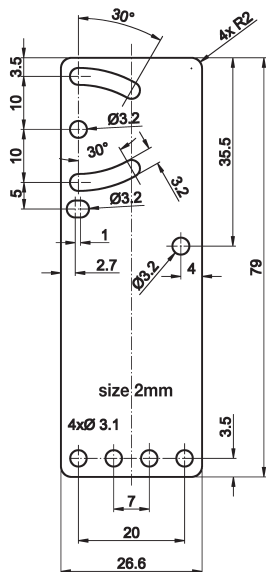

AY000119

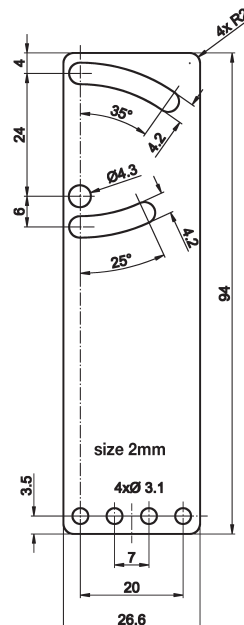

AY000120

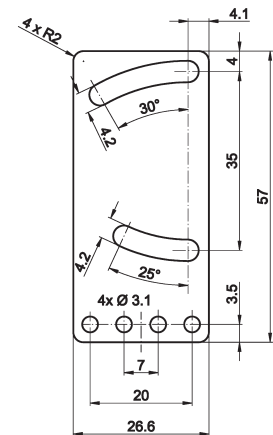

ARTICLE-NO.	DESCRIPTION	MATERIAL
AY000115	fastening parts kit for sensors M5 M8 M12	stainless steel
AY000116	fastening parts kit for sensors IB14 Ox14 Px14 UT14 Ix21 KB21 OTQ4 OTQ9 UR21 UT21	stainless steel
AY000117	fastening parts kit for sensors M18	stainless steel
AY000118	fastening parts kit for sensors Ix09 Ix16 Ix26 Ox16 Px16	stainless steel
AY000119	fastening parts kit for sensors Ox11 Ix13 Ox13 Px13 Ox17 Ox38	stainless steel
AY000120	fastening parts kit for sensors Ox43 Px43	stainless steel

* The base module **AY000088** is included in every fastening-parts kit.
Material of the screws and nuts: steel, zincd

mounting options

rod

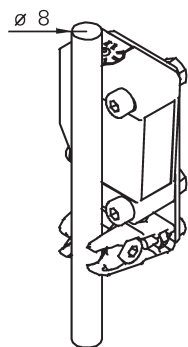

profile

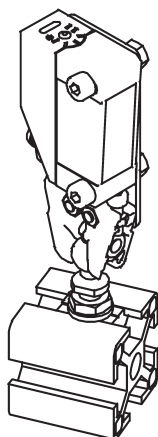

panel

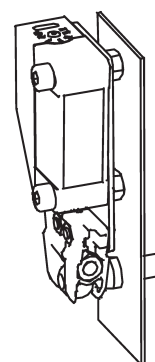

AY000088 3D-view

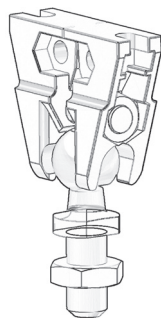

selection chart of the fastening-parts kits for sensors with thread

	AY000115			AY000117
sensors	M5	M8	M12	M18

* The base module **AY000088** is included in every fastening-parts kit.

selection chart of the fastening-parts kits for cuboid sensors

	AY000096	AY000114	AY000116
sensors	PT49	OE15 OR15 OS15 OT15	OE14 OS14 OR14 OT14
		OL15	PE14 PS14 PT14 PK14
			UT14
			IB21 UR21 UT21 OT21
			OTQ4 OTQ9

* The base module **AY000088** is included in every fastening-parts kit.

selection chart of the fastening-parts kits for cuboid sensors

	AY000118	AY000119	AY000120
sensors	IB09	OE11 OS11 OT11	ON43 OK43 OR43 OT43
	IB16	OE13 OR13 OS13 OT13 PE13 PS13	PE43 PS43 PR43 PT43
	IB26	OE17 OR17 OS17 OT17	PK43
	OE16 OS16 OR16 OT16	PK17 PR17 PT17	
	PR16 PT16	OR387 OR38 OT38 OY38	
		PE38 PS38 PT38	

* The base module **AY000088** is included in every fastening-parts kit.