



**HIRSCHMANN**

A **BELDEN** BRAND

# User Manual

## Installation

**MICE Switch Power - MSP30/32/40/42**

**MICE Switch Media modules - MSM20/22/24/40/42/46/50**

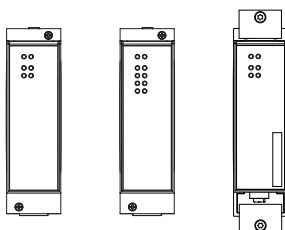
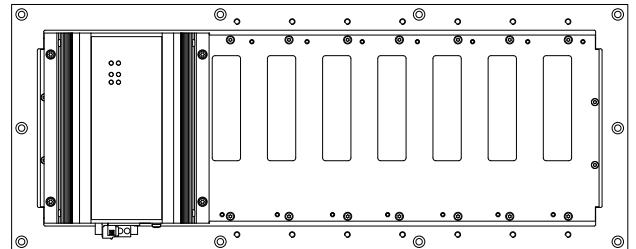
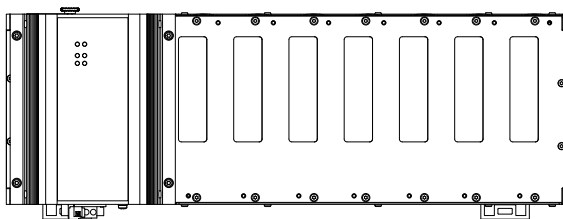
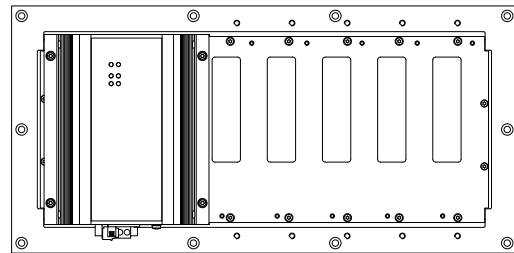
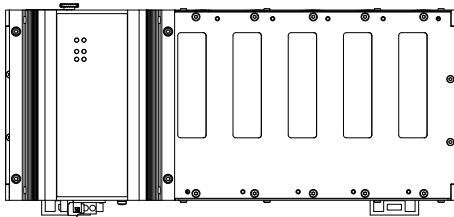
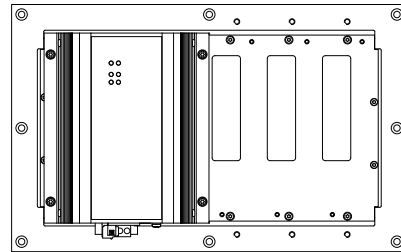
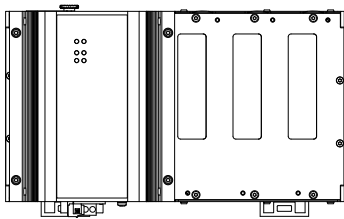

The naming of copyrighted trademarks in this manual, even when not specially indicated, should not be taken to mean that these names may be considered as free in the sense of the trademark and tradename protection law and hence that they may be freely used by anyone.

© 2018 Hirschmann Automation and Control GmbH

Manuals and software are protected by copyright. All rights reserved. The copying, reproduction, translation, conversion into any electronic medium or machine scannable form is not permitted, either in whole or in part. An exception is the preparation of a backup copy of the software for your own use.

The performance features described here are binding only if they have been expressly agreed when the contract was made. This document was produced by Hirschmann Automation and Control GmbH according to the best of the company's knowledge. Hirschmann reserves the right to change the contents of this document without prior notice. Hirschmann can give no guarantee in respect of the correctness or accuracy of the information in this document.

Hirschmann can accept no responsibility for damages, resulting from the use of the network components or the associated operating software. In addition, we refer to the conditions of use specified in the license contract.

You can get the latest version of this manual on the Internet at the Hirschmann product site ([www.hirschmann.com](http://www.hirschmann.com)).

Hirschmann Automation and Control GmbH  
Stuttgarter Str. 45-51  
72654 Neckartenzlingen  
Germany

# Contents

<b>Safety instructions</b>	<b>6</b>
<b>About this manual</b>	<b>17</b>
<b>Key</b>	<b>18</b>
<b>1 Description</b>	<b>19</b>
1.1 General device description	19
1.1.1 Basic device	19
1.1.2 Media modules	19
1.2 Device name and product code	20
1.3 Device views	26
1.3.1 Basic device	26
1.3.2 Media modules	30
1.4 Number of ports and connections	37
1.5 Power supply	39
1.5.1 Supply voltage with the characteristic value C	39
1.5.2 Supply voltage with the characteristic value P	39
1.6 SFP Transceiver	39
1.7 Ethernet ports	39
1.8 Display elements	42
1.8.1 Device state	42
1.8.2 Digital input	43
1.8.3 MSM20 media modules	43
1.8.4 MSM40 media modules	44
1.8.5 MSM22, MSM42 and MSM46 media modules	45
1.8.6 MSM50 media modules	46
1.8.7 MSM24 I/O module	46
1.9 Management interfaces	48
1.9.1 V.24 interface (external management)	48
1.9.2 SD card interface (optional)	48
1.9.3 USB interface	49
1.10 Input/output interfaces	49
1.10.1 Signal contact	49
1.10.2 Digital input	50
<b>2 Installation</b>	<b>51</b>
2.1 Checking the package contents	51
2.2 Installing the SD card (optional)	51

2.3	Installing and grounding the device	52
2.3.1	Installing the device onto the DIN rail	52
2.3.2	Mounting on a flat surface	53
2.3.3	Grounding the device	53
2.4	Connecting the terminal blocks	54
2.4.1	Supply voltage with the characteristic value C	54
2.4.2	Supply voltage with the characteristic value P	55
2.4.3	Signal contact	56
2.5	Connecting the ferrite	56
2.6	Installing terminal blocks, switching on the supply voltage	57
2.7	Installing media modules	57
2.7.1	Device variants featuring customer-specific version with the characteristic value HH	58
2.7.2	Device variants featuring customer-specific version with the characteristic value HX	59
2.7.3	Connecting the external PoE supply voltage of media module MSM46	59
2.8	Connecting an I/O module	60
2.8.1	Connecting actuators and sensors	60
2.9	Installing an SFP transceiver (optional)	61
2.10	Connecting data cables	62
2.10.1	10/100/1000 Mbit/s twisted pair port	63
2.10.2	10/100 Mbit/s twisted pair port	63
2.10.3	1/2.5 Gbit/s F/O port	63
2.10.4	100/1000 Mbit/s F/O port	63
2.10.5	100 Mbit/s F/O port	63
<b>3</b>	<b>Basic Settings</b>	<b>64</b>
<b>4</b>	<b>Monitoring the ambient air temperature</b>	<b>65</b>
<b>5</b>	<b>Upgrading Software</b>	<b>66</b>
<b>6</b>	<b>Maintenance and service</b>	<b>67</b>
<b>7</b>	<b>Disassembly</b>	<b>68</b>
7.1	Removing an SFP transceiver (optional)	68
7.2	Removing a media module	68
7.2.1	Device variants featuring customer-specific version with the characteristic value HH	69
7.2.2	Device variants featuring customer-specific version with the characteristic value HX	70

7.3	Removing the device	70
7.3.1	Device variants featuring customer-specific version with the characteristic value HH	71
7.3.2	Device variants featuring customer-specific version with the characteristic value HX	71
<b>8</b>	<b>Technical data</b>	<b>72</b>
8.1	General technical data	72
8.2	Digital input	75
8.3	Digital output	75
8.4	24 V DC auxiliary voltage (AUX)	76
8.5	External PoE power supply (MSM46)	76
8.6	Dimension drawings	77
8.7	EMC and immunity	82
8.8	Power consumption/power output	85
8.9	Network range	86
<b>9</b>	<b>Scope of delivery, order numbers and accessories</b>	<b>89</b>
9.1	Scope of delivery	89
9.2	Accessories	89
<b>10</b>	<b>Underlying technical standards</b>	<b>92</b>
<b>A</b>	<b>Further support</b>	<b>93</b>

# Safety instructions



## WARNING

### UNCONTROLLED MACHINE ACTIONS

To avoid uncontrolled machine actions caused by data loss, configure all the data transmission devices individually.

Before you start any machine which is controlled via data transmission, be sure to complete the configuration of all data transmission devices.

**Failure to follow these instructions can result in death, serious injury, or equipment damage.**

### ■ General safety instructions

You operate this device with electricity. Improper usage of the device entails the risk of physical injury or significant property damage. The proper and safe operation of this device depends on proper handling during transportation, proper storage and installation, and careful operation and maintenance procedures.

- Before connecting any cable, read this document, and the safety instructions and warnings.
- Operate the device with undamaged components exclusively.
- The device is free of any service components. In case of a damaged or malfunctioning the device, turn off the supply voltage and return the device to Hirschmann for inspection.

### ■ National and international safety regulations

- Verify that the electrical installation meets local or nationally applicable safety regulations.

### ■ Certified usage

- Use the product only for the application cases described in the Hirschmann product information, including this manual.
- Operate the product only according to the technical specifications.  
[See "Technical data" on page 72.](#)
- Connect to the product only components suitable for the requirements of the specific application case.

### ■ Qualification requirements for personnel

- Only allow qualified personnel to work on the device.

Qualified personnel have the following characteristics:

- ▶ Qualified personnel are properly trained. Training as well as practical knowledge and experience make up their qualifications. This is the prerequisite for grounding and labeling circuits, devices, and systems in accordance with current standards in safety technology.
- ▶ Qualified personnel are aware of the dangers that exist in their work.
- ▶ Qualified personnel are familiar with appropriate measures against these hazards in order to reduce the risk for themselves and others.
- ▶ Qualified personnel receive training on a regular basis.

### ■ **Installation site requirements**

- Verify that there is at least 4 in (10 cm) of space above and below the device.
- Verify that there is at least 0.8 in (2 cm) of space on the right and left sides of the device.
- Install the device at ambient temperatures greater than 113 °F (45 °C) in “restricted access locations” based on EN 60950-1 exclusively.

### ■ **Device casing**

Only technicians authorized by the manufacturer are permitted to open the casing.

- Never insert pointed objects (narrow screwdrivers, wires, etc.) into the device or into the connection terminals for electric conductors. Do not touch the connection terminals.
- Make sure there is at least 3.94 in (10 cm) of space in front of the ventilation slits of the casing.
- Keep the ventilation slits free to ensure good air circulation.
- If you are operating the device in a living area or office environment, only operate it in switch cabinets with fire protection characteristics in accordance with EN 60950-1.
- The surfaces of the device housing may become hot. Avoid touching the device while it is operating.

**Note:** The basic device is an inseparable unit. The basic device may be damaged by detachment of the display and connection part.

### ■ **Grounding the device**

Grounding the device is by means of a separate ground connection on the device.

- Ground the device before connecting any other cables.
- Disconnect the grounding only after disconnecting all other cables.

The overall shield of a connected shielded twisted pair cable is connected to the grounding connector on the front panel as a conductor.

## ■ Requirements for connecting electrical wires

Before connecting the electrical wires, **always** verify that the requirements listed are complied with.

### General requirements for connecting electrical wires

The following requirements apply without restrictions:

- ▶ The electrical wires are voltage-free.
- ▶ The cables used are permitted for the temperature range of the application case.
- ▶ Relevant for North America:  
Exclusively use 60/75 °C (140/167 °F) or 75 °C (167 °F) copper (Cu) wire.

### Requirements for connecting the signal contact

The following requirements apply without restrictions:

- ▶ The voltage connected complies with the requirements for a safety extra-low voltage (SELV) as per IEC/EN 60950-1.
- ▶ The connected voltage is limited by a current limitation device or a fuse.  
Observe the electrical threshold values for the signal contact.  
[See "General technical data" on page 72.](#)

### Requirements for connecting the supply voltage

The following requirements apply without restrictions:

All of the following requirements are complied with:

- ▶ The supply voltage corresponds to the voltage specified on the type plate of the device.
- ▶ The power supply conforms to overvoltage category I or II.
- ▶ The power supply has an easily accessible disconnecting device (for example a switch or a plug). This disconnecting device is clearly identified. So in the case of an emergency, it is clear which disconnecting device belongs to which power supply cable.
- ▶ The wire diameter of the power supply cable is at least 1 mm<sup>2</sup> (North America: AWG16) on the supply voltage input.

The following requirements apply alternatively:

Relevant when the device is supplied via 1 voltage input:

Alternative 1 The power supply complies with the requirements for a limited power source (LPS) as per EN 60950-1.

Alternative 2 Relevant for North America:  
The power supply complies with the requirements according to NEC Class 2.

Alternative 3 All of the following requirements are complied with:

- ▶ The power supply complies with the requirements for a safety extra-low voltage (SELV) as per IEC/EN 60950-1.
- ▶ A fuse suitable for DC voltage is located in the plus conductor of the power supply.  
The minus conductor is on ground potential. Otherwise, a fuse is also located in the minus conductor.  
Regarding the properties of this fuse:  
[See "Technical data" on page 72.](#)

Relevant when the device is supplied via 2 voltage inputs:

Alternative 1 The **total** voltage supply meets the requirements for a limited power source (LPS) as per EN 60950-1.

Alternative 2 Relevant for North America:  
The **total** voltage supply complies with the requirements as per NEC Class 2.



## Requirements for connecting the supply voltage

- Alternative 3 **All** of the following requirements are complied with:
- ▶ The power supply complies with the requirements for a safety extra-low voltage (SELV) as per IEC/EN 60950-1.
  - ▶ A fuse suitable for DC voltage is located at both voltage inputs in the plus conductor of the power supply.  
The minus conductor is on ground potential at both voltage inputs.  
Otherwise, a fuse is also located in the minus conductor.  
Regarding the properties of this fuse:  
[See "Technical data" on page 72.](#)

### ■ ESD Guidelines

The modules are equipped with electrostatically sensitive components. These can be destroyed, or their life cycles reduced, by the effects of an electrical field or by a charge equalization if the connections are touched. You will find information about electrostatically endangered assemblies in DIN EN 61340-5-1 (2007-08) and DIN EN 61340-5-2 (2007-08).

### ■ CE marking

The labeled devices comply with the regulations contained in the following European directive(s):

2011/65/EU (RoHS)

Directive of the European Parliament and of the Council on the restriction of the use of certain hazardous substances in electrical and electronic equipment.

2014/30/EU (EMC)

Directive of the European Parliament and the council for standardizing the regulations of member states with regard to electromagnetic compatibility.

In accordance with the above-named EU directive(s), the EU conformity declaration will be at the disposal of the relevant authorities at the following address:

Hirschmann Automation and Control GmbH  
Stuttgarter Str. 45-51  
72654 Neckartenzlingen  
Germany  
[www.hirschmann.com](http://www.hirschmann.com)

The device can be used in the industrial sector.

- ▶ Interference immunity: EN 61000-6-2
- ▶ Emitted interference: EN 55032
- ▶ Reliability: EN 60950-1

You find more information on technical standards here:

[See "Technical data" on page 72.](#)

**Warning!** This is a class A device. This device can cause interference in living areas, and in this case the operator may be required to take appropriate measures.

**Note:** The assembly guidelines provided in these instructions must be strictly adhered to in order to observe the EMC threshold values.

### ■ **LED or laser components**

LED or LASER components according to IEC 60825-1 (2014):

CLASS 1 LASER PRODUCT

CLASS 1 LED PRODUCT

LED CLASS 1 - CLASS 1 LED PRODUCT, relevant for the following F/O modules (indicated by the module code): M2, M4.

LASER CLASS 1 - CLASS 1 LASER PRODUCT, relevant for the following F/O modules (indicated by the module code): S2, S4, G2, L2, C1.

For a description of the nomenclature for module codes, see [table 2 on page 22](#).

### ■ **FCC note:**

This device complies with part 15 of the FCC rules. Operation is subject to the following two conditions: (1) this device may not cause harmful interference; (2) this device must accept any interference received, including interference that may cause undesired operation.

Appropriate testing has established that this device fulfills the requirements of a class A digital device in line with part 15 of the FCC regulations.

These requirements are designed to provide sufficient protection against interference when the device is being used in a business environment.

The device creates and uses high frequencies and can also radiate these frequencies. If it is not installed and used in accordance with this operating manual, it can cause radio transmission interference. The use of this device in a residential area can also cause interference, and in this case the user is obliged to cover the costs of removing the interference.

### ■ **Recycling note**

After usage, this device must be disposed of properly as electronic waste, in accordance with the current disposal regulations of your county, state, and country.

**The following approvals are only in place for the media modules MSM20/24/40/42 in connection with a MSP30/32/40/42 basic device:**

■ **Relevant for use as industrial switching equipment (according to standards UL 508 / CSA C22.2 No. 142-1987)**

When using the MSP30/32/40/42 devices as industrial control equipment the following restrictions apply:

Max. ambient air temperature: +140 °F (+60 °C)

(... applies to operating temperature characteristic values S, T or E)

Exclusively use copper conductors.

Temperature rating of field installed conductors: Exclusively use +167° F (+75 °C) conductors.

Exclusively use +167 °F (+75 °C) copper conductors.

Exclusively for use in Pollution degree 2 environment.

Digital output:

Basic devices MSP30/32/40/42 - Relay (Fault): max. 30 V DC, 1 A, resistive load.

Media module MSM24 - (O1, ..., O4): max. 30 V DC, 1 A, resistive load.

■ **Relevant for use in explosion hazard areas (Hazardous Locations, Class I, Division 2)**

When using the MSP30/32/40/42 devices as industrial control equipment the following restrictions apply:

This equipment is suitable for use in Class I, Division 2, Groups A, B, C, D – OR non-hazardous locations, if labeled “FOR USE IN HAZARDOUS LOCATIONS”.

Additional to the restrictions regarding UL 508, the following restrictions apply:

Ta: –40 °F ... +140°F (–40 °C ... +60 °C), temperature code: T4 for temperature range characteristic values T and E

Ta: +32 °F ... +140 °F (0 °C ... +60 °C), temperature code: T4 for temperature range characteristic value S.

WARNING – EXPLOSION HAZARD – Do not disconnect equipment unless power has been removed or the area is known to be non-hazardous.

WARNING – EXPLOSION HAZARD – Substitution of any components may impair suitability for Class I, Division 2.

 – Apply Control Drawing No. 000172287DNR for installation and use of the MSP basic devices. You find further information on the following pages.

 – Apply Control Drawing No. 000172850DNR for installation and use of the MSM24 I/O modules. You find further information on the following pages.



– Secure the SD card with the thumb screw. Do not connect or disconnect the SD card unless the area is known to be non-hazardous. Connection or disconnection in an explosive atmosphere could result in an explosion.

Notice: For information about the position on the device see [“View from above” on page 29](#).

**Avertissement** - Risque d'explosion - Ne pas débrancher tant que le circuit est sous tension à moins que l'emplacement soit connu pour ne contenir aucune concentration de gaz inflammable.

**Avertissement** - Risque d'explosion - La substitution de tout composant peut rendre ce matériel incompatible pour une utilisation en classe I, division 2.

**Ordinary Location, Non-Hazardous Area, Non-explosive Atmosphere**

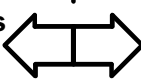

**Hazardous Location Class I, Division 2, Groups A, B, C, D**

The USB connector and the V.24 connector (RJ45) are for temporary connection only. Do not use, connect, or disconnect unless area is known to be non-hazardous. Connection or disconnection in an explosive atmosphere could result in an explosion.

Non-incendive field wiring parameters: THE RELAY TERMINALS ARE DEPENDENT UPON THE FOLLOWING ENTITY PARAMETERS: \*)

U <sub>i</sub>	I <sub>i</sub>	C <sub>i</sub>	L <sub>i</sub>
30 V	90 mA	5nF	1 μH

The earth conductor must be at least of the same wire size (mm<sup>2</sup> or AWG) as the supply conductors.

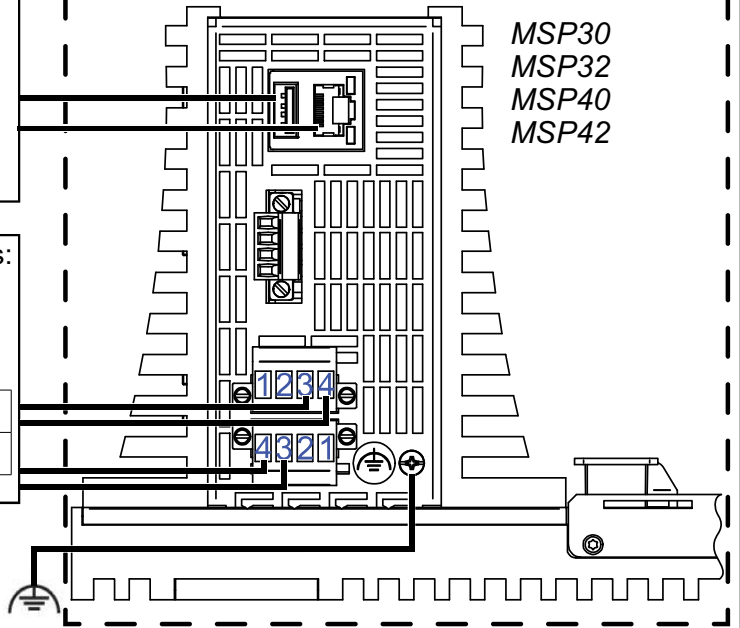

**For use in Hazardous Locations Class I, Division 2, Groups A, B, C, D:**  
**Only allowed for MSP30/32/40/42 model numbers which are individually labelled:**  
**“FOR USE IN HAZARDOUS LOCATIONS”**



**Non-incendive field wiring circuits must be wired in accordance with the National Electrical Code (NEC), NFPA 70, article 501.**

**WARNING - EXPLOSION HAZARD – SUBSTITUTION OF ANY COMPONENTS MAY IMPAIR SUITABILITY FOR HAZARDOUS LOCATIONS OR EXPLOSIVE ATMOSPHERES.**

**WARNING - EXPLOSION HAZARD - DO NOT DISCONNECT EQUIPMENT UNLESS POWER HAS BEEN SWITCHED OFF OR THE AREA IS KNOWN TO BE NON-HAZARDOUS.**

\*) Notes:

The non-incendive field wiring circuit concept allows interconnection of non-incendive field wiring apparatus and associated non-incendive field wiring apparatus using any of the wiring methods permitted for unclassified locations when certain parametric conditions are met.

**Capacity:  $C_a \geq C_i + C_{Cable}$  ; Inductivity:  $L_a \geq L_i + L_{Cable}$**

The maximum cable length has to be determined as follows:

**(a) max. Cable length  $< (L_a - L_i) / Cable_L$**

(“Cable<sub>L</sub>” denotes the inductance per unit length of used cable) and

**(b) max. Cable length  $< (C_a - C_i) / Cable_C$**

(“Cable<sub>C</sub>” denotes the capacitance per unit length of used cable).

**The lower value of (a) and (b) is to apply.**

Manufactured in D-72654 Neckartenzlingen (Germany) by Hirschmann Automation and Control GmbH. DOM: ww/yyyy (Date of manufacture: w - week, y - year. Refer to the device label.)

CONTROL DRAWING for MSP30/32/40/42 devices for use in Hazardous Locations Class I, Division 2, Groups A, B, C, D



Version 2

Document no.: 000172843DNR

Page 1/1

Class I Division 2, Groups A, B, C, D  
Hazardous Location

Ordinary Location, Non-Hazardous Area,  
Nonexplosive Atmosphere



Detail of MSM24-IOIOIOIO

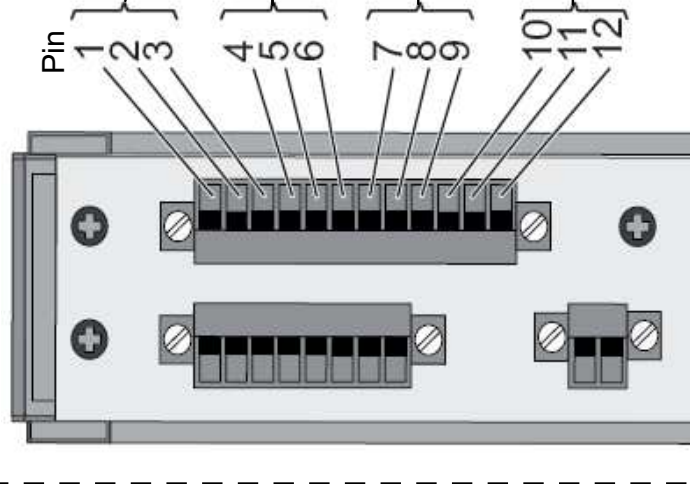

Nonincendive field wiring parameters:  
THE RELAY TERMINALS ARE DEPENDENT  
UPON THE FOLLOWING  
ENTITY PARAMETERS: \*)



U <sub>i</sub>	I <sub>i</sub>	C <sub>i</sub>	L <sub>i</sub>
30 V	90 mA	5 nF	1 μH

The Entity Parameters are to apply to  
the following pin combinations:  
pin 2 and pin 1; pin 2 and pin 3,  
pin 5 and pin 4; pin 5 and pin 6,  
pin 8 and pin 7; pin 8 and pin 9,  
pin 11 and pin 10; pin 11 and pin 12.

**CONTROL DRAWING for MSM24-IOIOIOIO devices**  
for Use in Hazardous Locations  
Class I Division 2, Groups A, B, C, D

Rev. 0

Document No.:000172850DNR



**HIRSCHMANN**  
A BELDEN BRAND

Page 1/2

**For Use in Hazardous Locations Class I Division 2 Groups A, B, C, D:**  
**Only allowed for MSP30 or MS32 model No's. which are individually labelled "FOR USE IN HAZARDOUS LOCATIONS"**  
 Nonincendive field wiring circuits must be wired in accordance with the  
 National Electrical Code (NEC), NFPA 70 , article 501.



**WARNING - EXPLOSION HAZARD – SUBSTITUTION OF ANY COMPONENTS MAY IMPAIR SUITABILITY FOR HAZARDOUS LOCATIONS OR EXPLOSIVE ATMOSPHERES.**

**WARNING - EXPLOSION HAZARD - DO NOT DISCONNECT EQUIPMENT UNLESS POWER HAS BEEN SWITCHED OFF OR THE AREA IS KNOWN TO BE NON-HAZARDOUS.**

**\*) Notes:**

The nonincendive field wiring circuit concept allows interconnection of nonincendive field wiring apparatus and associated nonincendive field wiring apparatus using any of the wiring methods permitted for unclassified locations when certain parametric conditions are met.

**Capacity:**  $C_a \geq C_i + C_{\text{Cable}}$  ; **Inductivity:**  $L_a \geq L_i + L_{\text{Cable}}$

**The maximum cable length** has to be determined as follows:

**(a) max. Cable Length** < **max. Cable Length** <  $(L_a - L_i)$  / **Cable L**  
 ("Cable L" denotes the inductance per unit length of used cable) and

**(b) max. Cable Length** < **max. Cable Length** <  $(C_a - C_i)$  / **Cable c**  
 ("Cable c" denotes the capacitance per unit length of used cable).

**The lower value of (a) and (b) is to apply.**

Manufactured in 72654 Neckartenzlingen / Germany by Hirschmann Automation and Control GmbH.  
 DOM: ww/yyyy (Date of manufacture w - week, Y - year. Refer to the device label).

<b>CONTROL DRAWING for MSM24-IOIOIO devices</b> for Use in Hazardous Locations Class I Division 2 , Groups A, B, C, D	 <b>HIRSCHMANN</b> <small>A BELDEN BRAND</small>
Rev. 0	Document No.: 000172850DNR
Page 2/2	

## ■ ATEX directive 2014/34/EU – specific regulations for safe operation

In Ex zone 2, only devices with a corresponding label may be operated. When operating the devices and modules in Ex zone 2, the following applies:



II 3G

Ex nA IIC T4 Gc

Ta: -40 °C ... +70 °C for characteristic values T and E for temperature range

Ta: 0 °C ... +60 °C for characteristic value S for temperature range

DEKRA 13ATEX0090 X

---

Temperature code T4

---

List of	EN 60079-0: 2012
standards:	EN 60079-15: 2010

---

DO NOT OPEN THE DEVICE WHEN IT IS ELECTRICALLY CHARGED. THE USB CONNECTOR MUST NOT BE USED WHEN THE DEVICE IS OPERATED IN EXPLOSIVE HAZARDOUS LOCATIONS.

### **Special conditions for safe use**

- The basic devices and media modules shall be installed in a suitable enclosure providing a degree of protection of at least IP54 according to EN 60079-15, taking into account the ambient conditions under which the equipment will be used.
- When the temperature under rated conditions exceeds 158 °F (70 °C) on the cable or at conduit entry point, or 176 °F (80 °C) at the branching point of the conductors, take measures so that the temperature specification of the selected cable is in compliance with the actual measured temperature values.
- Provisions shall be made to prevent the rated voltage from being exceeded by transient disturbances of more than 119 V.
- If an SD card is used, it has to be secured with a knurled screw. For information about the position on the device see [“View from above” on page 29](#).



# About this manual

The “Installation” user manual contains a device description, safety instructions, a description of the display, and the other information that you need to install the device.

The following manuals are available as PDF files on the Internet on the Hirschmann product pages ([www.hirschmann.com](http://www.hirschmann.com)):

- ▶ User Manual Installation
- ▶ Basic Configuration user manual
- ▶ Redundancy Configuration user manual
- ▶ Reference manual for the graphical user interface
- ▶ Command Line Interface reference manual

# Key

The symbols used in this manual have the following meanings:

▶	Listing
□	Work step
■	Subheading

# 1 Description

## 1.1 General device description

The MSP30/32/40/42 and MSM20/22/24/40/42/46/50 devices are designed for the special requirements of industrial automation. They meet the relevant industry standards, provide very high operational reliability, even under extreme conditions, and also long-term reliability and flexibility.

The devices allow you to set up switched industrial Ethernet networks that conform to the IEEE 802.3 standard.

The devices work without a fan.

You have the option of choosing various media to connect to the end devices and other network components:

- ▶ multimode F/O
- ▶ singlemode F/O
- ▶ twisted pair cable

The devices provide you with a large range of functions, which the manuals for the operating software inform you about. You find these manuals in the form of PDF files for downloading on the Internet on the Hirschmann product pages ([www.hirschmann.com](http://www.hirschmann.com)).

The Hirschmann network components help you ensure continuous communication across all levels of the company.

The Industrial HiVision Network Management software provides you with additional options for smooth configuration and monitoring: You find further information on the Internet at the Hirschmann product pages:

[www.hirschmann.com/en/Hirschmann\\_Produkte/Industrial\\_Ethernet/network-management-software/index.phtml](http://www.hirschmann.com/en/Hirschmann_Produkte/Industrial_Ethernet/network-management-software/index.phtml)

### 1.1.1 Basic device

There are convenient options for managing the device. Manage your devices via:

- ▶ network management software (for example Industrial HiVision)
- ▶ Web browser
- ▶ V.24 interface (locally on the device)
- ▶ HiDiscovery (software for putting the device into operation)
- ▶ SSH
- ▶ Telnet

### 1.1.2 Media modules

The media modules form the interface from the device to the LAN.

The media modules have different interface types. The different interfaces of the media modules provide you with the following functions:

- ▶ Specific functions of the TP/TX interface
  - ▶ Auto Polarity Exchange
  - ▶ Autocrossing (device may be connected with a crossed-over or an uncrossed cable)
  - ▶ Autonegotiation (selecting the operating mode: speed/duplex)
  - ▶ Link Control
- ▶ Specific functions of the F/O interface
  - ▶ Link Down monitoring

## 1.2 Device name and product code



The device name corresponds to the product code. The product code is made up of characteristics with defined positions. The characteristic values stand for specific product properties.

You have numerous options of combining the device characteristics. You can determine the possible combinations using the Configurator which is available in the Belden E-Catalog ([www.e-catalog.beldensolutions.com](http://www.e-catalog.beldensolutions.com)) on the web page of the device.

### ■ Basic device

Item	Characteristic	Characteristic value	Description
1 ... 3	Product	MSP	MICE Switch Power
4	Data rate	3	10 <sup>a</sup> /100 Mbit/s ports 10 <sup>a</sup> /100/1000 Mbit/s ports
		4	10 <sup>a</sup> /100/1000 Mbit/s ports 1000/2500 Mbit/s ports
5	Hardware type	0	Standard
		2	Suitable for PoE or PoE+
6	(hyphen)	-	
7 ... 8	Number: 10 <sup>a</sup> /100 Mbit/s ports	00	0 ×
		08	8 ×
		16	16 ×
		24	24 ×
9 ... 10	Number: 10 <sup>a</sup> /100/1000 Mbit/s ports	04	4 ×
		12	8 × + 4 × 1000/2500 Mbit/s ports
		20	16 × + 4 × 1000/2500 Mbit/s ports
		28	24 × + 4 × 1000/2500 Mbit/s ports

Table 1: Device name and product code

Item	Characteristic	Characteristic value	Description
11	Number: 10 <sup>a</sup> /100/1000/10000 Mbit/s ports	0	0 ×
12	Temperature range	S	Standard +32 °F ... +140 °F (0 °C ... +60 °C)
		T	Extended -40 °F ... +158 °F (-40 °C ... +70 °C) under UL conditions: max. +140 °F (+60 °C)
		E	Extended with Conformal Coating -40 °F ... +158 °F (-40 °C ... +70 °C) under UL conditions: max. +140 °F (+60 °C)
13	Supply voltage	C	2 voltage inputs for redundant power supply Rated voltage range 24 V DC ... 48 V DC
		P	PoE  2 voltage inputs for redundant power supply Rated voltage range 45 V DC ... 57 V DC
		PoE+  2 voltage inputs for redundant power supply Rated voltage range 51 V DC ... 57 V DC	
14 ... 15	Certificates and declarations	<b>Note:</b> You will find detailed information on the certificates and declarations applying to your device in a separate overview. <a href="#">See table 3 on page 24.</a>	
16 ... 17	Software packages	99	Reserved
		UR	Unicast Routing
		MR	Unicast + Multicast Routing
18 ... 19	Customer-specific version	HH	Hirschmann standard
		HX	Hirschmann Extreme Conditions
20	Software configuration	E	Entry (Hirschmann Standard)
		B	Diagnostic User (DBDEW)
		I	Ethernet/IP
		P	Profinet
21 ... 22	Software level	2A	HiOS Layer 2 Advanced
		3A	HiOS Layer 3 Advanced
23 ... 27	Software version	06.0.	Software version 06.0
		XX.X	Current software version

*Table 1: Device name and product code*

a. Only for twisted pair connections

## ■ Media modules

Item	Characteristic	Characteristic value	Description	
1 ... 3	Product	MSM	MICE Switch Media Module	
4	Data rate	2	10 <sup>a</sup> /100 Mbit/s ports	
		4	10 <sup>a</sup> /100/1000 Mbit/s ports	
		5	1000/2500 Mbit/s ports	
5	Hardware type	0	Standard	
		2	Suitable for PoE or PoE+	
		4	Suitable for I/O operation	
		6	suitable for PoE or PoE+ with external power supply	
6	(hyphen)	-		
7 ... 8	Port 1	T1	Twisted Pair (TX) RJ45 socket	
		T5	Twisted Pair (TX) M12 socket	
		M2	Multimode FX DSC (100 Mbit/s only)	
		M4	Multimode FX ST (100 Mbit/s only)	
		S2	Singlemode FX DSC (100 Mbit/s only)	
		S4	Singlemode FX ST (100 Mbit/s only)	
		L2	Singlemode Long Haul FX DSC (100 Mbit/s only)	
		G2	Singlemode Long Haul FX DSC 200 km (100 Mbit/s only)	
		C1	Combo port: Twisted Pair (TX) F/O	RJ45 socket SFP slot
		IO	Digital Input/Output	
		Q6	SFP slot	1000/2500 Mbit/s
99	Not present			
9 ... 10	Port 2		See items 7 ... 8	
11 ... 12	Port 3		See items 7 ... 8	
13 ... 14	Port 4		See items 7 ... 8	
15	Temperature range	S	Standard	+32 °F ... +140 °F (0 °C ... +60 °C)
		T	Extended	-40 °F ... +158 °F (-40 °C ... +70 °C) under UL conditions: max. +140 °F (+60 °C)
		E	Extended with Conformal Coating	-40 °F ... +158 °F (-40 °C ... +70 °C) under UL conditions: max. +140 °F (+60 °C)
16 ... 17	Certificates and declarations	You will find detailed information on the certificates and declarations applying to your device in a separate overview. <a href="#">See table 4 on page 25.</a>		
18 ... 19	Customer-specific version	HH	Hirschmann standard	
		HX	Hirschmann Extreme Conditions	
20	Hardware configuration	9	none	

Table 2: Device name and product code

Item	Characteristic	Characteristic value	Description
21	Software configuration	E	Entry (Hirschmann Standard)
22 ... 26	Software version	99.9	Without software

*Table 2: Device name and product code*

- a. Only for twisted pair connections

## ■ Basic device

Application case	Certificates and declarations	Characteristic value <sup>a</sup>														
		T9	TY	U9	UW	UX	UY	V9	VT	VU	VY	W9	WY	X9	Y9	Z9
Standard applications	ATEX Zone 2															
	CE	X	X	X	X	X	X	X	X	X	X	X	X	X	X	X
	EN 60950-1	X	X	X	X	X	X	X	X	X	X	X	X	X	X	X
	EN 61131-2	X	X	X	X	X	X	X	X	X	X	X	X	X	X	X
	FCC	X	X	X	X	X	X	X	X	X	X	X	X	X	X	X
	ISA-12.12.01 – Class I, Div. 2					X								X		
	UL 508		X		X	X	X		X	X	X		X	X	X	
Substation applications	IEC 61850-3								X	X	X	X				
	IEEE 1613								X	X	X	X				
Navy applications	DNV GL			X	X	X	X				X					
Railway applications	EN 50121-4	X	X							X						

*Table 3: Assignment: application cases, certificates and declarations, characteristic values*

a. X= Approval or self-declaration present



## ■ Media modules

Application case	Certificates and declarations	Characteristic value <sup>a</sup>														
		T9	TY	U9	UW	UX	UY	V9	VT	VU	VY	W9	WY	X9	Y9	Z9
Standard applications	ATEX Zone 2				#							#	#			
	CE	X	X	X	X	X	X	X	X	X	X	X	X	X	X	X
	EN 60950-1	X	X	X	X	X	X	X	X	X	X	X	X	X	X	X
	EN 61131-2	X	X	X	X	X	X	X	X	X	X	X	X	X	X	X
	FCC	X	X	X	X	X	X	X	X	X	X	X	X	X	X	X
	ISA-12.12.01 – Class I, Div. 2					#									#	
	UL 508		X		X	X	X		X	X	X		X	X	X	
Substation applications	IEC 61850-3								X	X	X	X				
	IEEE 1613								X	X	X	X				
Navy applications	DNV GL			X	X	X	X				X					
Railway applications	EN 50121-4	X	X							X						

*Table 4: Assignment: application cases, certificates and declarations, characteristic values*

- a. X= Approval or self-declaration present  
# = Approval or self-declaration only present for MSM20/24/40/42

## 1.3 Device views

### 1.3.1 Basic device

#### ■ Front view

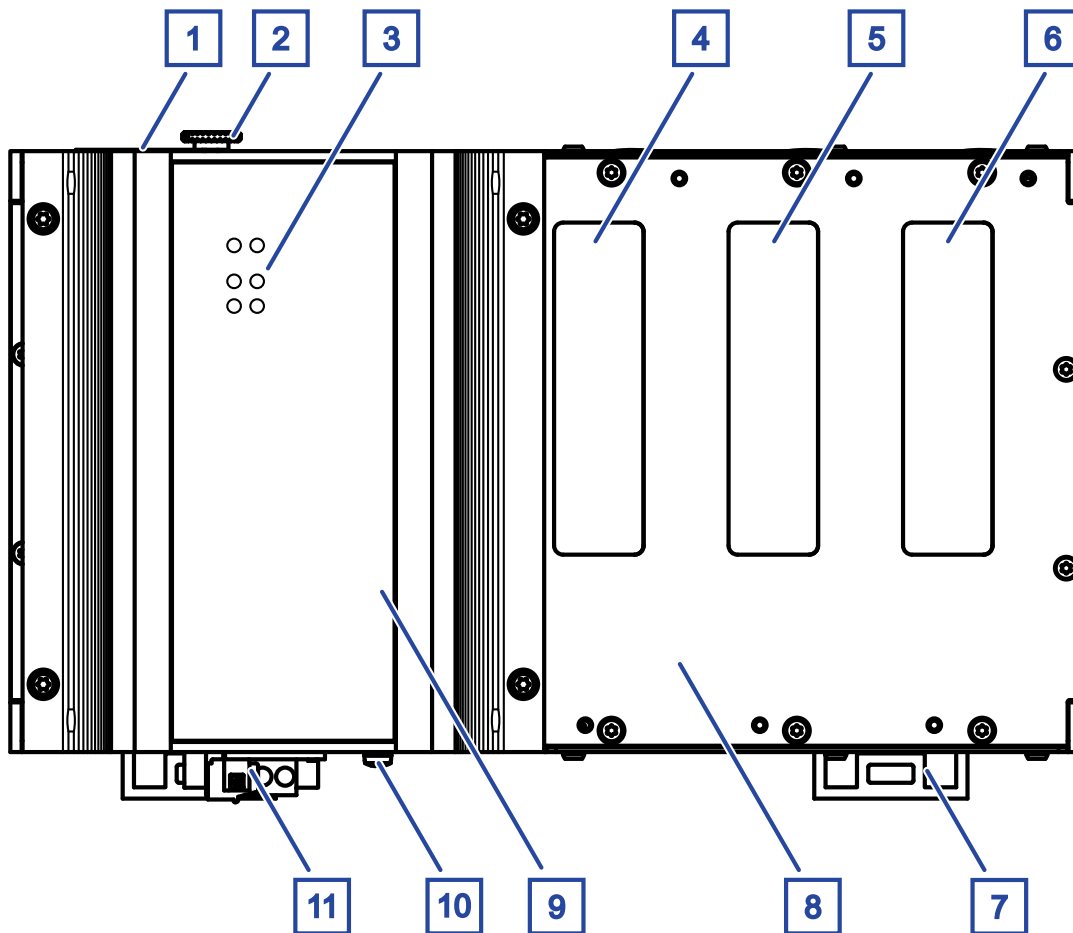

1	Slot for the SD card
2	Thumb screw
3	LED display elements for device status
4	Slot 1 for media modules
5	Slot 2 for media modules
6	Slot 3 for media modules
7	Locking gate for removing the device
8	Backplane (Basic device MSP30/32/40/42)
9	Power module (Basic device MSP30/32/40/42)
10	Grounding screw
11	Terminal block, V.24 port, USB port, signal contacts

Table 5: Front view (using the example MSP30/32-0804.....HH...)

**Note:** On the basic device MSP40/42, the media module slot 1 is coded differently from the other slots. Only MSM50 media modules can be installed on this media module slot.

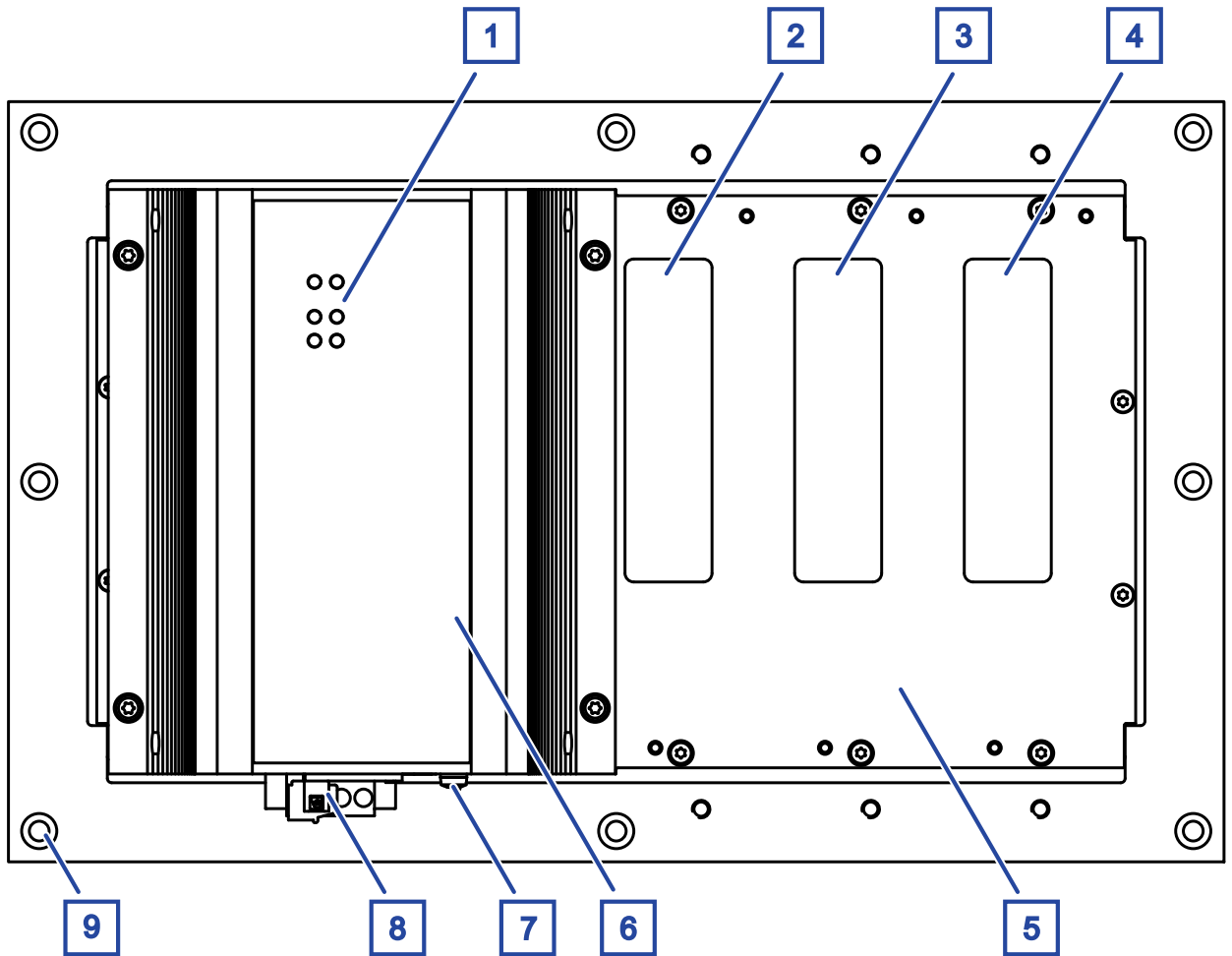

1	LED display elements for device status
2	Slot 1 for media modules
3	Slot 2 for media modules
4	Slot 3 for media modules
5	Backplane (Basic device MSP30)
6	Power module (Basic device MSP30)
7	Grounding screw
8	Terminal block, V.24 port, USB port, signal contacts
9	Fastening hole

Table 6: Front view (using the example MSP30-0804.....HX...)

## ■ View from below

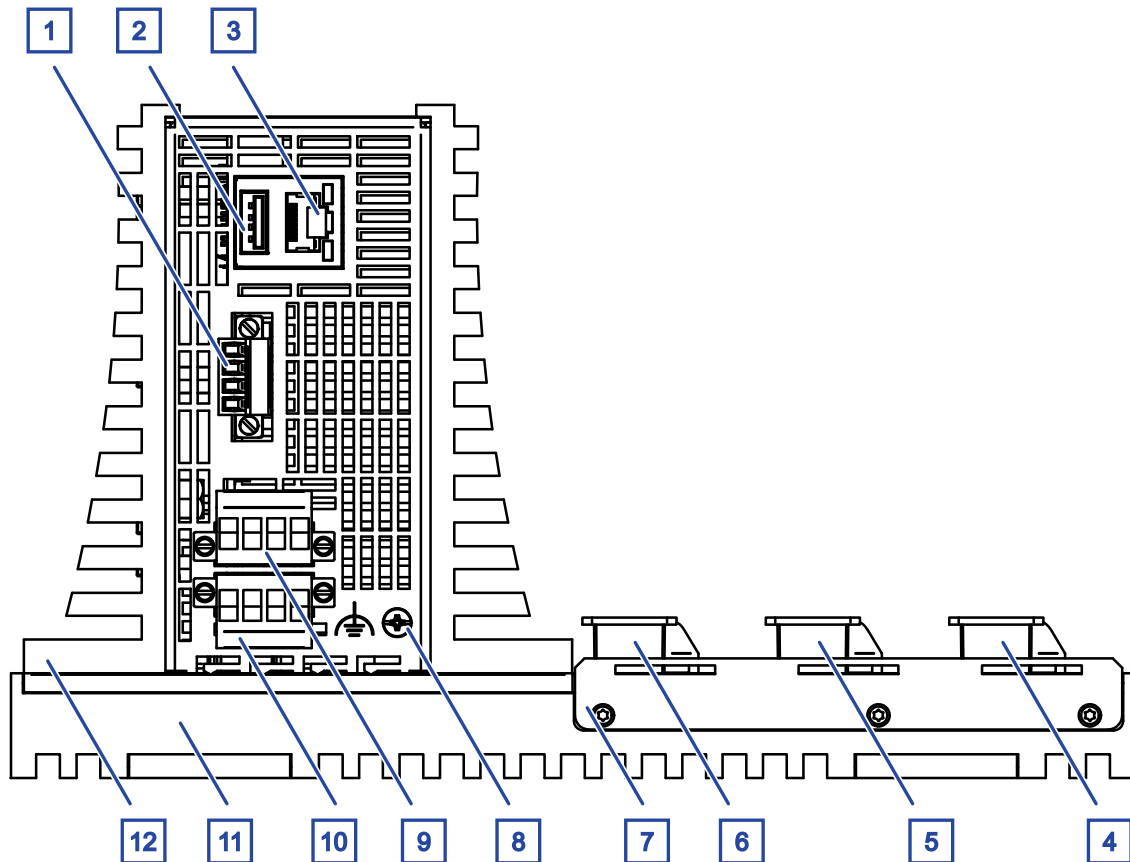

1	Connection for 2 digital inputs	
2	USB interface	The device supports the ACA21/ACA22 starting with the software version 3.0.
3	V.24 interface	LED display elements are not functional in the existing device version.
4	Slot 3 for media modules	
5	Slot 2 for media modules	
6	Slot 1 for media modules	
7	Positioning bar	
8	Grounding screw	
9	Supply voltage connection	<ul style="list-style-type: none"> <li>▶ Connection for the signal contact</li> <li>▶ Low voltage input</li> <li>▶ Voltage input for redundant power supply</li> <li>▶ 4-pin terminal block</li> </ul>
10	Supply voltage connection	<ul style="list-style-type: none"> <li>▶ Connection for the signal contact</li> <li>▶ Low voltage input</li> <li>▶ Voltage input for redundant power supply</li> <li>▶ 4-pin terminal block</li> </ul>
11	Backplane	(Basic device MSP30/32/40/42)
12	Power module	(Basic device MSP30/32/40/42)

Table 7: Bottom view (using the example MSP30/32-0804.....HH...)

**Note:** On the basic device MSP40/42, the media module slot 1 is coded differently from the other slots. Only MSM50 media modules can be installed on this media module slot.

## ■ View from above

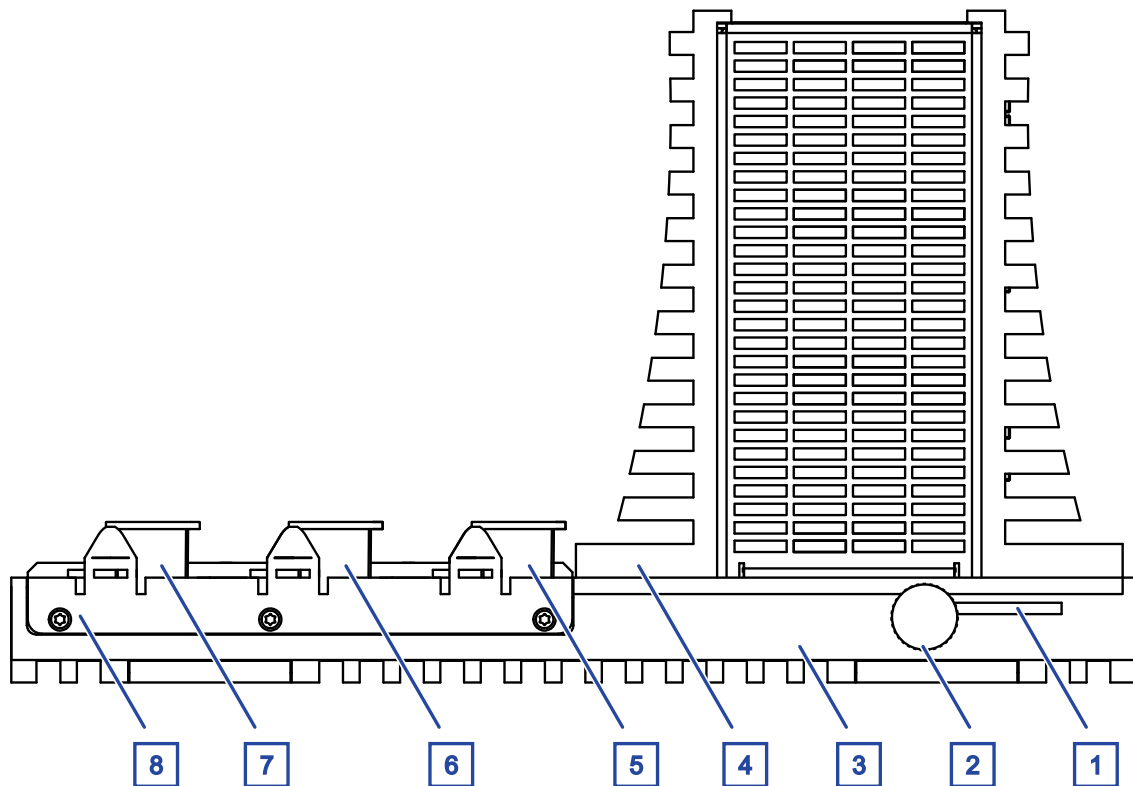

1	Slot for the SD card
2	Thumb screw
3	Backplane (Basic device MSP30/32/40/42)
4	Power module (Basic device MSP30/32/40/42)
5	Slot 1 for media modules
6	Slot 2 for media modules
7	Slot 3 for media modules
8	Female multipoint connector

*Table 8: View from above (using the example MSP30/32-0804.....HH...)*

**Note:** On the basic device MSP40/42, the media module slot 1 is coded differently from the other slots. Only MSM50 media modules can be installed on this media module slot.

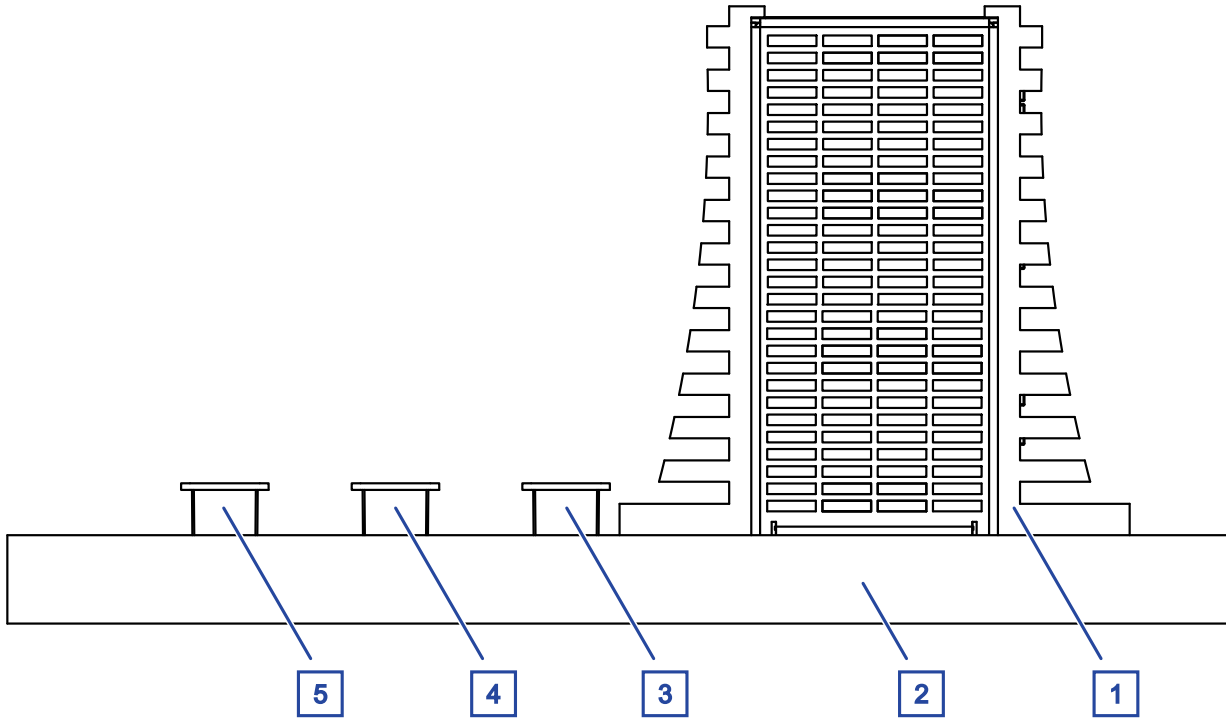

1	Power module	(Basic device MSP30)
2	Backplane	(Basic device MSP30)
3	Slot 1 for media modules	
4	Slot 2 for media modules	
5	Slot 3 for media modules	

Table 9: View from above (using the example MSP30-0804.....HX...)

### 1.3.2 Media modules

#### Media modules MSM20

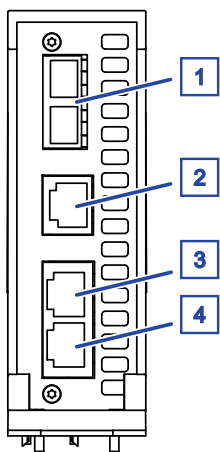

1	Port 1	(F/O)
2	Port 2	(Twisted Pair)
3	Port 3	(Twisted Pair)
4	Port 4	(Twisted Pair)

Table 10: MSM20-S2T1T1T1...

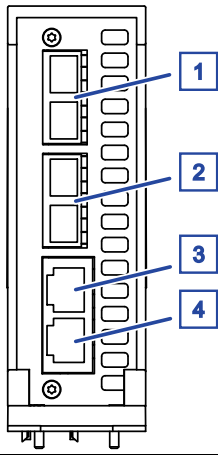

1	Port 1 (F/O)
2	Port 2 (F/O)
3	Port 3 (Twisted Pair)
4	Port 4 (Twisted Pair)

Table 11: MSM20-S2S2T1T1...

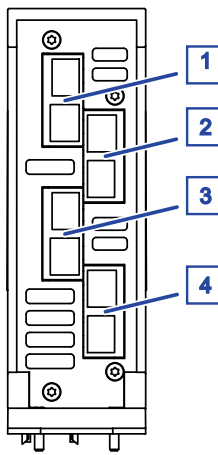

1	Port 1 (F/O)
2	Port 2 (F/O)
3	Port 3 (F/O)
4	Port 4 (F/O)

Table 12: MSM20-S4S4S4S4...

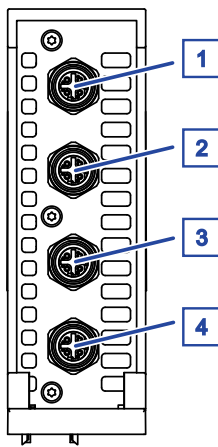

1	Port 1 (Twisted Pair)
2	Port 2 (Twisted Pair)
3	Port 3 (Twisted Pair)
4	Port 4 (Twisted Pair)

Table 13: MSM20-T5T5T5T5...

## Media modules MSM40

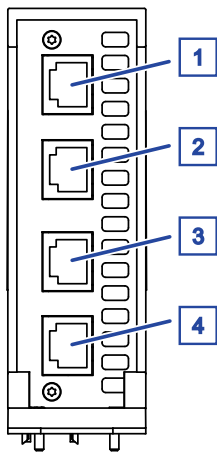

1	Port 1 (Twisted Pair)
2	Port 2 (Twisted Pair)
3	Port 3 (Twisted Pair)
4	Port 4 (Twisted Pair)

Table 14: MSM40-T1T1T1T1...

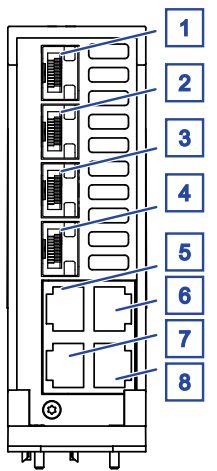

1	Port 1 (F/O)
2	Port 2 (F/O)
3	Port 3 (F/O)
4	Port 4 (F/O)
5	Port 1 (Twisted Pair)
6	Port 2 (Twisted Pair)
7	Port 3 (Twisted Pair)
8	Port 4 (Twisted Pair)

Table 15: MSM40-C1C1C1C1...

The combo port media module MSM40-C1C1C1C1... has 4 twisted pair ports and 4 F/O slots (connection option with SFP transceivers). You have the option of alternatively connecting a twisted pair cable via a RJ45 socket or an optical fiber via a SFP transceiver to a combo port. By inserting a SFP transceiver, you deactivate automatically the corresponding twisted pair interface.



## ■ PoE-capable media modules MSM22, MSM42 and MSM46

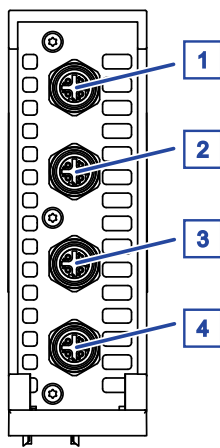

1	Port 1	(Twisted Pair)
2	Port 2	(Twisted Pair)
3	Port 3	(Twisted Pair)
4	Port 4	(Twisted Pair)



Table 16: MSM22-T5T5T5T5...

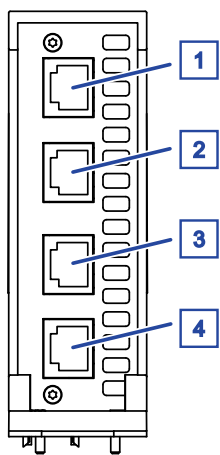

1	Port 1	(Twisted Pair)
2	Port 2	(Twisted Pair)
3	Port 3	(Twisted Pair)
4	Port 4	(Twisted Pair)



Table 17: MSM42-T1T1T1T1...

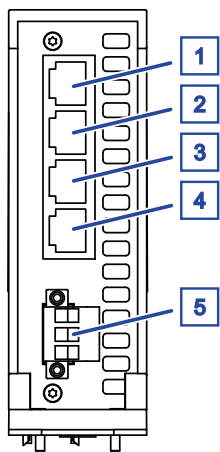

1	Port 1	(Twisted Pair)
2	Port 2	(Twisted Pair)
3	Port 3	(Twisted Pair)
4	Port 4	(Twisted Pair)
5	3-pin terminal block for the PoE supply voltage	



Table 18: MSM46-T1T1T1T1...

The MSM22, MSM42 and MSM46 PoE media modules support Power over Ethernet (PoE) according to IEEE 802.3af and Power over Ethernet Plus (PoE+) according to IEEE 802.3at.

The PoE ports allow the connection and remote supply of, for example, IP telephones (Voice over IP), webcams, sensors, printer servers and WLAN access points. With PoE, power is supplied to these terminal devices through the twisted pair cable.

The PoE support complies with the following technical standards:

Standard	Description	
IEEE 802.3af	Brief description	PoE
	Classes	max. Powered Device (PD) class 0 (15,4 W)
IEEE 802.3at	Brief description	PoE+
	Classes	max. Powered Device (PD) class 4 (30 W)

Table 19: PoE support: technical standards

In accordance with IEEE 802.3af and IEEE 802.3at:

- ▶ Endpoint PSE
- ▶ Alternative A.

The following applies to PoE ports:

- ▶ The PoE power is supplied via the wire pairs transmitting the signal (phantom voltage).
- ▶ The individual ports (joint PoE voltage) are not electrically insulated from each other.

**Note:** The basic devices MSP32 and MSP42 support a PoE power budget of 120 W. You cannot expand the PoE power budget of the MSP basic devices with MSM46-T1T1T1T1... media modules.

You find the maximum PoE power output in [table 45 on page 86](#).

**Note:** The PoE/PoE+ power supply of the PoE media module MSM46-T1T1T1T1... takes place using an external power supply unit. The external power supply unit for the PoE supply voltage is connected to the device via a 3-pin terminal block. When you install the media module MSM46-T1T1T1T1... on a MSP basic device without internal PoE power supply (MSP30, MSP40), the media module allows you to supply external devices with PoE voltage.

In the following table you find more information on the pin assignment of the external supply voltage of the media module MSM46:

Figure	Pin	
	1	Case
	2	GND
	3	54 V DC

Table 20: 3-pin terminal block pin assignment

## ■ MSM24 I/O module

Figure	Item	Function	
	1	Input (I)	Input
	2	Output (O)	Output
	3	AUX	Auxiliary voltage

Table 21: MSM24-IOIOIOIO...

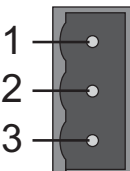
The MSM24 I/O module has 4 electrically insulated digital inputs and outputs according to the technical standard EN 61131-2. Through these inputs, the I/O module receives and transmits digital sensor signals. The digital outputs allow a wide range of actuators to be operated in the plant area.

Sensors, actuators and other components are supplied with +24 V DC via an electrically insulated output.

On the bottom of the I/O module there are terminal blocks for connecting the

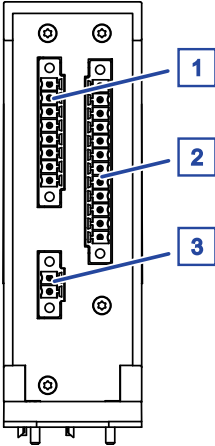
- ▶ digital inputs (I)
- ▶ digital outputs (O)
- ▶ 24 V DC auxiliary voltage

The pin assignment is shown on the front cover of the I/O module, adjacent to the LEDs.

In the following overview you find more information on the pin assignment.

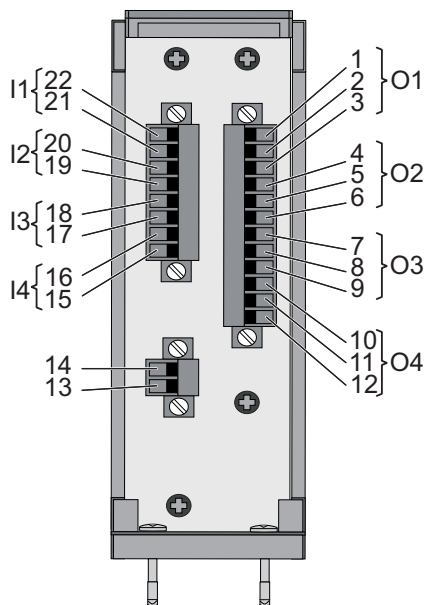

Pin	Signal, terminal	Function
1	OFF-1	NC contact, channel 1
2	CENTER-1	Center contact, channel 1
3	ON-1	NO contact, channel 1
4	OFF-2	NC contact, channel 2
5	CENTER-2	Center contact, channel 2
6	ON-2	NO contact, channel 2
7	OFF-3	NC contact, channel 3
8	CENTER-3	Center contact, channel 3
9	ON-3	NO contact, channel 3
10	OFF-4	NC contact, channel 4
11	CENTER-4	Center contact, channel 4
12	ON-4	NO contact, channel 4

Table 22: Pin assignment of the digital outputs

Pin	Signal, terminal	Function
13	AUX_GND	Reference potential
14	AUX_+24 V	Auxiliary voltage

Table 23: Pin assignment of the auxiliary voltage connection

Pin	Signal, terminal	Function
15	IN-4-GND	Reference potential, channel 4
16	IN-4	Signal input, channel 4
17	IN-3-GND	Reference potential, channel 3
18	IN-3	Signal input, channel 3
19	IN-2-GND	Reference potential, channel 2
20	IN-2	Signal input, channel 2
21	IN-1-GND	Reference potential, channel 1
22	IN-1	Signal input, channel 1

Table 24: Pin assignment of the digital inputs

## Media module MSM50

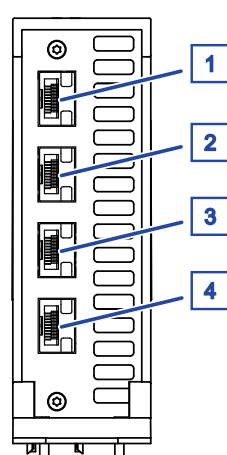

1	Port 1	SFP slot
2	Port 2	SFP slot
3	Port 3	SFP slot
4	Port 4	SFP slot

Table 25: MSM50-Q6Q6Q6Q6...

The media module MSM50-Q6Q6Q6Q6... has 4 SFP slots for 1/2.5 Gbit/s F/O connections (connection via SFP transceivers).

**Note:** On the basic device MSP40/42, the media module slot 1 is coded differently from the other slots. Only MSM50 media modules can be installed on this media module slot.

## 1.4 Number of ports and connections

Depending on their variant, the basic devices offer you the following number of slots for media modules and the following maximum amount of connectable network segments:

Basic device	Total number of slots	Number of slots for 10/100 Mbit/s (FE)	Number of slots for 1000 Mbit/s (GE)	Max. number of connectable 10/100 Mbit/s network segments	Max. number of connectable 1000 Mbit/s network segments
MSP30-0804... MSP32-0804...	3	2	1	12	4
MSP30-1604... MSP32-1604...	5	4	1	20	4
MSP30-2404... MSP32-2404...	7	6	1	28	4

Table 26: Number of slots and maximum connectable network segments

Basic device	Total number of slots	Number of slots for 100/1000 Mbit/s (GE)	Number of slots for 100/1000 Mbit/s (GE)	Max. number of connectable 100/1000 Mbit/s network segments	Max. number of connectable 1000/2500 Mbit/s network segments
MSP40-0012... MSP42-0012...	3	2	1	8	4
MSP40-0020... MSP42-0020...	5	4	1	16	4
MSP40-0028... MSP42-0028...	7	6	1	24	4

Table 27: Number of slots and maximum connectable network segments

The maximum data rate of the media modules depends on their slot on the basic device. Some media modules only support data rates up to 10/100 Mbit/s.

See [“Device name and product code” on page 20.](#)

You will find the arrangement and sequence of the slots on the basic device in the following overview:

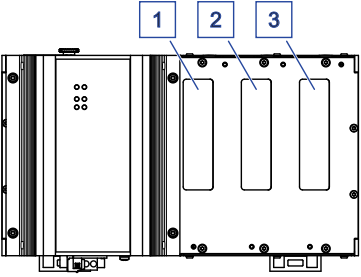
Slots	MSP30/32-2404...	MSP40/42-0028...
	1 10 <sup>a</sup> /100/1000 Mbit/s	1000/2500 Mbit/s
	2 10 <sup>a</sup> /100 Mbit/s	10 <sup>a</sup> /100/1000 Mbit/s
	3 10 <sup>a</sup> /100 Mbit/s	10 <sup>a</sup> /100/1000 Mbit/s

a. Only for twisted pair connections.

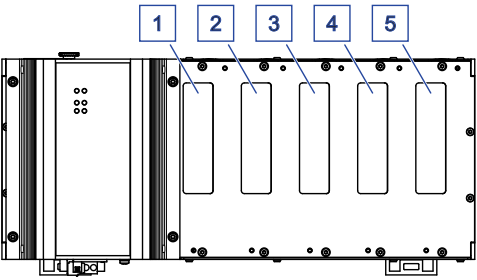
Slots	MSP30/32-2404...	MSP40/42-0028...
	1 10 <sup>a</sup> /100/1000 Mbit/s	1000/2500 Mbit/s
	2 10 <sup>a</sup> /100 Mbit/s	10 <sup>a</sup> /100/1000 Mbit/s
	3 10 <sup>a</sup> /100 Mbit/s	10 <sup>a</sup> /100/1000 Mbit/s
	4 10 <sup>a</sup> /100 Mbit/s	10 <sup>a</sup> /100/1000 Mbit/s
	5 10 <sup>a</sup> /100 Mbit/s	10 <sup>a</sup> /100/1000 Mbit/s

a. Only for twisted pair connections.

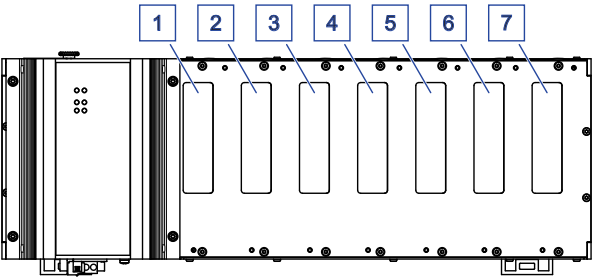
Slots	MSP30/32-2404...	MSP40/42-0028...
	1 10 <sup>a</sup> /100/1000 Mbit/s	1000/2500 Mbit/s
	2 10 <sup>a</sup> /100 Mbit/s	10 <sup>a</sup> /100/1000 Mbit/s
	3 10 <sup>a</sup> /100 Mbit/s	10 <sup>a</sup> /100/1000 Mbit/s
	4 10 <sup>a</sup> /100 Mbit/s	10 <sup>a</sup> /100/1000 Mbit/s
	5 10 <sup>a</sup> /100 Mbit/s	10 <sup>a</sup> /100/1000 Mbit/s
	6 10 <sup>a</sup> /100 Mbit/s	10 <sup>a</sup> /100/1000 Mbit/s
	7 10 <sup>a</sup> /100 Mbit/s	10 <sup>a</sup> /100/1000 Mbit/s

a. Only for twisted pair connections.

## **1.5 Power supply**

### **1.5.1 Supply voltage with the characteristic value C**

For the redundant supply of the device, two 4-pin terminal blocks are available.

See [“Supply voltage with the characteristic value C” on page 54.](#)

### **1.5.2 Supply voltage with the characteristic value P**

For the redundant supply of the device, two 4-pin terminal blocks are available.

The MSP32 and MSP42 device variants support Power over Ethernet (PoE) or Power over Ethernet Plus (PoE+).

See [“Supply voltage with the characteristic value P” on page 55.](#)

## **1.6 SFP Transceiver**

SFP stands for Small Form-factor Pluggable and is also referred to as mini-GBIC (GigaBit Interface Converter).

SFP transceivers allow you to use optical interfaces on your device (Fast Ethernet and Gigabit Ethernet SFP transceivers).

See [“Installing an SFP transceiver \(optional\)” on page 61.](#)

See [“Accessories” on page 89.](#)

## **1.7 Ethernet ports**

You have the option to connect terminal devices or other segments to the ports of the media modules via twisted-pair cables or F/O cables.

Connect the ports of the media modules plugged into the basic device as required in order to set up your industrial Ethernet or expand your existing network.

## ■ 10/100/1000 Mbit/s twisted pair port

This port is an RJ45 socket.

The 10/100/1000 Mbit/s twisted pair port allows you to connect network components according to the IEEE 802.3 10BASE-T/100BASE-TX/1000BASE-T standard.

This port supports:

- ▶ 10 Mbit/s half-duplex mode, 10 Mbit/s full duplex mode
- ▶ 100 Mbit/s half-duplex mode, 100 Mbit/s full duplex mode
- ▶ 1000 Mbit/s full duplex
- ▶ Autocrossing (if autonegotiation is activated)
- ▶ Autonegotiation
- ▶ Autopolarity
- ▶ In addition, the MSM42 media module allows you to use Power over Ethernet (PoE) according to IEEE 802.3af and Power over Ethernet Plus (PoE+) according to IEEE 802.3at.

The PoE power is supplied via the wire pairs transmitting the signal (phantom voltage).

Delivery state: Autonegotiation activated

The port casing is electrically connected to the front panel.

The pin assignment corresponds to MDI-X.

Figure	Pin	MSM40 Function	MSM42 PoE voltage feed
	1	BI_DB+	Minus terminal of the supply voltage
	2	BI_DB-	Minus terminal of the supply voltage
	3	BI_DA+	Plus terminal of the supply voltage
	4	BI_DD+	—
	5	BI_DD-	—
	6	BI_DA-	Plus terminal of the supply voltage
	7	BI_DC+	—
	8	BI_DC-	—

Table 28: Pin assignment 10/100/1000 Mbit/s TP interface in MDI-X mode, RJ45 socket

## ■ 10/100 Mbit/s twisted pair port

This port is designed as an 4-pin M12 socket.

The 10/100 Mbit/s twisted pair port allows you to connect network components according to the IEEE 802.3 10BASE-T/100BASE-TX standard.

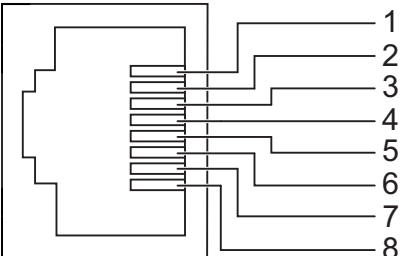
This port supports:

- ▶ 10 Mbit/s half-duplex mode, 10 Mbit/s full duplex mode
- ▶ 100 Mbit/s half-duplex mode, 100 Mbit/s full duplex mode
- ▶ Autocrossing (if autonegotiation is activated)
- ▶ Autonegotiation



- ▶ Autopolarity
- ▶ In addition, the MSM22 media module allows you to use Power over Ethernet (PoE) according to IEEE 802.3af and Power over Ethernet Plus (PoE+) according to IEEE 802.3at.  
The PoE power is supplied via the wire pairs transmitting the signal (phantom voltage).  
Delivery state: Autonegotiation activated

Figure	Pin	MSM20 Function	MSM22 PoE (PSE)
	1	TD+    Transmission path	+
	2	RD+    Receive path	-
	3	TD-    Transmission path	+
	4	RD-    Receive path	-
Housing: shield			

Table 29: Pin assignment of 10/100 Mbit/s twisted pair port, M12 socket

### ■ 1/2.5 Gbit/s F/O port

This port is an SFP slot.

The port allows you to connect network components according to the IEEE 802.3 1000BASE-SX/1000BASE-LX standard.

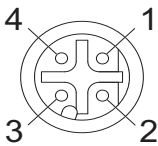
The port allows you to connect network components according to IEEE P802.3bz 2.5 Gbit/s.

This port supports:

Full duplex mode

Delivery state:

1/2.5 Gbit/s full duplex when using a Gigabit Ethernet SFP transceiver

### ■ 100/1000 Mbit/s F/O port

This port is an SFP slot.

The 100/1000 Mbit/s F/O port allows you to connect network components according to the IEEE 802.3 100BASE-FX/1000BASE-SX/1000BASE-LX standard.

- ▶ 100 Mbit/s half-duplex mode, 100 Mbit/s full duplex mode

- ▶ 1000 Mbit/s full duplex

State on delivery:

- ▶ 100 Mbit/s full duplex when using a Fast Ethernet SFP transceiver

- ▶ 1000 Mbit/s full duplex when using a Gigabit Ethernet SFP transceiver

### ■ 100 Mbit/s F/O port

This port is a DSC socket or a DST socket.

The 100 Mbit/s F/O port allows you to connect network components according to the IEEE 802.3 100BASE-FX standard.

- ▶ 100 Mbit/s half-duplex mode, 100 Mbit/s full duplex mode

State on delivery:

- ▶ 100 Mbit/s, full duplex

## 1.8 Display elements

After the supply voltage is set up, the software starts and initializes itself. Afterwards, the device performs a self-test. During this process, various LEDs light up.

### 1.8.1 Device state

These LEDs provide information about conditions which affect the operation of the whole device.

Status   Power

RM   ACA

I1   I2

LED	Display	Color	Activity	Meaning
Power	Supply voltage	—	none	Supply voltage is too low
		yellow	Lights up	Device variants with redundant power supply: Supply voltage 1 <b>or</b> 2 is on
			flashes 4 times a period	Software update is running. Maintain the power supply.
		green	Lights up	Device variants with redundant power supply: Supply voltage 1 <b>and</b> 2 is on. Device variants with single power supply: Supply voltage is on
Status	Device Status	—	none	Device is starting and/or is not ready for operation
		green	Lights up	Device is ready for operation. Characteristics can be configured
		red	Lights up	Device is ready for operation. Device has detected at least one error in the monitoring results
			Flashes 1 time a period	The boot parameters used when the device has been started differ from the boot parameters saved. Start the device again.
			flashes 4 times a period	Device has detected a multiple IP address
RM	Ring Manager	—	none	No redundancy configured
		green	Lights up	Redundancy exists
			Flashes 1 time a period	Device is reporting an incorrect configuration of the RM function
ACA	Storage medium ACA	—	none	ACA storage medium not connected
		green	Lights up	ACA storage medium connected
			Flashes 3 times a period	Device writes to/reads from the storage medium
		yellow	Lights up	ACA storage medium inoperative

## 1.8.2 Digital input

LED	Display	Color	Activity	Meaning
I1	LED display element for input	—	none	Low level input voltage
		green	Lights up	High level input voltage
I2	LED display element for input	—	none	Low level input voltage
		green	Lights up	High level input voltage

## 1.8.3 MSM20 media modules

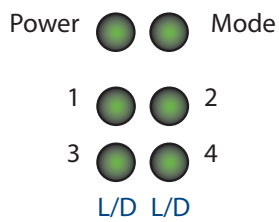

LED	Display	Color	Activity	Meaning
Power	Supply voltage	—	none	Media module is inoperative
		green	Lights up	Voltage supply to the media module is on
Mode	Device Status	—	none	The media module is connected to the Fast Ethernet slot.
		green	Lights up	The media module is connected to the Gigabit Ethernet slot.
L/D	Link status	—	none	Device detects an invalid or missing link
		green	Lights up	Device detects a valid link
			Flashes 1 time a period	Port is switched to stand-by
			Flashes 3 times a period	Port is switched off
		yellow	Lights up	Device detects a <b>non</b> -supported SFP transceiver or a <b>non</b> -supported data rate
			Flashing	Device is transmitting and/or receiving data
			Flashes 1 time a period	Device detects at least one unauthorized MAC address (Port Security Violation)

Table 30: Device status and port status for MSM20 media modules

## 1.8.4 MSM40 media modules

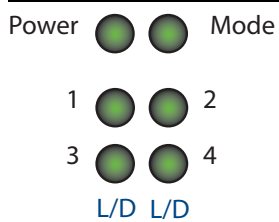

LED	Display	Color	Activity	Meaning
Power	Supply voltage	—	none	Media module is inoperative
		green	Lights up	Voltage supply to the media module is on
Mode	Device Status	—	none	The media module is connected to the Fast Ethernet slot.
		green	Lights up	The media module is connected to the Gigabit Ethernet slot.
L/D	Link status	—	none	Device detects an invalid or missing link
		green	Lights up	Device detects a valid link
			Flashes 1 time a period	Port is switched to stand-by
			Flashes 3 times a period	Port is switched off
		yellow	Lights up	Device detects a <b>non</b> -supported SFP transceiver or a <b>non</b> -supported data rate
			Flashing	Device is transmitting and/or receiving data
			Flashes 1 time a period	Device detects at least one unauthorized MAC address (Port Security Violation)

Table 31: Device status and port status for MSM40 media modules

## 1.8.5 MSM22, MSM42 and MSM46 media modules

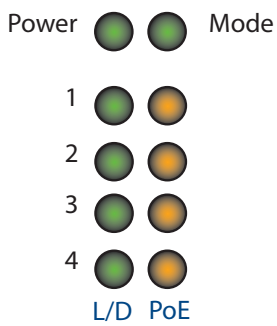

LED	Display	Color	Activity	Meaning
Power	Supply voltage	—	none	Media module is inoperative
		green	Lights up	Voltage supply to the media module is on Voltage supply to the PoE port is on
		yellow	Lights up	PoE voltage is missing or is too low
Mode	Device Status	—	none	The media module is connected to the Fast Ethernet slot.
		green	Lights up	The media module is connected to the Gigabit Ethernet slot.
L/D	Link status	—	none	Device detects an invalid or missing link
		green	Lights up	Device detects a valid link
			Flashes 1 time a period	Port is switched to stand-by
			Flashes 3 times a period	Port is switched off
		yellow	Lights up	Device detects a <b>non</b> -supported SFP transceiver or a <b>non</b> -supported data rate
			Flashing	Device is transmitting and/or receiving data
PoE	PoE status	green	Lights up	Power device is supplied with PoE voltage
			Flashes 3 times a period	PoE administrator status deactivated
		yellow	Flashes 1 time a period	Output budget has been exceeded Device has detected a connected powered device

Table 32: Device status and port status for MSM22, MSM42 and MSM46 media modules

## 1.8.6 MSM50 media modules

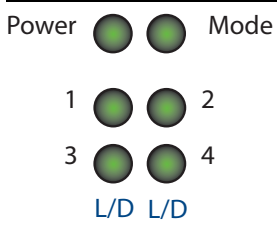

LED	Display	Color	Activity	Meaning
Power	Supply voltage	—	none	Media module is inoperative
		green	Lights up	Voltage supply to the media module is on
Mode	Device Status	green	Lights up	The media module is connected to the Gigabit Ethernet slot.
L/D	Link status	—	none	Device detects an invalid or missing link
		green	Lights up	Device detects a valid link
			Flashes 1 time a period	Port is switched to stand-by
			Flashes 3 times a period	Port is switched off
		yellow	Lights up	Device detects a <b>non</b> -supported SFP transceiver or a <b>non</b> -supported data rate
			Flashing	Device is transmitting and/or receiving data
	Flashes 1 time a period	Device detects at least one unauthorized MAC address (Port Security Violation)		

Table 33: Device status and port status for MSM50 media modules

## 1.8.7 MSM24 I/O module

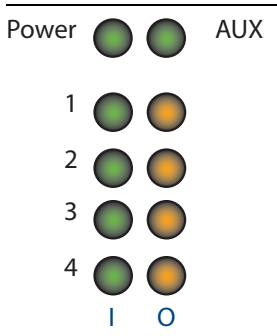

LED	Display	Color	Activity	Meaning
Power	Supply voltage	—	none	The I/O module is not operating.
		green	Lights up	The voltage supply to the I/O module is on.
AUX	Device Status	—	none	The auxiliary supply voltage is not on <b>or</b> is too low.
		green	Lights up	The auxiliary supply voltage is on.

Table 34: Device status and I/O status for MSM24 I/O module

LED	Display	Color	Activity	Meaning
Input (I)	Digital input	—	none	Input voltage: low level
		green	Lights up	Input voltage: high level
Output (O)	Digital output	—	none	The output relay is deactivated (idle status).
		green	Lights up	The output relay is activated.
		yellow	Flashes 3 times a period	The synchronization of the digital output with the assigned input has failed.

*Table 34: Device status and I/O status for MSM24 I/O module*

## 1.9 Management interfaces

### 1.9.1 V.24 interface (external management)

A serial interface is provided on the RJ45 socket (V.24 interface) for the local connection of an external management station (VT100 terminal or PC with corresponding terminal emulation). This gives you the option to set up a connection to the Command Line Interface (CLI) and to the system monitor.

VT100 terminal settings	
Speed	9600 Baud
Data	8 bit
Stopbit	1 bit
Handshake	off
Parity	none

The socket housing is electrically connected to the front panel of the device. The V.24 interface is electrically insulated from the supply voltage.

Figure	Pin assignment	Function
	1	—
	2	—
	3	TX
	4	GND
	5	—
	6	RX
	7	—
	8	—

Table 35: Pin assignment of the V.24 interface

**Note:** For information about the position on the device see [“View from below” on page 28](#).

The Terminal cable is available as an accessory.

See [“Accessories” on page 89](#).

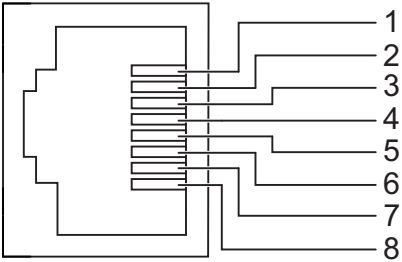
### 1.9.2 SD card interface (optional)

Applies only to device variants featuring customer-specific version with the characteristic value HH.

The SD card interface allows you to connect the AutoConfiguration Adapter ACA31 storage medium. This is used for saving/loading the configuration data and diagnostic information, and for loading the software.

**Note:** For information about the position on the device see [“View from above” on page 29](#).



On the front of the device there is an LED display that informs you about the status of the interface.

### 1.9.3 USB interface

**Note:** Applies to approval DNV GL:

Note that the USB interface of the MSP30/32/40/42 is for service purposes only. Do not connect any USB adapter during normal operation.

The USB interface allows you to connect the AutoConfiguration Adapter ACA21/22 storage medium. This is used for saving/loading the configuration data and diagnostic information, and for loading the software.

The device supports the ACA21/ACA22 starting with the software version 3.0.

The USB interface has the following properties:

- ▶ Supplies current of max. 500 mA
- ▶ Voltage not potential-separated
- ▶ Connectors: type A
- ▶ Supports the USB master mode
- ▶ Supports USB 2.0

Figure	Pin	Operation
	1	VCC (VBus)
	2	- Data
	3	+ Data
	4	Ground (GND)

Table 36: Pin assignment of the USB interface

**Note:** For information about the position on the device see [“View from below” on page 28](#).

## 1.10 Input/output interfaces

### 1.10.1 Signal contact

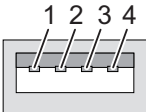
Figure	Pin	Function

Connection for the power supply including signal contact P1

Table 37: Pin assignment of the 4-pin terminal block for the connection of the signal contact

Figure	Pin	Function
	1	Plus terminal of the supply voltage
	2	Minus terminal of the supply voltage
	3	<b>FAULT</b>
	4	<b>FAULT</b>
Connection for the power supply including signal contact P2		
	1	Plus terminal of the supply voltage
	2	Minus terminal of the supply voltage
	3	<b>FAULT</b>
	4	<b>FAULT</b>

Table 37: Pin assignment of the 4-pin terminal block for the connection of the signal contact

The signal contact is a potential-free relay contact. The signal contact is open when the device is not connected to a power supply.

The signal contact allows you to control external devices or monitor device functions.

In the configuration, you specify how the device uses the signal contact. You find detailed information regarding possible applications and configuration of the signal contact in the software user documentation on the Hirschmann product pages ([www.hirschmann.com](http://www.hirschmann.com)).

**Note:** For information about the position on the device see “View from below” on page 28.

### 1.10.2 Digital input

Figure	Pin	Signal, terminal	Function	
	Input 1 (I1)	1	IN-1	Signal input, channel 1
		2	IN-1-GND	Reference potential, channel 1
	Input 2 (I2)	3	IN-2	Signal input, channel 2
		4	IN-2-GND	Reference potential, channel 2

Table 38: Pin assignment of the input interface

**Note:** For information about the position on the device see “View from below” on page 28.

## 2 Installation

The devices have been developed for practical application in a harsh industrial environment.

Hirschmann supplies the device ready for operation.

Perform the following steps to install and configure the device:

- ▶ [Checking the package contents](#)
- ▶ [Installing the SD card \(optional\)](#)
- ▶ [Installing and grounding the device](#)
- ▶ [Connecting the terminal blocks](#)
- ▶ [Installing terminal blocks, switching on the supply voltage](#)
- ▶ [Installing media modules](#)
- ▶ [Connecting an I/O module](#)
- ▶ [Installing an SFP transceiver \(optional\)](#)
- ▶ [Connecting data cables](#)

### 2.1 Checking the package contents

- Check whether the package includes all items named in the section [“Scope of delivery” on page 89](#).
- Check the individual parts for transport damage.

### 2.2 Installing the SD card (optional)

Applies only to device variants featuring customer-specific version with the characteristic value HH.

**Note:** Only use the AutoConfiguration Adapter ACA31 storage medium. See [“Accessories” on page 89](#).

- Deactivate the write protection on the SD card by pushing the write-protect lock towards the middle of the card.
- Push the SD card into the slot with the beveled corner facing upwards.
- Tighten the thumb screw hand-tight to fix the SD card.

**Note:** For information about the position on the device see [“View from above” on page 29](#).

## 2.3 Installing and grounding the device

### **WARNING**

#### **FIRE HAZARD**

Install the device in a fire enclosure according to EN 60950-1.

**Failure to follow these instructions can result in death, serious injury, or equipment damage.**

### **CAUTION**

#### **BURNING HAZARD**

The surfaces of the device casing may become hot. Avoid touching the device while it is operating.

If ambient temperatures are  $\geq 113$  °F ( $\geq 45$  °C), exclusively install the device in “restricted access locations” according to EN 60950-1.

**Failure to follow these instructions can result in injury or equipment damage.**

- When you are selecting the installation location, make sure you observe the climatic threshold values specified in the technical data. Prevent heat from the surroundings from affecting the device.
- Verify that there is at least 4 in (10 cm) of space above and below the device.
- Verify that there is at least 0.8 in (2 cm) of space on the right and left sides of the device.

### **2.3.1 Installing the device onto the DIN rail**

The device variants featuring customer-specific version with the characteristic value HH are suitable for mounting on a DIN rail.

Proceed as follows:

- Install the device on a horizontally mounted 1.38 inch (35 mm) DIN rail in accordance with DIN EN 60715.
- Insert the upper snap-in guide of the device into the DIN rail and press the device down against the DIN rail until it snaps into place.

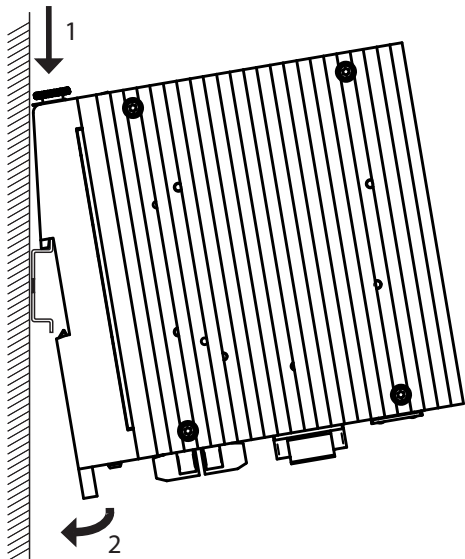

Figure 1: Mounting on the DIN rail

### 2.3.2 Mounting on a flat surface

The device variants featuring the customer-specific version with characteristic value HX are suitable for installation on a flat surface. Proceed as follows:

- You will find the drilling dimensions for mounting the device in the chapter [“Dimension drawings” on page 77](#).
- Mount the device with cylinder head screws M4 × 30 to the flat surface.

### 2.3.3 Grounding the device

## ⚠ WARNING

### ELECTRIC SHOCK

Ground the device before connecting any other cables.

**Failure to follow these instructions can result in death, serious injury, or equipment damage.**

The device is grounded via the separate ground screw on the bottom right of the bottom of the device.

Both power supply unit variants have a function ground.

- Ground the device via the ground screw.  
You find the prescribed tightening torque in chapter: [“General technical data” on page 72](#)

**Note:** For information about the position on the device see [“View from below” on page 28](#).

## 2.4 Connecting the terminal blocks

### **WARNING**

#### **ELECTRIC SHOCK**

Never insert pointed objects (narrow screwdrivers, wires, etc.)

- into the device or
- into the connection terminals for electric conductors or
- into the connection terminals for the signal conductors

Do not touch the connection terminals.

**Failure to follow these instructions can result in death, serious injury, or equipment damage.**

**Note:** The supply voltage is connected to the device casing through protective elements exclusively.

### 2.4.1 Supply voltage with the characteristic value C

You have the option of supplying the supply voltage redundantly, without load distribution.

Both supply voltage inputs are uncoupled.

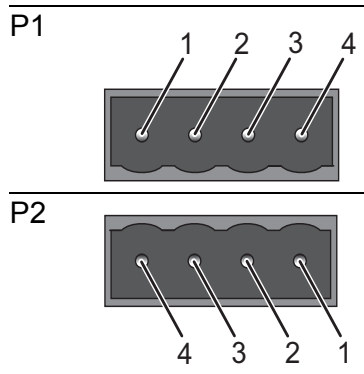

Table 39: Supply voltage with the characteristic value C: two 4-pin terminal blocks

Type of the voltages that can be connected	Specification of the supply voltage	Pin	Terminal block	Pin assignment
DC voltage	Nominal voltage range 24 V DC ... 48 V DC	1	P1	Plus terminal of the supply voltage
		1	P2	
	Voltage range incl. maximum tolerances 18 V DC ... 60 V DC	2	P1	Minus terminal of the supply voltage
		2	P2	

Table 40: Supply voltage with the characteristic value C: type and specification of the supply voltage, connections

- Remove the power connector from the device.
- Connect the protective conductor with the clamp.
- Connect the lines for the supply voltage to the + and - terminals.

With non-redundant supply of the mains voltage, the device reports a power failure. You can avoid this message by changing the configuration in the management, or, with power supply units of the same type, by feeding the supply voltage in through both inputs.

## 2.4.2 Supply voltage with the characteristic value P

You have the option of supplying the supply voltage redundantly, without load distribution.

Both supply voltage inputs are uncoupled.

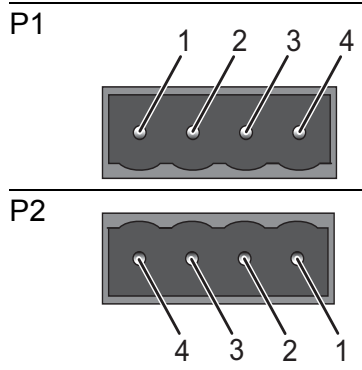

Table 41: Supply voltage with the characteristic value P: two 4-pin terminal blocks

Type of the voltages that can be connected	Specification of the supply voltage	Pin	Terminal block	Pin assignment
Device variants with PoE: DC voltage	Rated voltage 48 V DC	1	P1	Plus terminal of the supply voltage
		1	P2	
	Voltage range incl. maximum tolerances 45 V DC ... 57 V DC	2	P1	Minus terminal of the supply voltage
		2	P2	
Device variants with PoE Plus: DC voltage	Rated voltage 54 V DC	1	P1	Plus terminal of the supply voltage
		1	P2	
	Voltage range incl. maximum tolerances 51 V DC ... 57 V DC	2	P1	Minus terminal of the supply voltage
		2	P2	

Table 42: Supply voltage with the characteristic value P: type and specification of the supply voltage, connections

- Remove the power connector from the device.
- Connect the protective conductor with the clamp.
- Connect the lines for the supply voltage to the + and - terminals.

### 2.4.3 Signal contact

For every signal contact to be connected, make sure the following requirements are met:

- ▶ The electrical wires are voltage-free.
- ▶ The connected voltage is limited by a current limitation device or a fuse. Observe the electrical threshold values for the signal contact.  
[See “General technical data” on page 72.](#)
- Connect the signal contact lines with the terminal block connections.

## 2.5 Connecting the ferrite

Applies only to the MSP30/32-0804 device variants with approvals for marine applications.

To adhere to EMC conformity, you connect the ferrite supplied to the voltage input via the power supply cable.

- Insert the power supply cable through the ferrite 3 times.
- Position the ferrite as close as possible to the voltage input (max. distance 19.7 in (50 cm)).
- Lock the ferrite.

**Note:** To open the ferrite use the key supplied.



*Figure 2: Connecting the ferrite to the voltage supply line*



## 2.6 Installing terminal blocks, switching on the supply voltage

### **WARNING**

#### **ELECTRIC SHOCK**

Connect only a supply voltage that corresponds to the type plate of your device.

**Failure to follow these instructions can result in death, serious injury, or equipment damage.**

- Use screws to secure the connectors to the device.  
You find the prescribed tightening torque in chapter:  
[“General technical data” on page 72](#)
- Enable the supply voltage.

**Note:** Enable the supply voltage for the device only when the following requirements are fulfilled:

- the device casing is closed
- the terminal blocks are wired correctly
- the terminal blocks for the supply voltage are connected

## 2.7 Installing media modules

Hirschmann supplies the media modules ready for operation. You have the option to mount the media modules while the device is operating.

## 2.7.1 Device variants featuring customer-specific version with the characteristic value HH

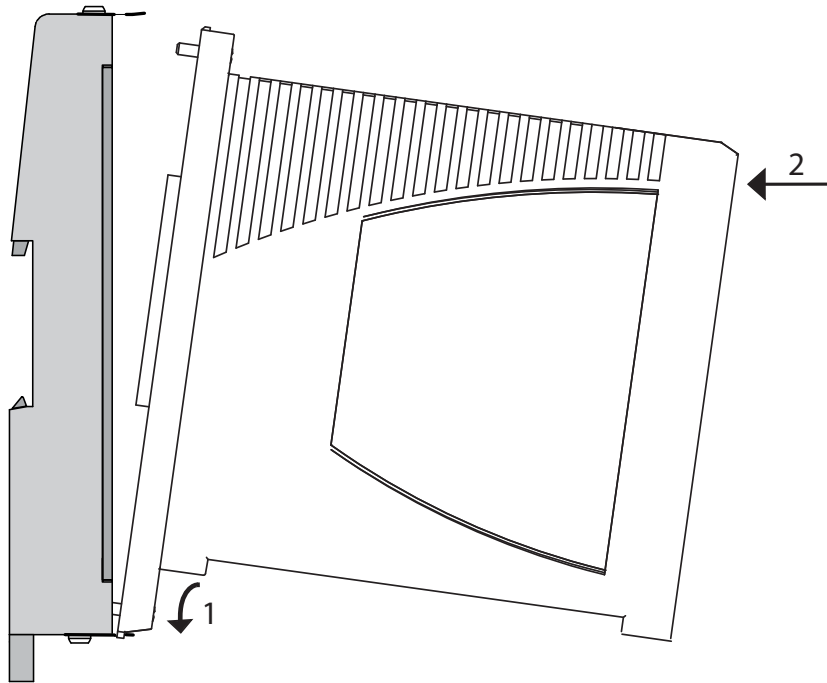

Proceed as follows:

- Remove the protective cap from the slot for the media module on the device.
- Insert the latch on the bottom of the media module into the opening in the lower positioning bar of the basic device.
- Press the media module against the basic device until the latch on the top of the media module snaps into the upper female multipoint connector.
- Fasten the media modules with 2 screws in the backplane.

You find the prescribed tightening torque in chapter:

[“General technical data” on page 72](#)

**Note:** On the basic device MSP40/42, the media module slot 1 is coded differently from the other slots. Only MSM50 media modules can be installed on this media module slot.

## 2.7.2 Device variants featuring customer-specific version with the characteristic value HX

Proceed as follows:

- Remove the protective cap from the slot for the media module on the device.
- Mount the media module on the slot.
- Fasten the device with the hardware elements provided by screwing to the basic device.

You find the prescribed tightening torque in chapter:

[“General technical data” on page 72](#)

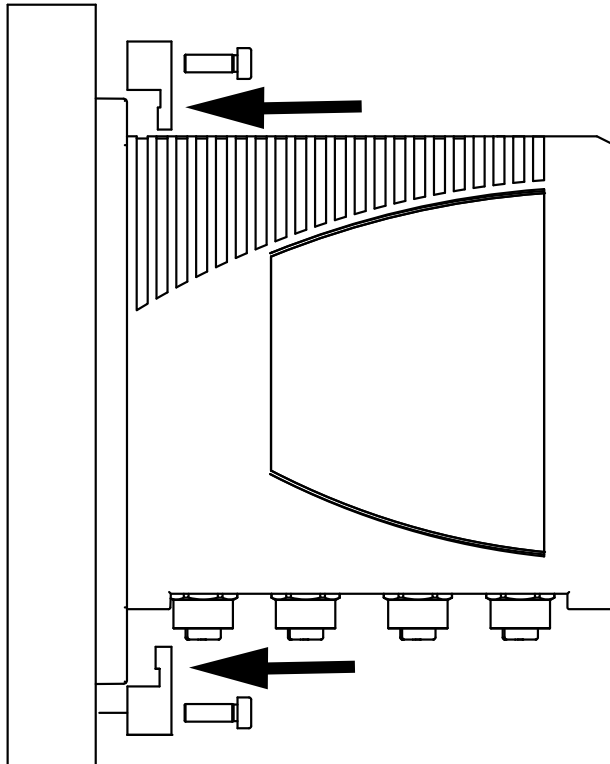

**Note:** Media modules with characteristic value HX are exclusively designed for installation on MSP basic devices with characteristic value HX.

## 2.7.3 Connecting the external PoE supply voltage of media module MSM46

- Remove the power connector from the device.
- Connect the protective conductor with the clamp.
- Connect the PoE voltage to the 3-pin terminal block.

You find the prescribed tightening torque in chapter:

[“General technical data” on page 72](#)

The supply voltage inputs are designed for operation with safety extra-low voltage. Connect only SELV circuits with voltage restrictions in line with IEC/EN 60950-1 to the supply voltage connections.

Make sure that the connected supply voltage complies the requirements of IEEE 802.3af or IEEE 802.3at:

- ▶ For the use of type-1-powered devices (PoE):  
Rated voltage: 48 V DC  
Max. voltage range: 45 V DC ... 57 V DC
- ▶ For the use of Type 2 Powered Devices (PoE+):  
Rated voltage: 54 V DC  
Max. voltage range: 51 V DC ... 57 V DC
- ▶ Max. PoE power: 62 W

## 2.8 Connecting an I/O module

### 2.8.1 Connecting actuators and sensors

To connect an external device, proceed as follows:

- Release the terminal blocks for the digital inputs and digital outputs from the bottom of the I/O module.
- Connect the digital outputs and digital inputs of the MSM24 I/O module as required.

[See “MSM24 I/O module” on page 35.](#)

You can select from 3 different connection constellations:

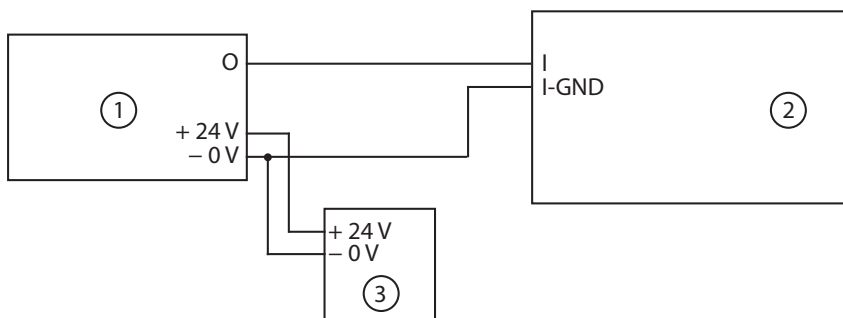

*Figure 3: Connection of a sensor with separate voltage supply*  
1 - Sensor  
2 - MSM24 module  
3 - Separate voltage supply for sensor

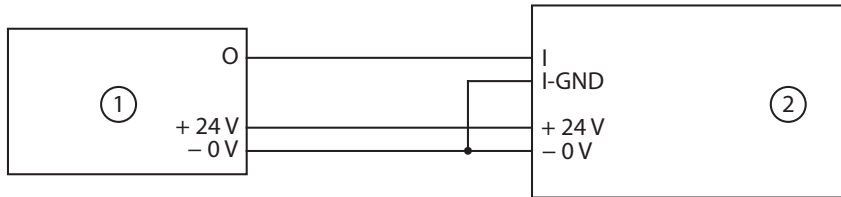

*Figure 4: Connection of a sensor with auxiliary voltage supply*  
 1 - Sensor  
 2 - MSM24 module

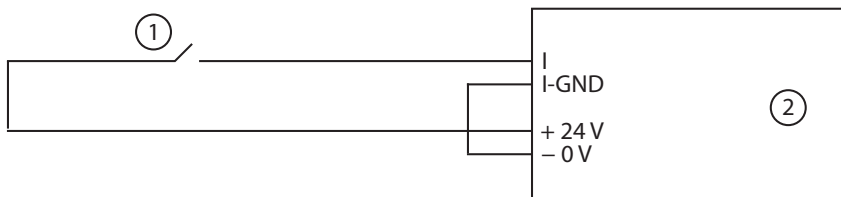

*Figure 5: Circuit via auxiliary voltage supply*  
 1 - Switch (2-wire sensor)  
 2 - MSM24 module

- If required, connect the 24 V DC auxiliary voltage ([see table 23](#)).

**Note:** Make sure not to exceed the maximum load ([see on page 72](#) “[General technical data](#)”).

- Push the terminal blocks back onto the I/O module. Tighten the screws on the terminal blocks.  
 You find the prescribed tightening torque in chapter:  
[“General technical data” on page 72](#)
- You start the operation of the I/O module by connecting the supply voltage via the terminal block or the terminal blocks to the basic device MSP30/32/40/42.

## 2.9 Installing an SFP transceiver (optional)

Prerequisites:

Exclusively use Hirschmann SFP transceivers.

[See “Accessories” on page 89.](#)

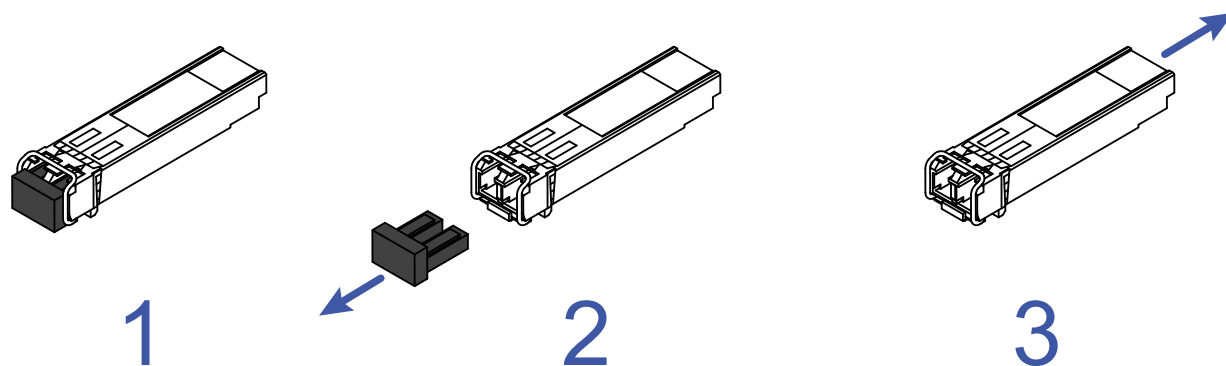

Figure 6: Installing SFP transceivers: Installation sequence

Proceed as follows:

- Take the SFP transceiver out of the transport packaging (1).
- Remove the protection cap from the SFP transceiver (2).
- Push the SFP transceiver with the lock closed into the slot until it latches in (3).

## 2.10 Connecting data cables

Note the following general recommendations for data cable connections in environments with high electrical interference levels:

- Keep the length of the data cables as short as possible.
- Use optical data cables for the data transmission between the buildings.
- When using copper cables, provide a sufficient separation between the power supply cables and the data cables. Ideally, install the cables in separate cable channels.
- Verify that power supply cables and data cables do not run parallel over longer distances. If reducing the inductive coupling is necessary, verify that the power supply cables and data cables cross at a 90° angle.
- Use SF/UTP cables as per ISO/IEC 11801:2002.

**Note:** Verify that you connect only optical ports with the same optical transmission properties with each other.

**Note:** For media modules with M12 sockets: Screw all data cables to the media modules.

You find the prescribed tightening torque in chapter:

[“General technical data” on page 72](#)

Also note the plug manufacturer's specifications.

### **2.10.1 10/100/1000 Mbit/s twisted pair port**

Further information:

[See “10/100/1000 Mbit/s twisted pair port” on page 40.](#)

- Connect the data cables according to your requirements.

### **2.10.2 10/100 Mbit/s twisted pair port**

Further information:

[See “10/100 Mbit/s twisted pair port” on page 40.](#)

- Connect the data cables according to your requirements.

### **2.10.3 1/2.5 Gbit/s F/O port**

Further information:

[See “1/2.5 Gbit/s F/O port” on page 41.](#)

- Connect the data cables according to your requirements.

### **2.10.4 100/1000 Mbit/s F/O port**

Further information:

[See “100/1000 Mbit/s F/O port” on page 41.](#)

- Connect the data cables according to your requirements.

### **2.10.5 100 Mbit/s F/O port**

Further information:

[See “100 Mbit/s F/O port” on page 41.](#)

- Connect the data cables according to your requirements.

### 3 Basic Settings

The IP parameters must be entered when the device is installed for the first time. The device provides the following options for configuring IP addresses:

- ▶ AutoConfiguration Adapter
- ▶ Entry via the HiDiscovery protocol in the applications HiDiscovery or Industrial HiVision application
- ▶ Input via the V.24 interface
- ▶ Configuration via BOOTP
- ▶ Configuration via DHCP (Option 82)

You will find more information in the “Basic Configuration User Manual”.

#### ■ Default settings

- ▶ Ethernet ports: link status is not evaluated (signal contact)
- ▶ IP address: The device looks for the IP address using DHCP
- ▶ Optical ports: Full duplex  
TP ports: Autonegotiation
- ▶ Management password:  
user, password: public (read only)  
admin, password: private (read/write)
- ▶ Rapid Spanning Tree Protocol: activated
- ▶ V.24 data rate: 9600 Baud



## 4 Monitoring the ambient air temperature

Operate the device below the specified maximum ambient air temperature exclusively.

See [“General technical data” on page 72](#).

The ambient air temperature is the temperature of the air at a distance of 2 in (5 cm) from the device. It depends on the installation conditions of the device, for example the distance from other devices or other objects, and the output of neighboring devices.

The temperature displayed in the CLI and the GUI is the internal temperature of the device. It is higher than the ambient air temperature. The maximum internal temperature of the device named in the technical data is a guideline that indicates to you that the maximum ambient air temperature has possibly been exceeded.

## 5 Upgrading Software

The upgrade options for MSP30/32/40/42 and MSM20/22/24/40/42/46/50 device depend on the software level of the device.

See “Device name and product code” on page 20.

**Note:** For software version 04.0 or higher, “HiOS” is available as a common software image for all software levels.

You select only the desired redundancy function during the installation of the image. After finishing the installation and manually restarting the device, the device automatically activates the functions of the software level saved in the product code.

Software version		Software level according to the product code		
		2A	3A (UR)	3A (MR)
Up to HiOS 03.0	Name of the software image	HiOS-2A	HiOS-2A	HiOS-2A
	Range of functions corresponds to	2A	2A	2A
From HiOS 04.0 onward	Name of the software image	HiOS	HiOS	HiOS
	Range of functions corresponds to	2A	3A (UR)	3A (MR)

Table 43: Upgrade options

## 6 Maintenance and service

- ▶ When designing this device, Hirschmann largely avoided using high-wear parts. The parts subject to wear and tear are dimensioned to last longer than the lifetime of the product when it is operated normally. Operate this device according to the specifications.
- ▶ Relays are subject to natural wear. This wear depends on the frequency of the switching operations. Check the resistance of the closed relay contacts and the switching function depending on the frequency of the switching operations.
- ▶ Hirschmann is continually working on improving and developing their software. Check regularly whether there is an updated version of the software that provides you with additional benefits. You find information and software downloads on the Hirschmann product pages on the Internet (<http://www.hirschmann.com>).
- ▶ Depending on the degree of pollution in the operating environment, check at regular intervals that the ventilation slots in the device are not obstructed.
- ▶ Internal fuses are triggered only in the case of a detected error in the device. In case of damage or malfunction of the device, turn off the supply voltage and return the device to the plant for inspection.

**Note:** You find information on settling complaints on the Internet at <http://www.beldensolutions.com/en/Service/Repairs/index.phtml>.

## 7 Disassembly

### 7.1 Removing an SFP transceiver (optional)

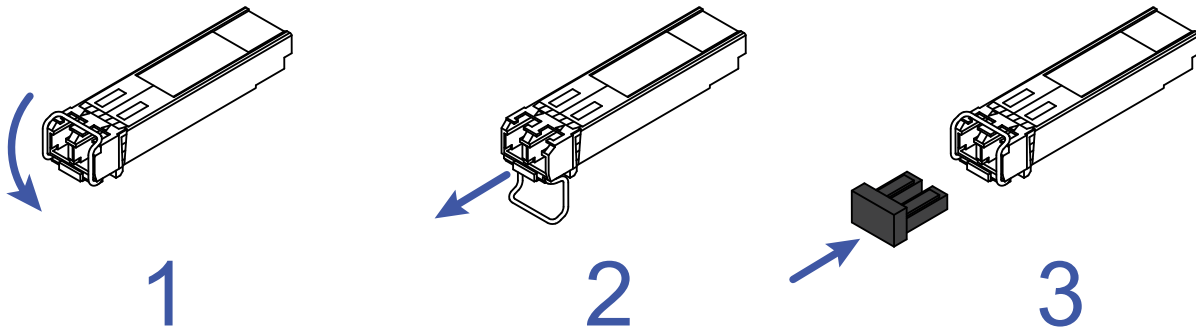

Figure 7: Removing an SFP transceiver: Removal sequence

Proceed as follows:

- Open the locking mechanism of the SFP transceiver (1).
- Pull the SFP transceiver out of the slot via the open locking mechanism (2).
- Close the SFP transceiver with the protection cap (3).

### 7.2 Removing a media module

You have the option to remove the media modules while the device is operating.

## 7.2.1 Device variants featuring customer-specific version with the characteristic value HH

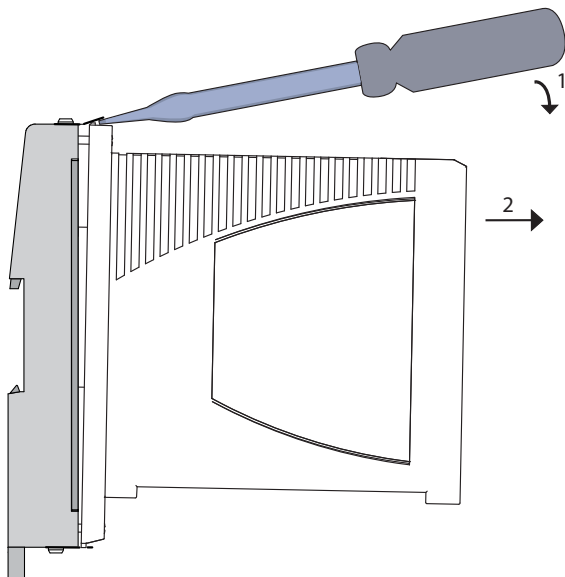

Proceed as follows:

- Disable the supply voltage.
- Additionally with MSM24/MSM46: Disconnect the terminal block.
- Disconnect the data cables.
- Remove the 2 screws.
- Insert a screwdriver between the female multipoint connector and the media module.
- Use the screwdriver to carefully lever the female multipoint connector away from the media module and pull the media module out of the slot.

## 7.2.2 Device variants featuring customer-specific version with the characteristic value HX

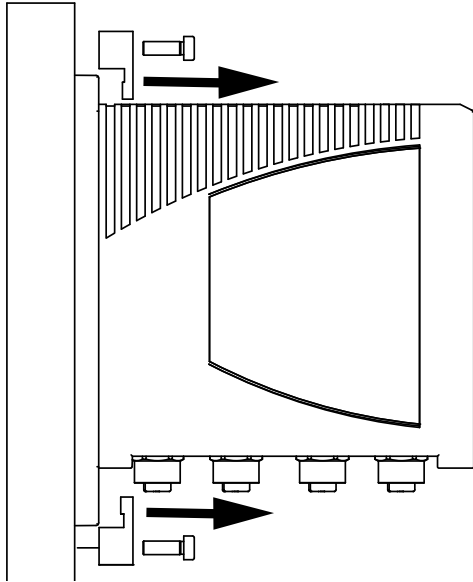

Proceed as follows:

- Disconnect the data cables.
- Remove the screws.
- Pull the media module out of the slot.

## 7.3 Removing the device

### **WARNING**

#### **ELECTRIC SHOCK**

Disconnect the grounding only after disconnecting all other cables.

**Failure to follow these instructions can result in death, serious injury, or equipment damage.**

### 7.3.1 Device variants featuring customer-specific version with the characteristic value HH

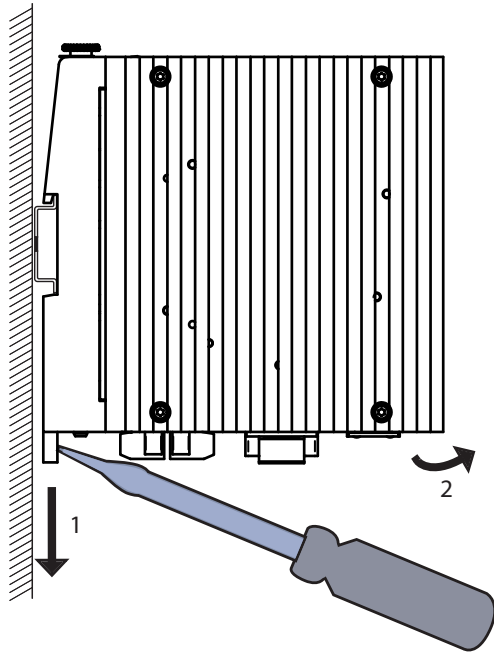

Proceed as follows:

- Disable the supply voltage.
- Disconnect the data cables.
- Disconnect the terminal blocks.
- Disconnect the grounding.
- Insert a screwdriver horizontally below the housing into the locking gate.
- Without tilting the screwdriver, pull the locking gate down and tilt the device upwards.

### 7.3.2 Device variants featuring customer-specific version with the characteristic value HX

Proceed as follows:

- Disable the supply voltage.
- Disconnect the data cables.
- Disconnect the terminal blocks.
- Disconnect the grounding.
- Remove the screws.

## 8 Technical data

### 8.1 General technical data

#### ■ Basic device

Dimensions W × H × D	MSP30/32-0804.....HH...	9.33 in. × 5.83 in. × 5.59 in. (237 mm × 148 mm × 142 mm)		
	MSP40/42-0012.....HH...			
	MSP30/32-1604.....HH...	12.36 in. × 5.83 in. × 5.59 in. (314 mm × 148 mm × 142 mm)		
	MSP40/42-0020.....HH...			
	MSP30/32-2404.....HH...	15.39 in. × 5.83 in. × 5.59 in. (391 mm × 148 mm × 142 mm)		
	MSP40/42-0028.....HH...			
	MSP30-0804.....HX...	10.91 in. × 6.81 in. × 5.51 in. (277 mm × 173 mm × 140 mm)		
	MSP30-1604.....HX...	13.94 in. × 6.81 in. × 5.51 in. (354 mm × 173 mm × 140 mm)		
	MSP30-2404.....HX...	16.97 in. × 6.81 in. × 5.51 in. (431 mm × 173 mm × 140 mm)		
Weight	MSP30-0804.....HH...	4.6 lb (2.1 kg)		
	MSP40-0012.....HH...			
	MSP32-0804.....HH...	4.6 lb (2.2 kg)		
	MSP42-0012.....HH...			
	MSP30-1604.....HH...	5.3 lb (2.4 kg)		
	MSP40-0020.....HH...			
	MSP32-1604.....HH...	5.5 lb (2.5 kg)		
	MSP42-0020.....HH...			
	MSP30-2404.....HH...	5.9 lb (2.65 kg)		
	MSP40-0028.....HH...			
	MSP32-2404.....HH...	6.1 lb (2.75 kg)		
	MSP42-0028.....HH...			
	MSP30-0804.....HX...	6.83 lb (3.1 kg)		
	MSP30-1604.....HX...	7.93 lb (3.6 kg)		
MSP30-2404.....HX...	8.81 lb (4.0 kg)			
Supply voltage with the characteristic value C	Rated voltage range	24 V DC ... 48 V DC		
	Voltage range incl. maximum tolerances	18 V DC ... 60 V DC		
	Connection type	4-pin terminal block max. conductor cross section AWG12 (2.5 mm <sup>2</sup> )		
	Power loss buffer	> 10 ms at 20.4 V DC (only applies to the basic device)		
	Overload current protection at input	Non-replaceable fuse		
	Back-up fuse	Nominal rating:	6.3 A	
		Characteristic:	slow blow	
	Peak inrush current	< 5 A		



Supply voltage with the characteristic value P	Rated voltage	Device variants with PoE: 48 V DC Device variants with PoE Plus: 54 V DC
	Voltage range incl. maximum tolerances	Device variants with PoE: 45 V DC ... 57 V DC
		Device variants with PoE Plus: 51 V DC ... 57 V DC
	Max. PoE power	124 W <sup>a</sup>
	Connection type	4-pin terminal block
		max. conductor cross section AWG12 (2.5 mm <sup>2</sup> )
	Power loss buffer	> 10 ms at 20.4 V DC (only applies to the basic device)
	Overload current protection at input	Non-replaceable fuse
	Back-up fuse	Nominal rating: 6.3 A
		Characteristic: slow blow
Peak inrush current	< 5 A	
Climatic conditions during operation	Ambient air temperature <sup>b</sup> .	Devices with operating temperature characteristic value S (standard): +32 °F ... +140 °F (0 °C ... +60 °C) <sup>c</sup> Devices with operating temperature characteristic value E and T (extended): -40 °F ... +158 °F (-40 °C ... +70 °C) <sup>d</sup> under UL conditions: max. +140 °F (+60 °C)
	Humidity	5 % ... 95 % (non-condensing)
	Air pressure	min. 700 hPa (+9842 ft; +3000 m) max. 1060 hPa (-1312 ft; -400 m)
Climatic conditions during storage	Ambient air temperature <sup>a</sup>	-40 °F ... +185 °F (-40 °C ... +85 °C)
	Humidity	5 % ... 95 % (non-condensing)
	Air pressure	min. 700 hPa (+9842 ft; +3000 m) max. 1060 hPa (-1312 ft; -400 m)
Signal contact "FAULT"	Switching current	max. 1 A, SELV
	Switching voltage	max. 60 V DC or max. 30 V AC, SELV under UL conditions: max. 30 V DC, resistive load
Pollution degree		2
Protection classes	Laser protection	Class 1 in compliance with IEC 60825-1
	Degree of protection	IP20
Tightening torque	4-pin terminal block	4.4 lb-in (0.5 Nm)
	Grounding screw	4.4 lb-in (0.5 Nm)

- a. The MSP basic devices MSP32 and MSP42 support a PoE power budget of 120 W. You cannot expand the PoE power budget of the basic devices with media modules.
- b. Temperature of the ambient air at a distance of 2 in (5 cm) from the device
- c. Hirschmann recommends to use SFP transceivers with "EEC" extension.
- d. Use SFP transceivers with the "EEC" extension only, otherwise the standard temperature range applies.

## ■ Media modules

Dimensions W × H × D	MSM20	1.50 in. × 5.24 in. × 4.65 in. (38 mm × 133 mm × 118 mm)
	MSM22	
	MSM24	
	MSM40	
	MSM42	
	MSM46	
	MSM50	
Weight <sup>a</sup>	MSM20-xxT1T1T1...	0.44 lb (199 g)
	MSM20-xxxxT1T1...	0.45 lb (201 g)
	MSM20-xxxxxxxx...	8.78 oz (249 g)
	MSM20-T5T5T5T5...HH	7.76 oz (220 g)
	MSM20-T5T5T5T5...HX	8.61 oz (244 g)
	MSM22-T5T5T5T5...	7.97 oz (226 g)
	MSM24-IOIOIOIO...	8.85 oz (251 g)
	MSM40-T1T1T1T1...	6.81 oz (193 g)
	MSM40-C1C1C1C1...	7.55 oz (214 g) without SFP transceiver
	MSM42-T1T1T1T1...	7.13 oz (202 g)
	MSM46-T1T1T1T1...	7.94 oz (225 g)
	MSM50-Q6Q6Q6Q6...	6.88 oz (195 g) without SFP transceiver
	Climatic conditions during operation	Ambient air temperature <sup>b</sup>
Humidity		5 % ... 95 % (non-condensing)
Air pressure		min. 700 hPa (+9842 ft; +3000 m) max. 1060 hPa (-1312 ft; -400 m)
Ambient air temperature <sup>b</sup>		-40 °F ... +185 °F (-40 °C ... +85 °C)
Climatic conditions during storage	Humidity	5 % ... 95 % (non-condensing)
	Air pressure	min. 700 hPa (+9842 ft; +3000 m) max. 1060 hPa (-1312 ft; -400 m)
	Pollution degree	2
Protection classes	Laser protection	Class 1 in compliance with IEC 60825-1
	Degree of protection	IP20

Tightening torque	2-pin terminal block	3 lb-in (0.34 Nm)
	3-pin terminal block	4.4 lb-in (0.5 Nm)
	8-pin terminal block	3 lb-in (0.34 Nm)
	12-pin terminal block	3 lb-in (0.34 Nm)
	4-pin M12 connector	5.3 lb-in (0.6 Nm)
	Installation on the backplane with screws Device variants with characteristic value HH/HX	2.65 lb-in (0.3 Nm)
	Installation on the backplane with clamping jaws and M4 screws Device variants with characteristic value HX	17.7 lb-in (2 Nm)

- xx = M2, M4, S2, S4, L2, G2
- Temperature of the ambient air at a distance of 2 in (5 cm) from the device
- Hirschmann recommends to use SFP transceivers with "EEC" extension.
- Use SFP transceivers with the "EEC" extension only, otherwise the standard temperature range applies.

## 8.2 Digital input

Maximum permitted input voltage range	-32 V DC ... +32 V DC
Nominal input voltage	+24 V DC
Input voltage, low level, status "0"	-0.3 V DC ... +5.0 V DC
Input voltage, high level, status "1"	+11 V DC ... +30 V DC
Maximum input current at 24 V input voltage	15 mA
Input characteristic according to IEC 61131-2 (current-consuming)	Type 3
Connection type	8-pin terminal block

**Note:** For the pin assignment see ["Digital input" on page 50](#).

## 8.3 Digital output

Maximum permitted supply voltage	max. 60 V DC or max. 30 V AC, SELV under UL conditions: max. 30 V DC, ohmic load
Maximum current load of relay contacts and terminals	1 A
Maximum switching frequency	1 Hz
Relay type	Changeover
Contact voltage	isolated
Protective circuit of relay contacts	No

Digital output acc. to IEC 61131-2 (current-consuming)	Yes
Connection type	12-pin terminal block

**Note:** For the pin assignment see [table 23 on page 36](#).

## 8.4 24 V DC auxiliary voltage (AUX)

Output voltage range	+24 V DC ... +27 V DC
Maximum output power	3.0 W
Short-circuit protection	yes (electronically)
Under-voltage deactivation	Yes
Connection type	2-pin terminal block

**Note:** For the pin assignment see [table 23 on page 36](#).

## 8.5 External PoE power supply (MSM46)

Rated voltage	Device variants with PoE:	48 V DC
	Device variants with PoE Plus:	54 V DC
Voltage range incl. maximum tolerances	Device variants with PoE:	45 V DC ... 57 V DC
	Device variants with PoE Plus:	51 V DC ... 57 V DC
Max. PoE power		62 W
Connection type		3-pin terminal block
Back-up fuse	Nominal rating:	6.3 A
	Characteristic:	slow blow
Peak inrush current		< 5 A

**Note:** For the pin assignment see [“MSM22, MSM42 and MSM46 media modules” on page 45](#).

# 8.6 Dimension drawings

## ■ Basic device

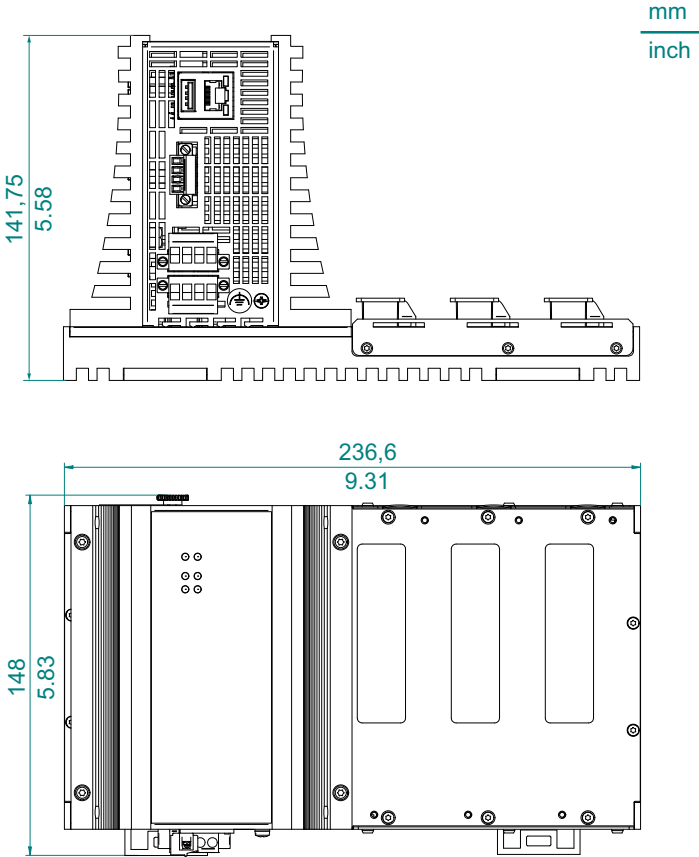

Figure 8: MSP30/32-0804.....HH..., MSP40/42-0012.....HH...

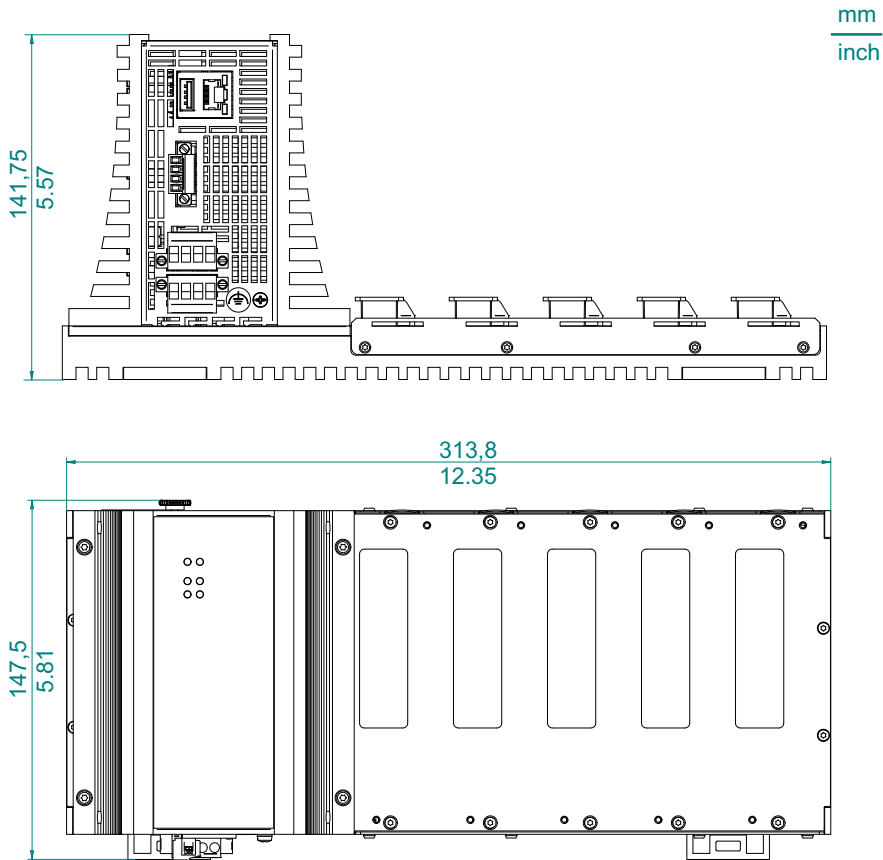

Figure 9: MSP30/32-1604.....HH..., MSP40/42-0020.....HH...

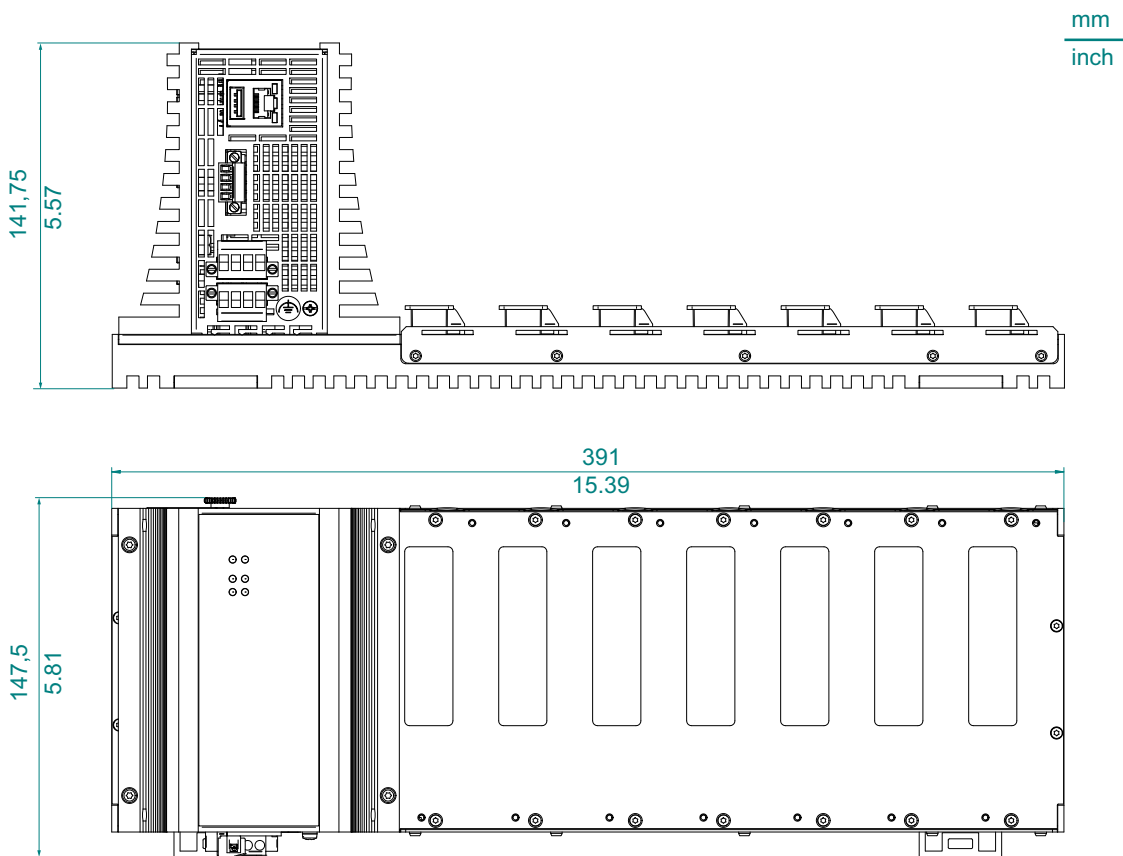

Figure 10: MSP30/32-2404.....HH..., MSP40/42-0028.....HH...

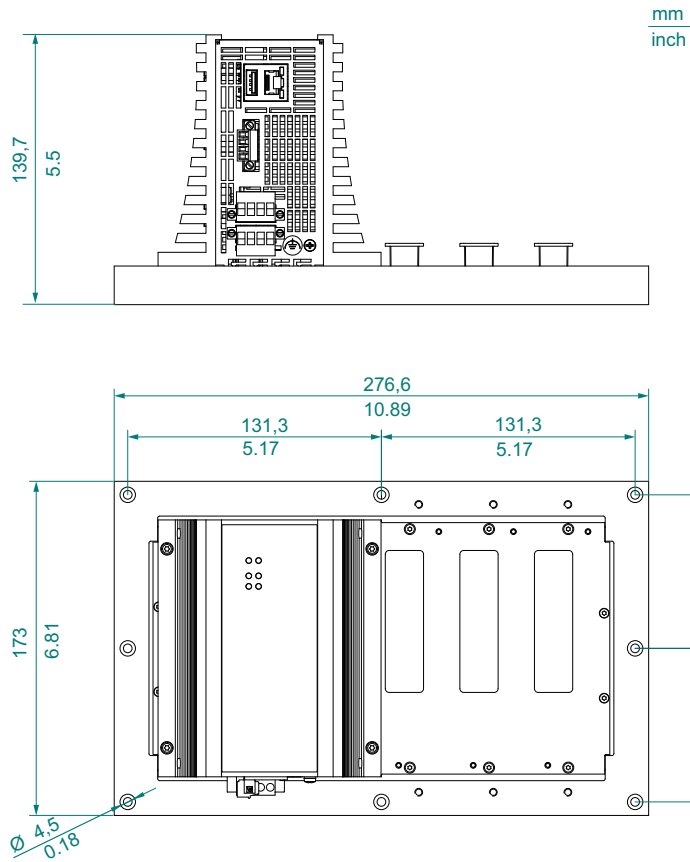

Figure 11: MSP30-0804.....HX...

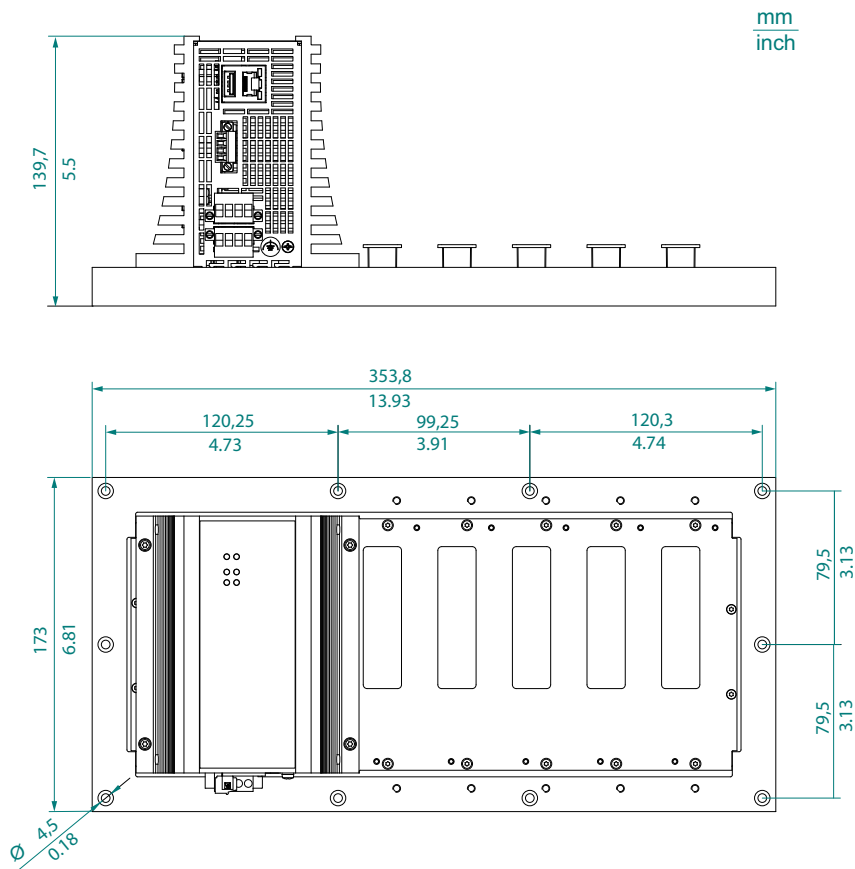

Figure 12: MSP30-1604.....HX...

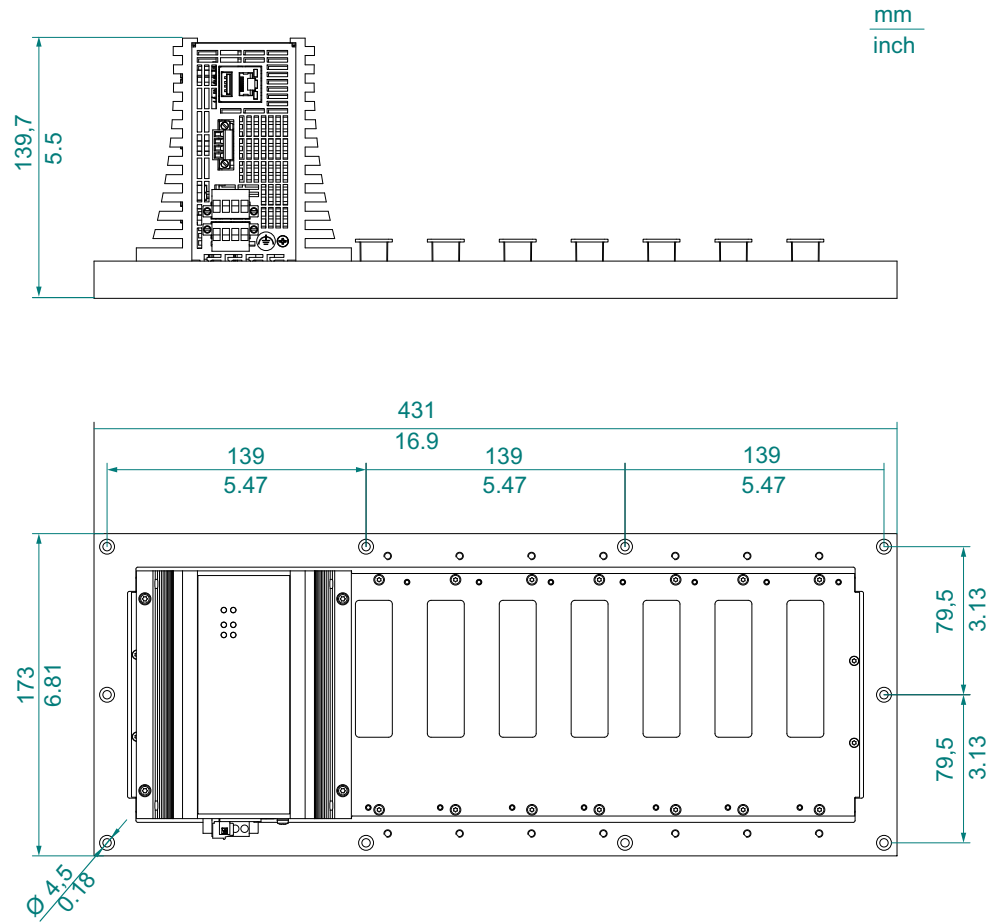

Figure 13: MSP30-2404.....HX...

## Media modules

mm  
inch

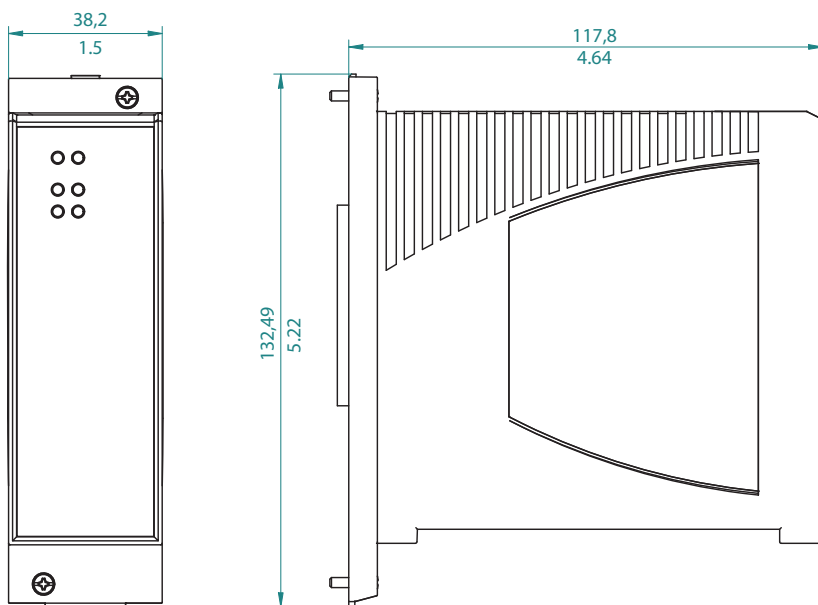

Figure 14: Dimensions for media modules with characteristic value HH



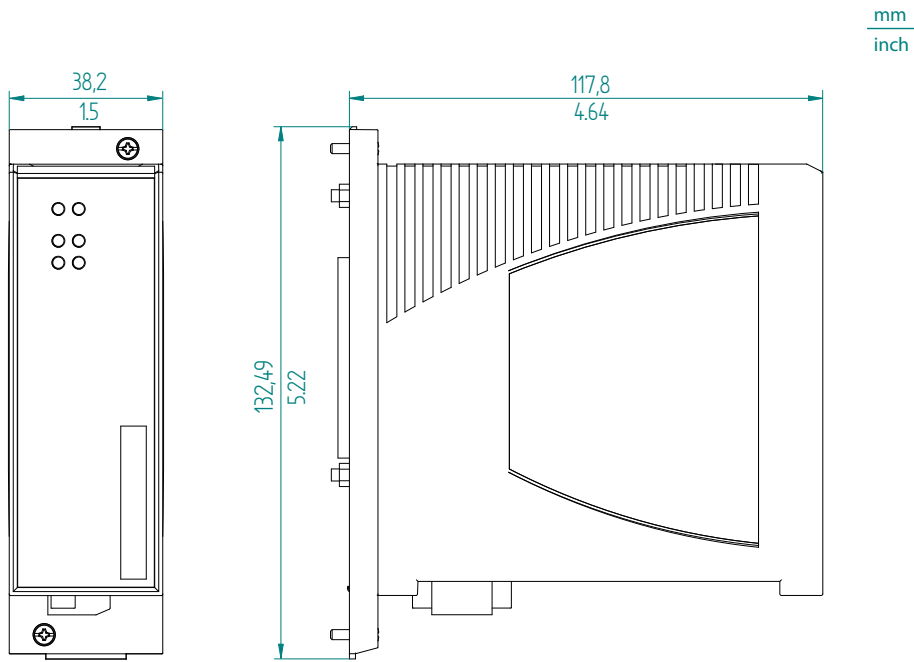

Figure 15: Dimensions for media module MSM46-T1T1T1T1... with characteristic value HH (with terminal block for external PoE supply voltage)

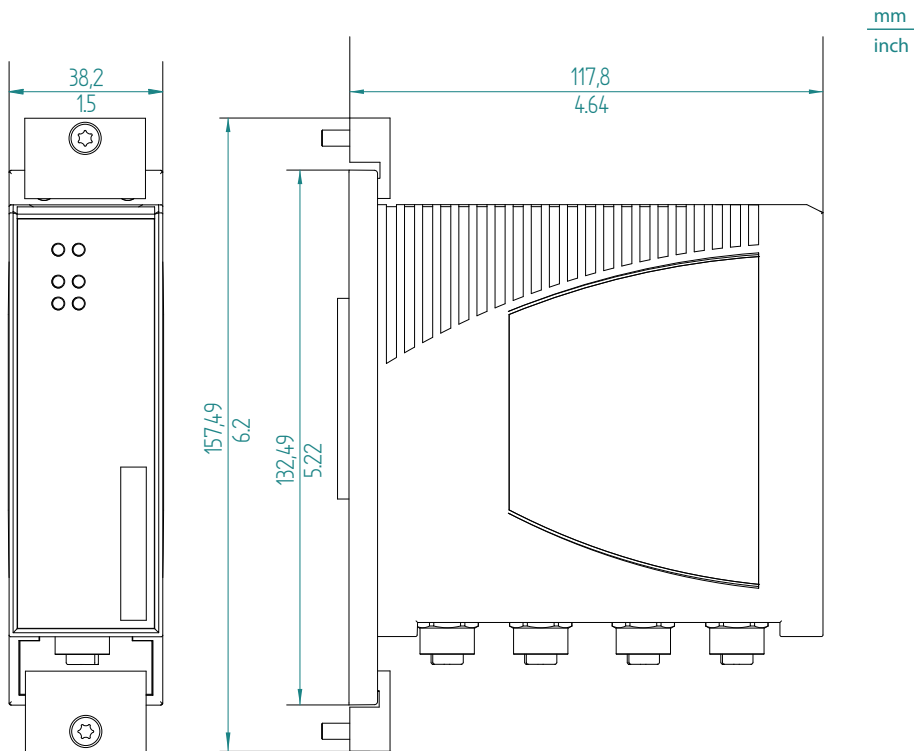

Figure 16: Dimensions for media modules with customer-specific version characteristic value HX

## 8.7 EMC and immunity

EMC interference emission		Standard applications <sup>a</sup>	Merchant Navy <sup>b</sup>	Railway applications (trackside) <sup>c</sup>	Substation applications <sup>d</sup>
<b>Radiated emission</b>					
EN 55022		Class A	Class A	Class A	Class A
DNV GL Guidelines		—	EMC 1	—	—
FCC 47 CFR Part 15		Class A	Class A	Class A	Class A
EN 61000-6-4		Fulfilled	Fulfilled	Fulfilled	Fulfilled
<b>Conducted emission</b>					
EN 55022	DC supply connection	Class A	Class A	Class A	Class A
DNV GL Guidelines	DC supply connection	—	EMC 1	—	—
FCC 47 CFR Part 15	DC supply connection	Class A	Class A	Class A	Class A
EN 61000-6-4	DC supply connection	Fulfilled	Fulfilled	Fulfilled	Fulfilled
EN 55022	Telecommunication connections	Class A	Class A	Class A	Class A
EN 61000-6-4	Telecommunication connections	Fulfilled	Fulfilled	Fulfilled	Fulfilled

a. EN 61131-2, CE, FCC – applies to all devices

b. Merchant Navy – applies to devices with the certification codes VU, U9, UY, UW, UX

c. EN 50121-4 – applies to devices with the certification codes VT, T9, TY

d. EN 61850-3, IEEE 1613 – applies to devices with the certification codes V9, VY, VU, VT

**Note:** The PoE media module MSM46 only complies with the requirements of the EMC directive if a suitable power supply unit is connected. Hirschmann recommends RPS 90/48V power supply units. See “Accessories” on page 89.

EMC interference immunity		Standard applications <sup>a</sup>	Merchant Navy <sup>b</sup>	Railway applications (trackside) <sup>c</sup>	Substation applications <sup>d</sup>
<b>Electrostatic discharge</b>					
EN 61000-4-2	Contact discharge	±4 kV	±6 kV	±6 kV	± 8 kV <sup>e</sup>
IEEE C37.90.3					

<b>EMC interference immunity</b>		<b>Standard applications<sup>a</sup></b>	<b>Merchant Navy<sup>b</sup></b>	<b>Railway applications (trackside)<sup>c</sup></b>	<b>Substation applications<sup>d</sup></b>
EN 61000-4-2 IEEE C37.90.3	Air discharge	±8 kV	±8 kV	±8 kV	±15 kV
<b>Electromagnetic field</b>					
EN 61000-4-3 IEEE 1613	80 MHz ... 3000 MHz 80 MHz ... 1000 MHz	10 V/m —	10 V/m —	20 V/m —	10 V/m 35 V/m
<b>Fast transients (burst)</b>					
EN 61000-4-4 IEEE C37.90.1	DC supply connection	±2 kV	±2 kV	±2 kV	±4 kV
EN 61000-4-4 IEEE C37.90.1	Data line	±4 kV	±4 kV	±2 kV	±4 kV
<b>Voltage surges - DC supply connection</b>					
EN 61000-4-5 IEEE 1613	line/ground line/ground	±2 kV —	±2 kV —	±2 kV —	±2 kV ±5 kV
EN 61000-4-5	line/line	±1 kV	±1 kV	±1 kV	±1 kV
<b>Voltage surges - data line</b>					
EN 61000-4-5	line/ground	±1 kV	±1 kV	±2 kV	±2 kV
<b>Conducted disturbances</b>					
EN 61000-4-6	150 kHz ... 80 MHz	10 V	10 V	10 V	10 V
<b>Damped vibration – DC supply connection</b>					
EN 61000-4-12 IEEE C37.90.1	line/ground	—	—	—	2.5 kV
EN 61000-4-12 IEEE C37.90.1	line/line	—	—	—	1 kV
<b>Damped oscillation - data line</b>					
EN 61000-4-12 IEEE C37.90.1	line/ground	—	—	—	2.5 kV
EN 61000-4-12	line/line	—	—	—	±1 kV
<b>Pulse magnetic field</b>					
EN 61000-4-9		—	—	300 A/m	—

- a. EN 61131-2, CE, FCC – applies to all devices
- b. Merchant Navy – applies to devices with the certification codes VU, U9, UY, UW, UX
- c. EN 50121-4 – applies to devices with the certification codes VT, T9, TY
- d. EN 61850-3, IEEE 1613 – applies to devices with the certification codes V9, VY, VU, VT
- e. Media modules MSM2x-T5T5T5T5...HH: 6 kV

Stability		Standard applications <sup>a</sup>	Merchant Navy <sup>b</sup>	Railway applications (trackside) <sup>c</sup>	Substation applications <sup>d</sup>
IEC 60068-2-6, test Fc	Vibration	5 Hz ... 8.4 Hz with 0.14 in. (3.5 mm) amplitude	2 Hz ... 13.2 Hz with 1 mm amplitude <sup>e</sup>	—	2 Hz ... 9 Hz with 0.11 in (3 mm) amplitude
		8.4 Hz ... 150 Hz with 1 g	13.2 Hz ... 200 Hz with 0.7 g <sup>e</sup>	—	9 Hz ... 200 Hz with 1 g
		—	—	—	200 Hz ... 500 Hz with 1.5 g
		—	2 Hz ... 25 Hz with 1.6 mm amplitude <sup>f</sup>	—	—
—	—	25.0 Hz ... 100 Hz with 4g <sup>f</sup>	—	—	—
IEC 60068-2-27, test Ea	Shock	15 g at 11 ms	—	—	10 g at 11 ms

- a. EN 61131-2, CE, FCC – applies to all devices
- b. Merchant Navy – applies to devices with the certification codes VU, U9, UY, UW, UX
- c. EN 50121-4 – applies to devices with the certification codes VT, T9, TY
- d. EN 61850-3, IEEE 1613 – applies to devices with the certification codes V9, VY, VU, VT
- e. Applies to device variants featuring customer-specific version with the characteristic value HH
- f. Applies to device variants featuring customer-specific version with the characteristic value HX

## 8.8 Power consumption/power output

The order numbers correspond to the product codes of the devices.  
See “Device name and product code” on page 20.

Device name	Maximum power consumption	Power output
MSP30-0804...	16.0 W	55.0 Btu (IT)/h
MSP30-1604...	17.0 W	58.0 Btu (IT)/h
MSP30-2404...	18.0 W	61.0 Btu (IT)/h
MSP32-0804...	17.0 W	58.0 Btu (IT)/h
MSP32-1604...	18.0 W	61.0 Btu (IT)/h
MSP32-2404...	19.0 W	65.0 Btu (IT)/h
MSP40-0012...	17.0 W	58.0 Btu (IT)/h
MSP40-0020...	19.0 W	65.0 Btu (IT)/h
MSP40-0028...	21.5 W	73.0 Btu (IT)/h
MSP42-0012...	18.0 W	61.0 Btu (IT)/h
MSP42-0020...	19.5 W	67.0 Btu (IT)/h
MSP42-0028...	22.5 W	77.0 Btu (IT)/h

Module <sup>a</sup>	Slot <sup>b</sup>	Maximum power consumption	Power output
<b>MSM20 media modules:</b>			
MSM20-xxT1T1T1...	GE	5.0 W	17.0 Btu (IT)/h
MSM20-xxT1T1T1...	FE	4.0 W	14.0 Btu (IT)/h
MSM20-xxxxT1T1...	GE	4.0 W	14.0 Btu (IT)/h
MSM20-xxxxT1T1...	FE	4.0 W	14.0 Btu (IT)/h
MSM20-xxxxxxx...	GE	5.0 W	17.0 Btu (IT)/h
MSM20-xxxxxxx...	FE	5.0 W	17.0 Btu (IT)/h
MSM20-T5T5T5T5...	FE	2.0 W	7.0 Btu (IT)/h
MSM22-T5T5T5T5...	FE	3.0 W	10.0 Btu (IT)/h
<b>MSM24 media modules:</b>			
MSM24-IOIOIOIO...	—	7.0 W	24.0 Btu (IT)/h
<b>MSM40 media modules:</b>			
MSM40-C1C1C1C1...	GE	5.0 W	17.0 Btu (IT)/h
MSM40-C1C1C1C1...	FE	5.0 W	17.0 Btu (IT)/h
MSM40-T1T1T1T1...	GE	3.0 W	10.0 Btu (IT)/h
MSM40-T1T1T1T1...	FE	2.0 W	7.0 Btu (IT)/h
<b>MSM42 media modules:</b>			
MSM42-T1T1T1T1...	GE	4.0 W	14.0 Btu (IT)/h
MSM42-T1T1T1T1...	FE	3.0 W	10.0 Btu (IT)/h
<b>MSM46 media modules:</b>			
MSM46-T1T1T1T1...	GE	4.0 W	14.0 Btu (IT)/h
MSM46-T1T1T1T1...	FE	3.0 W	10.0 Btu (IT)/h
<b>MSM50 media modules:</b>			
MSM50-Q6Q6Q6Q6...	GE	3.0 W	10.0 Btu (IT)/h
MSM50-Q6Q6Q6Q6...	2.5 GE	4.0 W	14.0 Btu (IT)/h

Table 44: Overview: Power consumption and power output

a. xx = M2, M4, S2, S4, L2, G2

b. FE= Fast Ethernet 100 MBit/s; GE= Gigabit Ethernet 1000 MBit/s

Media modules	Maximum power output
MSM22	62 W
MSM42	62 W
MSM46	124 W

Table 45: Maximum PoE power output

## 8.9 Network range

**Note:** The line lengths specified for the transceivers apply for the respective fiber data (fiber attenuation and BLP/dispersion).

Product code M-SFP-...	Mode <sup>a</sup>	Wave length	Fiber	System attenuation	Example for F/O cable length <sup>b</sup>	Fiber attenuation	BLP <sup>c</sup> /Dispersion
-SX/LC...	MM	850 nm	50/125 $\mu$ m	0 dB ... 7.5 dB	0 mi ... 0.34 mi (0 km ... 0.55 km)	3.0 dB/km	400 MHz $\times$ km
-SX/LC...	MM	850 nm	62.5/125 $\mu$ m	0 dB ... 7.5 dB	0 mi ... 0.17 mi (0 km ... 0.275 km)	3.2 dB/km	200 MHz $\times$ km
-MX/LC	MM	1310 nm	50/125 $\mu$ m	0 dB ... 8 dB	1.24 mi (2 km) <sup>d</sup>	1.0 dB/km	500 MHz $\times$ km
-MX/LC	MM	1310 nm	62.5/125 $\mu$ m	0 dB ... 8 dB	0.62 mi (1 km)	1.0 dB/km	500 MHz $\times$ km
-LX/LC...	MM	1310 nm <sup>e</sup>	50/125 $\mu$ m	0 dB ... 10.5 dB	0 mi ... 0.34 mi (0 km ... 0.55 km)	1.0 dB/km	800 MHz $\times$ km
-LX/LC...	MM	1310 nm <sup>f</sup>	62.5/125 $\mu$ m	0 dB ... 10.5 dB	0 mi ... 0.34 mi (0 km ... 0.55 km)	1.0 dB/km	500 MHz $\times$ km
-LX/LC...	SM	1310 nm	9/125 $\mu$ m	0 dB ... 10.5 dB	0 mi ... 12.43 mi (0 km ... 20 km) <sup>g</sup>	0.4 dB/km	3.5 ps/(nm $\times$ km)

Table 46: Fiber port 1000BASE-FX (SFP fiber optic Gigabit Ethernet Transceiver)

Product code M-SFP-...	Mode <sup>a</sup>	Wave length	Fiber	System attenuation	Example for F/O cable length <sup>b</sup>	Fiber attenuation	BLP <sup>c</sup> /Dispersion
-LX+/LC...	SM	1310 nm	9/125 μm	5 dB ... 20 dB	8.70 mi ... 26.10 mi (14 km ... 42 km)	0.4 dB/km	3.5 ps/(nm×km)
-LH/LC...	LH	1550 nm	9/125 μm	5 dB ... 22 dB	14.29 mi ... 49.71 mi (23 km ... 80 km)	0.25 dB/km	19 ps/(nm×km)
-LH+/LC	LH	1550 nm	9/125 μm	15 dB ... 30 dB	44.12 mi ... 67.11 mi (71 km ... 108 km)	0.25 dB/km	19 ps/(nm×km)
-LH+/LC	LH	1550 nm	9/125 μm	15 dB ... 30 dB	44.12 mi ... 79.54 mi (71 km ... 128 km)	0.21 dB/km (typically)	19 ps/(nm×km)

**Table 46: Fiber port 1000BASE-FX (SFP fiber optic Gigabit Ethernet Transceiver)**

- a. MM = Multimode, SM = Singlemode, LH = Singlemode Longhaul
- b. Including 3 dB system reserve when compliance with the fiber data is observed.
- c. Using the bandwidth-length product is inappropriate for expansion calculations.
- d. Distances of up to 1.86 mi (3 km) can be reached, 1000 MHz×km (1300 nm)
- e. With F/O adapter compliant with IEEE 802.3-2002 Clause 38 (single-mode fiber offset-launch mode conditioning patch cord).
- f. With F/O adapter compliant with IEEE 802.3-2002 Clause 38 (single-mode fiber offset-launch mode conditioning patch cord).
- g. Including 2.5 dB system reserve when compliance with the fiber data is observed.

Product code M-SFP-BIDI...	Mode <sup>a</sup>	Wave length TX	Wave length RX	Fiber	System attenuation	Example for F/O cable length <sup>b</sup>	Fiber attenuation	Dispersion
Type A LX/LC EEC	SM	1310 nm	1550 nm	9/125 μm	0 dB ... 11 dB	0 km ... 12.43 mi (0 km ... 20 km)	0.4 dB/km	3.5 ps/(nm×km)
Type B LX/LC EEC	SM	1550 nm	1310 nm	9/125 μm	0 dB ... 11 dB	0 mi ... 12.43 mi (0 km ... 20 km)	0.25 dB/km	19 ps/(nm×km)
Type A LH/LC EEC	LH	1490 nm	1590 nm	9/125 μm	5 dB ... 24 dB	14.29 mi ... 49.71 mi (23 km ... 80 km)	0.25 dB/km	19 ps/(nm×km)
Type B LH/LC EEC	LH	1590 nm	1490 nm	9/125 μm	5 dB ... 24 dB	14.29 mi ... 49.71 mi (23 km ... 80 km)	0.25 dB/km	19 ps/(nm×km)

**Table 47: F/O port (bidirectional Gigabit Ethernet SFP Transceiver)**

- a. MM = Multimode, SM = Singlemode, LH = Singlemode Longhaul
- b. Including 3 dB system reserve when compliance with the fiber data is observed.

Product code M-FAST-SFP-...	Mode <sup>a</sup>	Wave length	Fiber	System attenuation	Example for F/O cable length <sup>b</sup>	Fiber attenuation	BLP/Dispersion
-MM/LC...	MM	1310 nm	50/125 μm	0 dB ... 8 dB	0 mi ... 3.11 mi (0 km ... 5 km)	1.0 dB/km	800 MHz×km
-MM/LC...	MM	1310 nm	62.5/125 μm	0 dB ... 11 dB	0 mi ... 2.49 mi (0 km ... 4 km)	1.0 dB/km	500 MHz×km
-SM/LC...	SM	1310 nm	9/125 μm	0 dB ... 13 dB	0 mi ... 15.53 mi (0 km ... 25 km)	0.4 dB/km	3.5 ps/(nm×km)
-SM+/LC...	SM	1310 nm	9/125 μm	10 dB ... 29 dB	15.53 mi ... 40.39 mi (25 km ... 65 km)	0.4 dB/km	3.5 ps/(nm×km)
-LH/LC...	SM	1550 nm	9/125 μm	10 dB ... 29 dB	29.20 mi ... 64.62 mi (47 km ... 104 km)	0.25 dB/km	19 ps/(nm×km)
-LH/LC...	SM	1550 nm	9/125 μm	10 dB ... 29 dB	14.29 mi ... 86.99 mi (55 km ... 140 km)	0.18 dB/km <sup>c</sup>	18 ps/(nm×km)

*Table 48: Fiber port 100BASE-FX (SFP fiber optic Fast Ethernet Transceiver)*

- a. MM = Multimode, SM = Singlemode, LH = Singlemode Longhaul  
b. Including 3 dB system reserve when compliance with the fiber data is observed.  
c. With ultra-low-loss optical fiber.

#### 10/100/1000 Mbit/s twisted pair port

Length of a twisted pair segment                      max. 328 ft (100 m) (for Cat5e cable)

*Table 49: Network range: 10/100/1000 Mbit/s twisted pair port*



# 9 Scope of delivery, order numbers and accessories

## 9.1 Scope of delivery

### ■ Basic device

Number	Article
1 ×	Device (backplane and power module)
1 ×	General safety instructions
1 ×	4-pin terminal block for digital input
2 ×	4-pin terminal block for supply voltage

### ■ Media modules

Number	Article
1 ×	Device
1 ×	General safety instructions
2 ×	Only with the customer-specific version with characteristic value HX Hardware elements with screws M4 × 12
1 ×	Only with media module MSM24 2-pin terminal block for 24 V DC auxiliary voltage 8-pin terminal block for digital input 12-pin terminal block for digital output
1 ×	Only with media module MSM46 3-pin terminal block for external PoE power supply

## 9.2 Accessories

Designation	Order number
AutoConfiguration Adapter ACA21-USB (EEC) <sup>a</sup>	943 271-003
AutoConfiguration Adapter ACA22-USB (EEC)	942 124-001
AutoConfiguration Adapter ACA31	942 074-001
Network management software Industrial HiVision	943 156-xxx
Terminal cable: RJ45 on USB	942 096-001
Terminal cable: RJ45 on Sub-D, 9-pin	942 097-001
RPS 90/48V HV (high-voltage) PoE power unit	943 979-001
RPS 90/48V LV (low-voltage) PoE power unit	943 980-001

- a. The AutoConfiguration Adapter ACA21-USB (EEC) is only compatible with MSP30/32 basic devices.

<b>2.5 Gigabit Ethernet SFP transceiver</b>	<b>Order number</b>
M-SFP-2.5-MM/LC EEC	942 162-001
M-SFP-2.5-SM-/LC EEC	942 163-001
M-SFP-2.5-SM/LC EEC	942 164-001
M-SFP-2.5-SM+/LC EEC	942 165-001

<b>Gigabit Ethernet SFP transceiver</b>	<b>Order number</b>
M-SFP-TX/RJ45	943 977-001
M-SFP-TX/RJ45 EEC	942 161-001

The following operating conditions apply to twisted pair transceivers:

- ▶ Usable with:
  - HiOS as of software version 03.0.00
  - Classic Switch software, as of software version 04.1.00.
  - HiSecOS as of software version 01.2.00
- Do not use with the following devices:
  - SPIDER II- MSP/MSM
  - EES
- ▶ Longer RSTP switching times and link loss detection times compared to twisted pair ports provided by the device directly.
- ▶ Not applicable for combo and Fast Ethernet ports.
- ▶ Only support of the autonegotiation mode including autocrossing.

M-SFP-SX/LC	943 014-001
M-SFP-SX/LC EEC	943 896-001
M-SFP-MX/LC EEC	942 108-001
M-SFP-LX/LC	943 015-001
M-SFP-LX/LC EEC	943 897-001
M-SFP-LX+/LC	942 023-001
M-SFP-LX+/LC EEC	942 024-001
M-SFP-LH/LC	943 042-001
M-SFP-LH/LC EEC	943 898-001
M-SFP-LH+/LC	943 049-001
M-SFP-LH+/LC EEC	942 119-001
SFP-GIG-LX/LC <sup>a</sup>	942 196-001
SFP-GIG-LX/LC EEC <sup>a</sup>	942 196-002

- a. You find further information on certifications on the Internet at the Hirschmann product pages ([www.hirschmann.com](http://www.hirschmann.com)).

<b>Bidirectional Gigabit Ethernet SFP transceiver</b>	<b>Order number</b>
M-SFP-BIDI Type A LX/LC EEC	943 974-001
M-SFP-BIDI Type B LX/LC EEC	943 974-002
M-SFP-BIDI Type A LH/LC EEC	943 975-001
M-SFP-BIDI Type B LH/LC EEC	943 975-002
M-SFP-BIDI Bundle LX/LC EEC (type A + B)	943 974-101
M-SFP-BIDI Bundle LH/LC EEC (type A + B)	943 975-101

Fast Ethernet SFP transceiver	Order number
M-FAST SFP-TX/RJ45	942 098-001
M-FAST SFP-TX/RJ45 EEC	942 098-002
The following operating conditions apply to twisted pair transceivers:	
<ul style="list-style-type: none"> <li>▶ Usable with: <ul style="list-style-type: none"> <li>- HiOS as of software version 03.0.00</li> <li>- for PRP ports on RSP devices, as of software version 02.0.01</li> <li>- for PRP ports on EES devices, as of software version 02.0.02</li> <li>- Classic switch software as of software version 08.0.00</li> <li>- HiSecOS as of software version 01.2.00</li> </ul> </li> <li>▶ Longer RSTP switching times and link loss detection times compared to twisted pair ports provided by the device directly.</li> <li>▶ Not applicable for combo ports.</li> <li>▶ Not applicable for ports which support only Gigabit Ethernet.</li> <li>▶ To set autocrossing manually is currently not possible.</li> </ul>	
M-FAST SFP-MM/LC	943 865-001
M-FAST SFP-MM/LC EEC	943 945-001
M-FAST SFP-SM/LC	943 866-001
M-FAST SFP-SM/LC EEC	943 946-001
M-FAST SFP-SM+/LC	943 867-001
M-FAST SFP-SM+/LC EEC	943 947-001
M-FAST SFP-LH/LC	943 868-001
M-FAST SFP-LH/LC EEC	943 948-001
SFP-FAST-MM/LC <sup>a</sup>	942 194-001
SFP-FAST-MM/LC EEC <sup>a</sup>	942 194-002
SFP-FAST-SM/LC <sup>a</sup>	942 195-001
SFP-FAST-SM/LC EEC <sup>a</sup>	942 195-002

a. You find further information on certifications on the Internet at the Hirschmann product pages ([www.hirschmann.com](http://www.hirschmann.com)).

**Note:** Some products recommended as accessories do not support the entire temperature range specified for the device and can thus restrict the possible range of usage for the overall system.

# 10 Underlying technical standards

Designation	
CSA C22.2 No. 142	Canadian National Standard(s) – Process Control Equipment Industrial Products
EN 50121-4	Railway applications – EMC – Emission and immunity of the signaling and telecommunications apparatus (Rail Trackside)
EN 55022	Information technology equipment – Radio disturbance characteristics – Limits and methods of measurement
EN 55032	Electromagnetic compatibility of multimedia equipment – Emission Requirements
EN 60950-1	Information technology equipment – Safety – Part 1: General requirements
EN 61000-6-2	Electromagnetic compatibility (EMC) – Part 6-2: Generic standards – Immunity for industrial environments
EN 61131-2	Programmable controllers – Part 2: Equipment requirements and tests
FCC 47 CFR Part 15	Code of Federal Regulations
DNVGL-CG-0339	Environmental test specification for electrical, electronic and programmable equipment and systems
IEC/EN 61850-3	Communications networks and systems in stations
IEEE 1613	Standard Environment and Testing Requirements for Communication Networking Devices in Electric Power Substations
IEEE 802.1AB	Station and Media Access Control Connectivity Discovery
IEEE 802.1D	Media Access Control Bridges
IEEE 802.1Q	Virtual Bridged Local Area Networks
IEEE 802.3	Ethernet
ISA-12.12.01	Nonincendive Electrical Equipment for Use in Class I and II, Division 2 and Class III, Divisions 1 and 2 Hazardous (Classified) Locations
NEMA TS 2	Traffic Controller Assemblies with NTCIP Requirements (environmental requirements)
UL 508	Safety for Industrial Control Equipment

*Table 50: List of norms and standards*

The device has an approval based on a specific standard only if the approval indicator appears on the device casing.

If your device has a shipping approval according to DNV GL, you find the respective approval mark printed on the device label. You will find out whether your device has other shipping approvals on the Hirschmann website under [www.hirschmann.com](http://www.hirschmann.com) in the product information.

The device generally fulfills the technical standards named in their current versions.

# A Further support

## Technical questions

For technical questions, please contact any Hirschmann dealer in your area or Hirschmann directly.

You find the addresses of our partners on the Internet at <http://www.hirschmann.com>.

A list of local telephone numbers and email addresses for technical support directly from Hirschmann is available at <https://hirschmann-support.belden.com>.

This site also includes a free of charge knowledge base and a software download section.

## Hirschmann Competence Center

The Hirschmann Competence Center is ahead of its competitors on three counts with its complete range of innovative services:

- ▶ Consulting incorporates comprehensive technical advice, from system evaluation through network planning to project planning.
- ▶ Training offers you an introduction to the basics, product briefing and user training with certification.  
You find the training courses on technology and products currently available at <http://www.hicomcenter.com>.
- ▶ Support ranges from the first installation through the standby service to maintenance concepts.

With the Hirschmann Competence Center, you decided against making any compromises. Our client-customized package leaves you free to choose the service components you want to use.

Internet:

<http://www.hicomcenter.com>



**HIRSCHMANN**

---

A **BELDEN** BRAND