



**HIRSCHMANN**

A **BELDEN** BRAND

# User Manual

## Installation and Operation Dragon PTN



The naming of copyrighted trademarks in this manual, even when not specially indicated, should not be taken to mean that these names may be considered as free in the sense of the trademark and tradename protection law and hence that they may be freely used by anyone.

© 2018 Hirschmann Automation and Control GmbH

Manuals and software are protected by copyright. All rights reserved. The copying, reproduction, translation, conversion into any electronic medium or machine scannable form is not permitted, either in whole or in part. An exception is the preparation of a backup copy of the software for your own use.

The performance features described here are binding only if they have been expressly agreed when the contract was made. This document was produced by Hirschmann Automation and Control GmbH according to the best of the company's knowledge. Hirschmann reserves the right to change the contents of this document without prior notice. Hirschmann can give no guarantee in respect of the correctness or accuracy of the information in this document.

Hirschmann can accept no responsibility for damages, resulting from the use of the network components or the associated operating software. In addition, we refer to the conditions of use specified in the license contract.

You can get the latest version of this manual on the Internet at the Hirschmann product site ([www.hirschmann.com](http://www.hirschmann.com)).

Hirschmann Automation and Control GmbH  
Stuttgarter Str. 45-51  
72654 Neckartenzlingen  
Germany

## Contents

<b>1.</b>	<b>INTRODUCTION .....</b>	<b>8</b>
<b>1.1</b>	<b>Terms and Conditions .....</b>	<b>8</b>
<b>1.2</b>	<b>General.....</b>	<b>8</b>
<b>1.3</b>	<b>Symbol Clarification .....</b>	<b>9</b>
1.3.1	Engineer Type Symbols.....	9
1.3.2	Informational Symbols.....	9
<b>1.4</b>	<b>CE Marking &amp; Directives.....</b>	<b>10</b>
<b>1.5</b>	<b>Safety Advice .....</b>	<b>10</b>
1.5.1	Introduction .....	10
1.5.2	Electrical Advice.....	10
1.5.3	Thermal Advice .....	10
1.5.4	Designated Use .....	11
1.5.5	Cables (Lines) to the Dragon PTN Equipment .....	11
1.5.6	Checking of Safety Facilities .....	11
1.5.7	Work on the Electrical Systems .....	11
1.5.8	Ingress of Cleaning Agents.....	11
<b>1.6</b>	<b>Lifting Advice .....</b>	<b>11</b>
1.6.1	Plan the Lift.....	11
1.6.2	Performing the Lift.....	11
1.6.3	Setting the Load Down .....	11
1.6.4	Team Lifting .....	12
<b>1.7</b>	<b>Administration.....</b>	<b>12</b>
<b>1.8</b>	<b>Tools &amp; Materials.....</b>	<b>13</b>
<b>1.9</b>	<b>Prerequisites.....</b>	<b>16</b>
1.9.1	Drafting a Site Plan .....	16
1.9.2	Installing the Optical Cable.....	16
1.9.3	Unpacking and Checking the Supplied Goods .....	16
1.9.4	Preparing the Rack.....	16
<b>1.10</b>	<b>Installing / Configuring / Connecting Nodes.....</b>	<b>17</b>
<b>2.</b>	<b>RACK PREPARATION .....</b>	<b>19</b>
<b>3.</b>	<b>NODES – INSTALLATION FORMS .....</b>	<b>23</b>
<b>3.1</b>	<b>General.....</b>	<b>23</b>
<b>3.2</b>	<b>Power ON/OFF a Node or Switch.....</b>	<b>23</b>
<b>3.3</b>	<b>EMC Springs.....</b>	<b>24</b>
<b>3.4</b>	<b>Card Guides inside the Node .....</b>	<b>24</b>
<b>3.5</b>	<b>Node Module Positions.....</b>	<b>25</b>
<b>3.6</b>	<b>XT-1104-A Node (942 228-001).....</b>	<b>28</b>
<b>3.7</b>	<b>XT-2206-A Node (942 228-002).....</b>	<b>34</b>
<b>3.8</b>	<b>XT-2209-A Node (942 228-003).....</b>	<b>39</b>
<b>3.9</b>	<b>XT-2210-A Node (942 228-004).....</b>	<b>41</b>
<b>4.</b>	<b>POWER SUPPLIES – INSTALLATION FORMS .....</b>	<b>44</b>
<b>4.1</b>	<b>PSU Types for Dragon PTN Nodes.....</b>	<b>44</b>
<b>4.2</b>	<b>PSU Cables.....</b>	<b>45</b>

4.3	IT Grounding System .....	47
4.4	Safety and Power Distribution .....	47
4.5	ACP-A: 100-240 VAC $\pm$ 10 % - PSU (942 234-001) .....	48
4.6	DCP-A: 18-60 VDC PSU (942 234-002) .....	49
4.7	DCP-B: 88-300 VDC PSU (942 234-003).....	51
4.8	ACPoE-A DIN Rail PSU/100-240 VAC $\pm$ 10 % - 48 VDC DIN RAIL PSU (942 235-001) .....	53
4.9	DCPoE-A DIN Rail PSU/ 33-62 VDC(in) - 56 VDC(out) DIN RAIL PSU (942 235-002) .....	55
5.	NODE SUPPORT MODULES – INSTALLATION FORMS .....	59
5.1	NSM-A (942 229-001), NSM-B (942 229-002) .....	61
6.	CENTRAL SWITCHING MODULE – INSTALLATION FORMS.....	67
6.1	General.....	67
6.2	CSM310-A (942 230-001).....	68
7.	INTERFACE MODULES – INSTALLATION FORMS.....	76
7.1	General Recommendations: Optical Connectors, Laser Diodes and Fibers	77
7.2	2-C37.94 (With E1: 942 236-009 / With T1: 942 236-010) .....	78
7.3	4-DSL-LW (942 236-007) .....	82
7.4	4-E1-L/4-T1-L (942 236-010/ 942 236-011) .....	87
7.5	16-E1-L/16-T1-L (942 236-012/942 236-013) .....	91
7.6	8-FXS (future support).....	98
7.7	4-GC-LW (942 236-001), 4-GCB-LW (942 236-008) .....	103
7.8	7-SERIAL (942 236-014) .....	107
7.9	1-10G-LW (942 236-004).....	121
7.10	4-2/4WEM (future support) .....	124
7.11	4-CODIR (future support) .....	127
7.12	4-GO-LW (942 236-002).....	130
7.13	2-OLS (with E1: future support / with T1: future support) .....	133
7.14	9-L3A-L (942 236-005) .....	136
7.15	Optical Transceiver/Receiver Modules (SFP, XFP) .....	139
8.	CABLES .....	141
8.1	Introduction .....	141
8.2	Color Codes .....	141
9.	ADD NEW NODE TO A LIVE NETWORK .....	143
9.1	Introduction .....	143
9.2	Steps .....	143
10.	INSTALLATION FILE .....	145
10.1	Optical Power Measurements .....	145
11.	THIRD-PARTY EQUIPMENT .....	147

<b>12.</b>	<b>REPAIR .....</b>	<b>149</b>
<b>13.</b>	<b>FINAL INSTALLATION ACTIVITIES .....</b>	<b>151</b>
<b>14.</b>	<b>PREVENTIVE MAINTENANCE .....</b>	<b>153</b>
<b>14.1</b>	<b>Visual Inspection of the Equipment .....</b>	<b>153</b>
<b>14.2</b>	<b>Measure Network Path Delays and Message Loss.....</b>	<b>153</b>
<b>14.3</b>	<b>Optical Measurements.....</b>	<b>153</b>
<b>14.4</b>	<b>Test Node PSU Redundancy and UPS (Uninterruptable Power Supply).....</b>	<b>153</b>
14.4.1	Test Node PSU Redundancy, Load Sharing.....	153
14.4.2	Test UPS.....	154
<b>14.5</b>	<b>HiProvision .....</b>	<b>154</b>
<b>14.6</b>	<b>Helpdesk.....</b>	<b>154</b>
<b>14.7</b>	<b>System Documentation.....</b>	<b>154</b>
<b>14.8</b>	<b>Repair Stock.....</b>	<b>154</b>
<b>14.9</b>	<b>Health Check and System Upgrade .....</b>	<b>154</b>
<b>15.</b>	<b>MANUALS REFERENCE LIST.....</b>	<b>156</b>
<b>16.</b>	<b>ABBREVIATIONS LIST.....</b>	<b>158</b>
<b>17.</b>	<b>GENERAL NODE DATA .....</b>	<b>161</b>
<b>18.</b>	<b>ESD RECOMMENDATIONS .....</b>	<b>163</b>
<b>18.1</b>	<b>General.....</b>	<b>163</b>
<b>18.2</b>	<b>Identification and Packaging of ESD Modules .....</b>	<b>163</b>
18.2.1	Static Protective Packaging.....	163
<b>18.3</b>	<b>Handling of ESD Modules .....</b>	<b>165</b>
18.3.1	General Guidelines and Precautions .....	165
18.3.2	ESD Guidelines upon Receipt.....	165
18.3.3	Handling.....	165
18.3.4	Protective Guidelines for Workshop Equipment.....	166
<b>18.4</b>	<b>Storage of ESD Modules.....</b>	<b>166</b>
<b>18.5</b>	<b>Transportation of ESD Modules.....</b>	<b>166</b>
<b>18.6</b>	<b>Handling and Transportation of Racks and Systems .....</b>	<b>167</b>
<b>18.7</b>	<b>Summary of Rules to be Obeyed .....</b>	<b>167</b>

## Document Revision level

Issue	Modification	Date
01	Creation of document	February 2018

## Introduction

## 1. INTRODUCTION

### 1.1 Terms and Conditions

In no event shall the supplier be liable under this agreement for any indirect, special, consequential, punitive or incidental damages of any nature whatsoever, nor for any loss of profits, revenue, use or loss of data, before or after acceptance. In no event shall supplier's total liability for any cause of action arising under this agreement be higher than the total contract amount.

### 1.2 General

This document is valid as of Dragon PTN Release 3.0DR.

This manual contains the procedures required for installing a Dragon PTN network. We recommend that trained installers with practical experience in installation of telecommunication equipment will carry out the installation.

There are two major steps in installing the Dragon PTN network:

1. Install the hardware equipment (Installation Engineer, see §1.3).
2. Configure the hardware + software (Service Engineer, see §1.3).

The HiProvision (=Dragon PTN Management System) is a software tool to manage Dragon PTN networks. It provides all the functions required for configuring, administrating, maintaining and monitoring the Dragon PTN networks. Refer to the 'Dragon PTN and HiProvision Operation' manual DRA-DRM821-&-\* with '&' the language code and '\*' the issue number supplied with your system.

---

For additional support, contact the Hirschmann helpdesk via <https://hirschmann-support.belden.eu.com>. Before contacting the Hirschmann helpdesk, please have following information ready :





- ▶ A description of your network environment (network design, cabling, ...);
  - ▶ A description of the failure;
  - ▶ A description of any action(s) already taken to resolve the problem (e.g. exchange of HW modules, rebooting the system, ...);
  - ▶ HiProvision Version (HiProvision = Dragon PTN Management System);
  - ▶ The issue / revision number of the involved HW modules (and firmware);
  - ▶ The device history (i.e. have you returned the device before, is this problem a recurring problem....);
  - ▶ Any previous repair reference (ERO, RMA number);
-



## 1.3 Symbol Clarification









### 1.3.1 Engineer Type Symbols

We consider two types of engineers:

Engineer type	Icon	Description
<b>Level 1 = Installation Engineer, hardware only</b>		A qualified person who is familiar with safety aspects. This person is responsible for the proper <b>installation</b> of the Dragon PTN equipment, according to the given installation forms (forms, see further in this manual). A 'Level 2' engineer does the configuration.
<b>Level 2 = Service Engineer, hardware + software</b>		A qualified person, trained by Hirschmann, who is familiar with safety aspects. This person's responsibility is to <b>configure</b> all the installed Dragon PTN hardware and software according to the given installation forms (forms, see further in this manual) and make the Dragon PTN network operational.
<b>Duration</b>	Duration: y min y hour(s)	Duration indicates the possible amount of time that the Installation Engineer might need to install/configure the Dragon PTN product. Depending on the experience of the Installation Engineer, this duration time could vary.

### 1.3.2 Informational Symbols

Find below a list of symbols used in this manual:

Symbol	Icon	Description
<b>ESD</b>		<b>CAUTION!</b> Avoid equipment damage from electrostatic discharge by using an antistatic wristband.
<b>Temperature</b>		<b>CAUTION!</b> Some parts of the node can be extremely hot.
<b>Laser</b>		<b>CAUTION!</b> When optically connecting the node, avoid looking straight into the optical fiber or optical transmitter.
<b>Attention</b>		Attract the attention on a specific action or handling of the engineer during installation and/or configuration.
<b>Information</b>		Gives the user additional information about a specific action or handling.
<b>Protective Earth</b>		This symbol is mentioned when installing a node and connecting the node to the protective earth of a rack.
<b>Compatible</b>		Compatible with the mentioned Node type
<b>Not Compatible</b>		Not compatible with the mentioned Node type

## 1.4 CE Marking & Directives

See the 'Dragon PTN General Specifications' manual DRA-DRM810-&-\* with '&' the language code and '\*' the issue number supplied with your system.



All installation instructions in this manual such as the use of shielded cables must be observed for Dragon PTN to comply with the European Directives quoted. When Dragon PTN is used as part of a larger communication system, verify whether the other products are carrying the mandatory CE marking and check whether the system is composed according to the instructions of the different product suppliers.

---

## 1.5 Safety Advice

### 1.5.1 Introduction

The safety advice contained in this section helps to prevent risks to life when operating or working with the Dragon PTN equipment, as well as damage to the Dragon PTN equipment.

Install the Dragon PTN equipment only in a restricted access location;



**Please observe the advice in the paragraphs below in order to prevent risks to life.**

---

### 1.5.2 Electrical Advice

Different Dragon PTN products or nodes require different PSUs with each PSU its own installation instruction and electrical safety advice. **ATTENTION:** Especially read the chapters in the bulleted list below for electrical safety advice depending on the required products.



- ▶ §4.1 PSU Types
  - ▶ §4.2 PSU Cables
  - ▶ §4.3 IT Grounding System
  - ▶ §4.4 Safety and Power Distribution
- 

### 1.5.3 Thermal Advice

Due to the fact that the Dragon PTN nodes have no rotating parts for cooling (except for the 9-L3A-L IFM), the node and interface modules can be extremely hot in some environments.



**CAUTION: Some parts of the node can be extremely hot. Therefore, it is strongly advised to use only the front panel handles of the module (NSM, CSM, IFM & PSU). Do not touch the PCB or any other parts when removing it from the node:**

- ▶ Node Support Module: NSM
  - ▶ Central Switching Module: CSM
  - ▶ Interface Module: IFM
  - ▶ Power Supply Unit: PSU
-

#### 1.5.4 Designated Use

Operate or work with the Dragon PTN equipment only within the scope of its designated use.

#### 1.5.5 Cables (Lines) to the Dragon PTN Equipment

Install all the lines to the Dragon PTN rack in such a way that:

- ▶ Other persons cannot trip over them;
- ▶ Safe minimum clearances are maintained;
- ▶ They do not obstruct the operation of the Dragon PTN equipment.

#### 1.5.6 Checking of Safety Facilities

Check all the safety facilities immediately after the installation of the Dragon PTN equipment.

#### 1.5.7 Work on the Electrical Systems

Work on the electrical systems may only performed by suitably qualified personnel.

#### 1.5.8 Ingress of Cleaning Agents

Do not allow cleaning agents to enter into the Dragon PTN rack. The 'integrated circuits' of the Dragon PTN modules are especially at risk.

### 1.6 Lifting Advice

---



If you cannot eliminate the manual handling risk and it is not practicable to use mechanical aids use the correct safe lifting technique to help prevent injury.

---

#### 1.6.1 Plan the Lift

- ▶ Try to break down the load into smaller parts;
- ▶ Check the pathway for any obstacles and clear these. Check if any doors need to be opened;
- ▶ Test the weight of the load by lifting one corner. If it is too heavy or awkward, stop and request help;

#### 1.6.2 Performing the Lift

- ▶ Stand with feet shoulder width apart and in a staggered stance;
- ▶ Move in close to the load;
- ▶ Bend your knees, keep your head upright and maintain the spine's natural curves;
- ▶ Pull the load close to your body;
- ▶ Secure your grip;
- ▶ Use a smooth controlled motion to lift the load;
- ▶ Avoid twisting or turning your body when lifting and be sure to use your feet to change direction;

#### 1.6.3 Setting the Load Down

- ▶ Stand with your feet apart and in a staggered stance;

- ▶ Get as close as possible to the area you will place the load;
- ▶ Bend your knees, keep your head upright and maintain the spine's natural curves;
- ▶ Keep the load close;
- ▶ Once the load is where you want it release your grip. Always ensure that the load is secured before you release your grip;

#### 1.6.4 Team Lifting

- ▶ Before undertaking a team lift it is important to establish emergency commands should one of you experience difficulty during the exercise;
- ▶ If you are lifting a load with team member(s) it is vital to keep communicating with that person(s) and tell them of any action you are about to take such as lowering or adjusting the load;



**Remember to 'keep the load close' and 'keep the natural curves of your spine' to help prevent injury.**

---

#### 1.7 Administration

During the installation of a node, PSUs, CSM, NSM or IFM, write down the hardware edition and serial number of each hardware product. Use the documents in chapter 17 to do this. If necessary, make additional copies for each node and keep them in an installation file.

- ▶ Serial Number:
  - ▶ For nodes: on the right-hand side of the node;
  - ▶ For PSUs, CSMs, NSMs and IFMs: on a label placed on the backside of the PCB (=Print Circuit Board);



## 1.8 Tools & Materials

For proper installation of the Dragon PTN equipment, the following tools are required:



Upon request, Hirschmann can order the tools and installation equipment in the table below.

Tool	Description
<b>Screwdriver set</b>	A screwdriver set of flat and crossed heads is required for installing Dragon PTN equipment.

**Cable tools set**

▶ Cable cutter, crimping tool for wire terminal. (All in one tool shown)

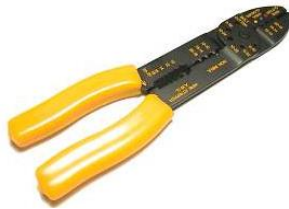

▶ Cable clamping tool



When connecting the interface cables to termination blocks, following items are preferred. The termination block below defines all the detailed interface cable connectivity (see interface forms).

▶ 10 pair termination block (KRÖNE: ref. n° 6089-1-121-02)

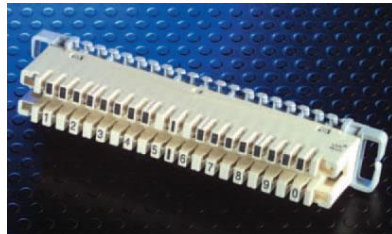

▶ Termination tool



**Labels**

Foresee industrial labels to identify all installed Dragon PTN equipment and connected cables. Identification can be done e.g. the IEC 61346-2 norm.

**Mounting equipment**

Find below the most common equipment for installing the Dragon PTN.

▶ M6 cage nuts, bolts and plastic cup washers are required for a proper installation of the node(s) inside a 19 inch rack.



- ▶ top hat rail EN 50022 – 35 × 7.5
- ▶ top hat rail EN 50022 – 35 × 15



- ▶ Cable ducts



- ▶ Cable ties



- ▶ Shrink sleeve

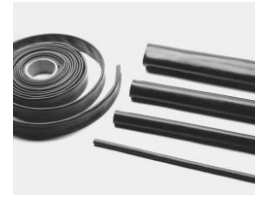

**Electrical equipment**

- ▶ Terminal blocks

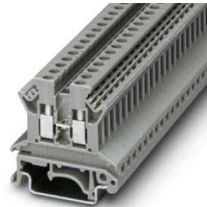

- ▶ Circuit breakers (Type C)



- ▶ Earthing wires 6 mm<sup>2</sup>



- ▶ Bootlace ferrules



**Measurement equipment**

- ▶ Tester or multi meter for voltage, current and resistance measuring



- ▶ Optical power meter



---

**Antistatic  
wristband**

Always use an antistatic wristband when installing the Dragon PTN equipment. Attach the antistatic wristband to the blank metal of the rack.



---

**Fiber Cleaning  
tool**



For detailed cleaning advice, see the instructions that are included in your cleaning kit.

---

## **1.9 Prerequisites**

Consider some prerequisites for a proper installation of the Dragon PTN equipment and the other equipment.

### **1.9.1 Drafting a Site Plan**

Hirschmann Automation and Control GmbH offers all the support required for configuring the nodes as economically as possible while maintaining sufficient flexibility for carrying out future adjustments easily.

### **1.9.2 Installing the Optical Cable**

Refer to the cable supplier's guidelines for installing the optical cable. Carry out the test procedures required.

### **1.9.3 Unpacking and Checking the Supplied Goods**

We recommended moving all the equipment for each site to the final location in its original packaging cases/crates. Unpack all the equipment at this final location.

Follow the steps below:

1. Exercise all possible care while moving the equipment to the specified site Communication Equipment Room.
2. Unpack only one case/crate at a time. If the outer packaging material is damaged and you suspect some internal equipment may have been damaged in transit, do not continue with the unpacking of that item, but obtain advice from your supervisor. Contact Hirschmann Automation and Control GmbH if any irregularity shows.
3. Check the delivered items against the equipment delivery note.
4. Ensure that no small parts, cables, or any other items are left in the packaging crates.
5. Repeat the above steps until all the equipment has been unpacked.
6. Subject all the unpacked equipment to a careful visual inspection, recording any observed damage. Report any damage to your supervisor for subsequent communication with Hirschmann Automation and Control GmbH.
7. Carefully move the unpacked equipment to the required position within the Communication Equipment Room.
8. Once the unpacking is complete, clear that the room of all packaging material in accordance with site regulations.

### **1.9.4 Preparing the Rack**

See Chapter 2.



## 1.10 Installing / Configuring / Connecting Nodes

---



- ▶ With all installation activities, adopt the ESD recommendations regarding the handling, transportation and storage of modules (see chapter 18).
  - ▶ The NSM for the XT-2210-A, XT-2209-A, XT-2206-A and XT-1104-A node is pre-installed (The NSM must be ordered separately).
  - ▶ Read chapter 2 before installing the nodes inside a rack.
- 

For each Dragon PTN hardware product, an **installation form** further on in this document can be consulted for a proper installation. On top of each form, the name of the Dragon PTN part and the Dragon PTN reference number are mentioned.

Example: 4-E1-L (942 236-010) with 4-E1-L = product name and 942 236-010 = reference number

If the nodes have **already** been **configured** (= all modules have been plugged into the node **already**), follow the steps below:

- ▶ check the straps/dip switches on the NSM → Chapter 5
- ▶ check the straps/dip switches on the CSM(s) → Chapter 6
- ▶ check the straps/dip switches on the interface module(s) , connect the fiber/node(s) and connect the interface cable(s) → Chapter 7



If the nodes have **not** been **configured** yet, follow the steps below:

- ▶ Install a node (empty) inside a 19" rack → Chapter 3
- ▶ Install a power supply → Chapter 4
- ▶ Install an NSM → Chapter 5
- ▶ Install a CSM → Chapter 6
- ▶ Install an interface module → Chapter 7
- ▶ Install interface cables → Chapter 8
- ▶ Add new node to a live network → Chapter 9

## **Rack Preparation**

## 2. RACK PREPARATION

Before installing a node into a 19 inch rack, some precautions must be taken:

Precaution	Description
<b>Accessibility</b>	<p>The front must be easily accessible for carrying out the following tasks:</p> <ul style="list-style-type: none"><li>▶ connecting optical cables;</li><li>▶ connecting the PSU(s) cables;</li><li>▶ connecting interface modules;</li><li>▶ connecting HiProvision (=Dragon PTN Management System);</li><li>▶ system supervision (LED indications), tests and diagnostics;</li></ul> <p>The left side of the XT-1104-A, XT-2206-A, XT-2209-A and XT-2210-A node must be accessible for carrying out the following tasks:</p> <ul style="list-style-type: none"><li>▶ connecting the grounding cable; (see node forms for more details)</li></ul>
<b>Space</b>	<p>For a proper installation and ventilation of a Dragon PTN node(s), depending on the type, foresee the necessary space inside the rack. Provide at least 3 U free space above and below the node for heat dissipation (1 U = 1 HU = 1 RU = 44.45 mm / 1.75 inches).</p> <p>Install a 3 U blind panel above and below the Dragon PTN nodes. Stick the following label (supplied with node) on to the blind panels.</p> <ul style="list-style-type: none"><li>▶ XT-2210-A/XT-2209-A/ XT-2206-A / XT-1104-A Node: Height = 3 U</li></ul>
<b>Node Support Brackets</b>	<p>For a proper installation and support of the XT-2210-A/XT-2209-A node enclosure in a 19" frame, use 2 brackets or guides to support the node inside the rack (see example pictures).</p> <p> <b>Install the node support brackets always before you install the nodes inside the rack. When installing support brackets other than shown, please keep in mind that pass through panels can be installed and interference could occur.</b></p> <p></p>
<b>Identification</b>	<p>Be sure to identify all Dragon PTN and non-Dragon PTN equipment after installation. For a proper and reliable identification, use industrial labels. Identification can be done e.g. the IEC 61346-2 norm.</p> <ul style="list-style-type: none"><li>▶ Rack</li><li>▶ Dragon PTN node(s)</li></ul>

- 
- ▶ Cables
  - ▶ Main power
  - ▶ Other equipment
- 

### Grounding

For a proper grounding of the Dragon PTN node enclosure(s), a copper grounding bar must be installed inside the rack. Be sure to leave the 2 bottom grounding points free for connecting the earthing ground.



**Make sure that the integrity of protective earthing shall be ensured by connecting the Dragon PTN node enclosure(s) correctly to the grounding bar and connecting the grounding bar correctly to the ground.**

---

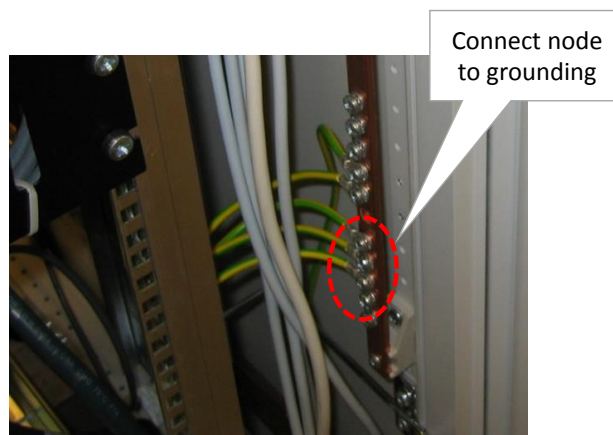

---

### Cable Distribution

For a proper cable(s) guidance throughout the rack, pass through panels and cable guides are preferred.



Example of a 1 U and 2 U pass through panel



Example of a cable guide

---

### Power Distribution

- ▶ Foresee the necessary power and plug-in inside the rack for a proper functioning of the Dragon PTN equipment;
  - ▶ Socket outlet shall be installed near the equipment and shall be easy accessible;
  - ▶ Clearly identify the circuit breakers used to secure the nodes against power disturbance.
-



Example of the labeling of a power box with circuit breakers and power sockets.

---

**Safety  
and  
Power Distribution**

▶ See Chapter 4.4

## **Nodes – Installation Forms**

### 3. NODES – INSTALLATION FORMS

#### 3.1 General

The Dragon PTN portfolio consists of 4 different node types: XT-2210-A, XT-2209-A, XT-2206-A and XT-1104-A. All nodes are modular and made of stainless steel (EN A2 1.4016). The XT-2210-A and XT-2209-A nodes are 19" Rack mountable (standard equipped). The XT-1104-A and XT-2206-A are 19" Rack mountable (accessories needed) or DIN Rail mountable (standard equipped). Depending on the installation needs an extra 19" mounting kit can be ordered.

The XT-1104-A or XT-2206-A node can also be equipped with a heavy duty DIN Rail kit that meets the standards IEC60255-21-1/2, IEEE1613 and IEC62498-3. This kit can be ordered additionally and will be pre-assembled at the Hirschmann facility.

See following table for order numbers of 19" mounting kits or Heavy duty DIN Rail kit:

Pictures of all these kits can be found in the node paragraphs further on.

Product	Order Number	Node Type
19" mounting kit for XT-2206-A	942 256-001	XT-2206-A
19" mounting kit for XT-1104-A	942 256-003	XT-1104-A
19" mounting kit for 2x XT-1104-A	942 256-004	XT-1104-A
Heavy duty DIN Rail kit for XT-2206-A	942 256-002	XT-2206-A
Heavy duty DIN Rail kit for XT-1104-A	942 256-005	XT-1104-A

Chassis XT-2210-A and XT-2209-A can be equipped with dual power supplies and dual Central Switching Modules for redundancy purposes. Chassis XT-1104-A is ultra-compact and can host a single power supply and one CSM. Node XT-2206-A is similar to node XT-2210-A/XT-2209-A but offers 6 interface slots instead of 10. All chassis are equipped with an NSM (= Node Support Module) which hosts common functions like I/O contacts and inputs for power over Ethernet (PoE) (PoE only on NSM-A).

#### 3.2 Power ON/OFF a Node or Switch

Once the PSUs have been installed later on, the node or switch can be powered ON or OFF.

- ▶ Power ON the node or switch: connect the PSU cable(s) to the PSU(s) and activate the necessary circuit breakers;
- ▶ Power OFF the node or switch: disconnect the PSU cable(s) from the PSU(s);

### 3.3 EMC Springs

All modules that can be plugged into a Dragon PTN node are provided with EMC springs for better EMC behavior. These springs can be found at the side of the front panel of each module.



Do not touch or bend these springs when unpacking the module, or inserting/removing it into/from the node. The example figure below shows the EMC springs on the CSM module.

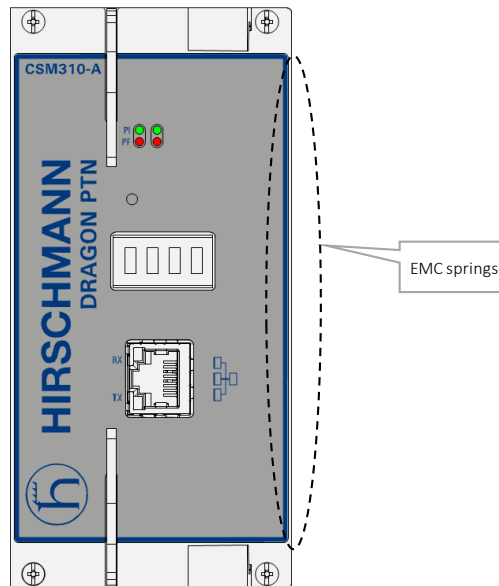

### 3.4 Card Guides inside the Node

Each module must be inserted later on into the node via sliding it through the correct card guides that can be found inside the node. Each slot has two top and two bottom card guides. Example: the figure below shows the CSM card guides.

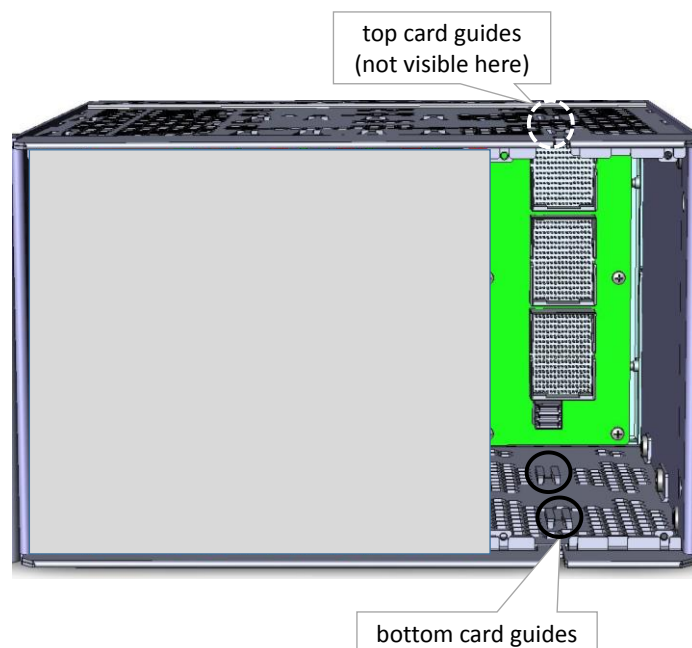



### 3.5 Node Module Positions

The node is modular meaning that modules can be plugged in. The positions of PSUs, Node Support Module (NSM), Central Switching Module (CSM) and interface modules (IFM) are shown in the table below per node type, as they are mentioned on the node backplane. This table also shows on a per system basis the modules that need to be installed in a node.

- 
- ▶ Before connecting the mains voltage and switching on the power, first connect the GND (Ground) to the housing of the node with a yellow/green cable of 6 mm<sup>2</sup>.
  - ▶ 1 U = 44.45 mm / 1.75 inches
  - ▶ When installing a node outside a rack, the necessary space must be available for a proper cooling of the node and the installation of fiber optic, interface cables and the earthing wire to the protective earth (PE).
  - ▶ When installing a Dragon PTN node, there must be at least 3 U free space below and above the node for ventilation.



**CAUTION:** Some parts of the node can be extremely hot. Therefore, it is strongly advised to use only the front panel handles of the module (NSM, CSM, IFM & PSU), and not touching the PCB or any other parts, when removing it from the node.



---

- ▶ It is also possible to install two XT-1104-A nodes next to each other within the rack. See also §3.6.
-

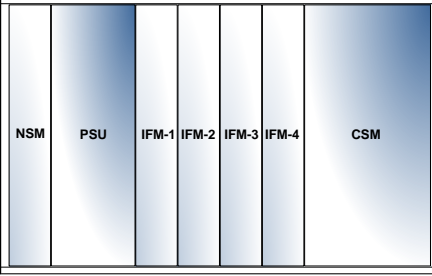
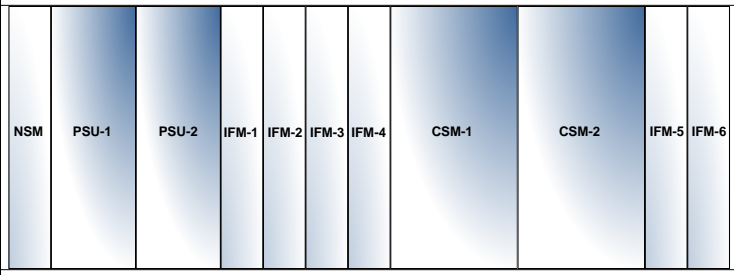
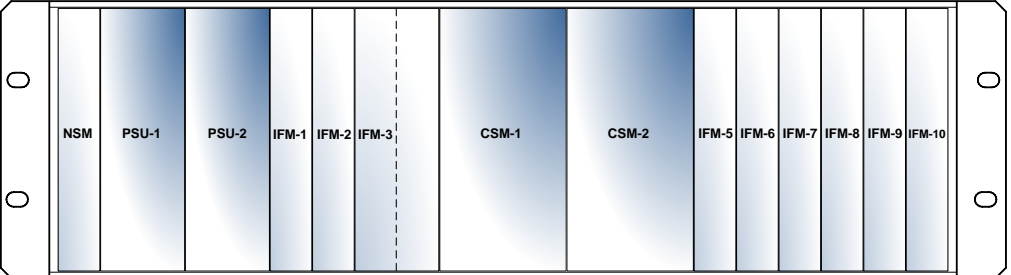
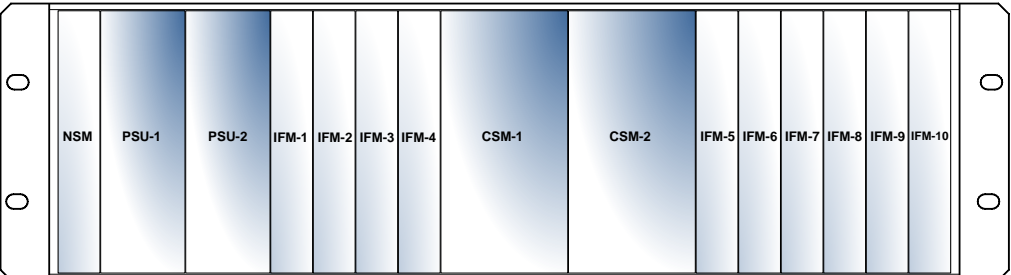
<b>Node type</b>	<b>Mounting System</b>	<b>Module Position</b>	<b>Module name</b>
<b>XT-1104-A (3 U)</b>	<b>19" Rack (1 or 2 nodes) Rack via DIN Rail</b>	NSM PSU IFM-1...IFM-4 CSM	Node Support Module Power supply unit 1 Interface module 1...4 Central Switching Module 1
<b>XT-2206-A (3 U)</b>	<b>19" Rack or DIN Rail</b>	NSM PSU-1 PSU-2 IFM-1...IFM-4 CSM-1 CSM-2 IFM-5, IFM-6	Node Support Module Power supply unit 1 Power supply unit 2 Interface module 1...4 Central Switching Module 1 Central Switching Module 2 Interface module 5 and 6
<b>XT-2209-A (3 U)</b>	<b>19" Rack or DIN Rail</b>	NSM PSU-1 PSU-2 IFM-1...IFM-3 CSM-1 CSM-2 IFM-5...IFM-10	Node Support Module Power supply unit 1 Power supply unit 2 Interface module 1...3 Central Switching Module 1 Central Switching Module 2 Interface module 5...10
<b>XT-2210-A (3 U)</b>	<b>19" Rack or DIN Rail</b>	NSM PSU-1 PSU-2 IFM-1...IFM-4 CSM-1 CSM-2 IFM-5...IFM-10	Node Support Module Power supply unit 1 Power supply unit 2 Interface module 1...4 Central Switching Module 1 Central Switching Module 2 Interface module 5...10

Node Type	Visual Module Position
<p><b>XT-1104-A</b></p>	 <p>The diagram shows a horizontal row of seven modules. From left to right, they are labeled: NSM, PSU, IFM-1, IFM-2, IFM-3, IFM-4, and CSM. The PSU and CSM modules are shaded blue.</p>
<p><b>XT-2206-A</b></p>	 <p>The diagram shows a horizontal row of eleven modules. From left to right, they are labeled: NSM, PSU-1, PSU-2, IFM-1, IFM-2, IFM-3, IFM-4, CSM-1, CSM-2, IFM-5, and IFM-6. The PSU-1, PSU-2, CSM-1, and CSM-2 modules are shaded blue.</p>
<p><b>XT-2209-A</b></p>	 <p>The diagram shows a horizontal row of fourteen modules. From left to right, they are labeled: NSM, PSU-1, PSU-2, IFM-1, IFM-2, IFM-3, CSM-1, CSM-2, IFM-5, IFM-6, IFM-7, IFM-8, IFM-9, and IFM-10. A vertical dashed line is positioned between IFM-3 and CSM-1. The PSU-1, PSU-2, CSM-1, and CSM-2 modules are shaded blue. There are four circular mounting holes on each side of the node.</p>
<p><b>XT-2210-A</b></p>	 <p>The diagram shows a horizontal row of fourteen modules. From left to right, they are labeled: NSM, PSU-1, PSU-2, IFM-1, IFM-2, IFM-3, IFM-4, CSM-1, CSM-2, IFM-5, IFM-6, IFM-7, IFM-8, IFM-9, and IFM-10. The PSU-1, PSU-2, CSM-1, and CSM-2 modules are shaded blue. There are four circular mounting holes on each side of the node.</p>

### 3.6 XT-1104-A Node (942 228-001)

Engineer type	Section	Form: Installation of an XT-1104-A Node
 <p>Duration: 30 min.</p>	ESD	<p>With all installation activities, adopt the ESD recommendations regarding the handling, transportation and storage of modules. Find a full ESD description in chapter 18.</p> <p><b>Always wear an antistatic wristband in direct contact with your skin. Connect the alligator clip to the blank metal of the rack or plug the antistatic wristband into the ESD bonding point.</b></p> 
<b>Installation Equipment</b>		<ul style="list-style-type: none"> <li>▶ Key of the rack (if necessary)</li> <li>▶ Screwdriver set, screws, cage nuts, cable ties and cable tool set</li> <li>▶ Antistatic wristband</li> <li>▶ XT-1104-A node + additional support brackets + earthing wire 6 mm<sup>2</sup></li> <li>▶ Extra documentation can be found in chapter 15</li> </ul>
<b>Node Specifications</b>	<b>Dimensions:</b>	<ul style="list-style-type: none"> <li>▶ Width 211 mm / 8.31 inches</li> <li>▶ Height (3 U) 132.5 mm / 5.22 inches</li> <li>▶ Depth 220 mm / 8.66 inches</li> </ul> <p><b>Weight:</b></p> <ul style="list-style-type: none"> <li>▶ Approx. 2 kg / 4.4 lb without heavy duty Din Rail kit</li> <li>▶ Approx. 3 kg / 6.6 lb with heavy duty Din Rail kit</li> </ul>
<b>Node Build up</b>		<ul style="list-style-type: none"> <li>▶ NSM: position of the Node Support Module</li> <li>▶ PSU: position of the power supply</li> <li>▶ IFM-1...IFM-4: position of the interface modules</li> <li>▶ CSM: position of the Central Switching Module</li> </ul>
<b>Rack Installation on Wall Mount DIN Rail</b>		<ol style="list-style-type: none"> <li>1. Remove the packaging from the new node.</li> <li>2. Identify where the node has to be installed: inside or outside the rack. If inside a rack, foresee a DIN RAIL inside the rack to attach the node with or without heavy duty DIN Rail kit.</li> <li>3. Insert the node into the rack and attach it to the DIN Rail on the back wall, check if the node is properly fixed to the DIN rail. With a normal 'DIN Rail Kit', use the bracket (push down and release) on the back of the node to lock the node properly to the DIN rail. With a Heavy Duty 'DIN Rail Kit', use the bracket (pull down and release) on the back of the node to lock the node properly to the DIN rail. Attach the fixation clips, left and right of the node, to the DIN rail and use the screws to hold the clips in line. See pictures below.</li> </ol>



**Do not install any other equipment directly above/under the node for ventilation reasons. Above and below the node, sufficient space (3 U) must be provided to guarantee a free air flow.**

4. Connect an earthing wire (yellow – green) 6 mm<sup>2</sup> to the cable socket of the XT-1104-A node, see pictures below. Connect the other end of the earthing wire to the grounding copper bar of the rack.
5. Make sure that the front is easily accessible to connect the cables and supervision later on.

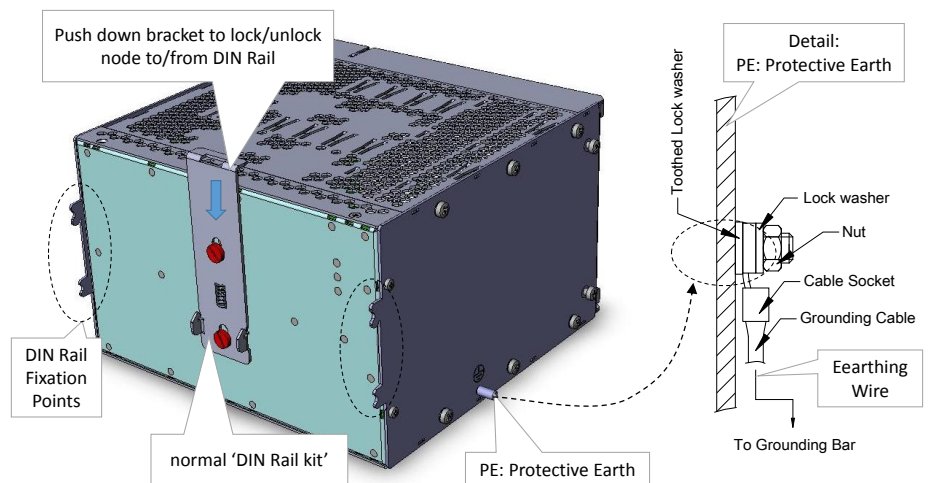

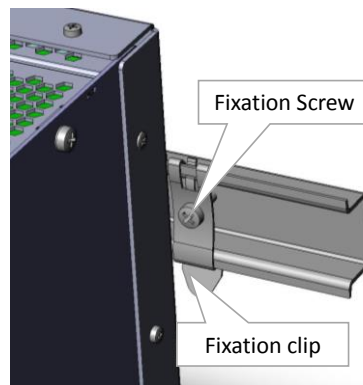
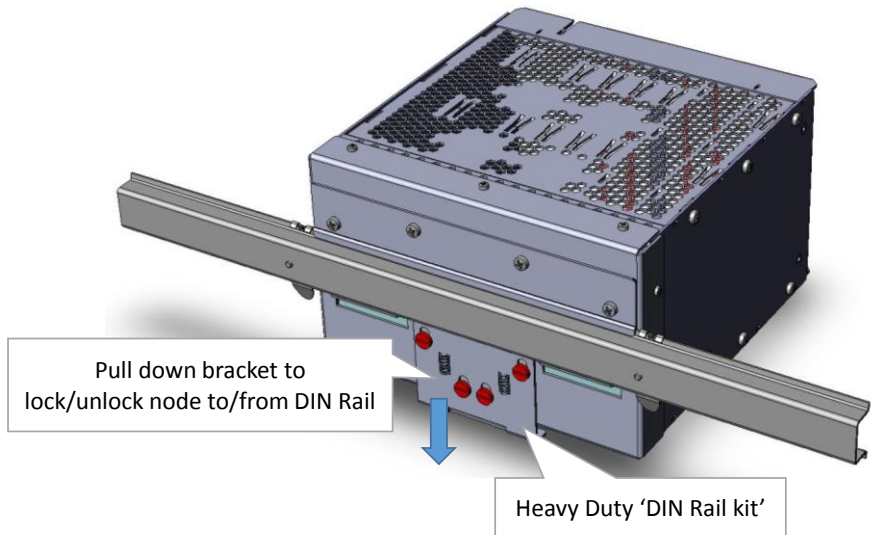

**19" Rack  
Installation  
of a single  
node**

1. Remove the packaging from the new node and 19" mounting kit.
2. Assemble the two 19" brackets to the node as shown in the picture below. Use the supplied screws to fix the brackets to the node. (both brackets can be assembled either left or right of the node)

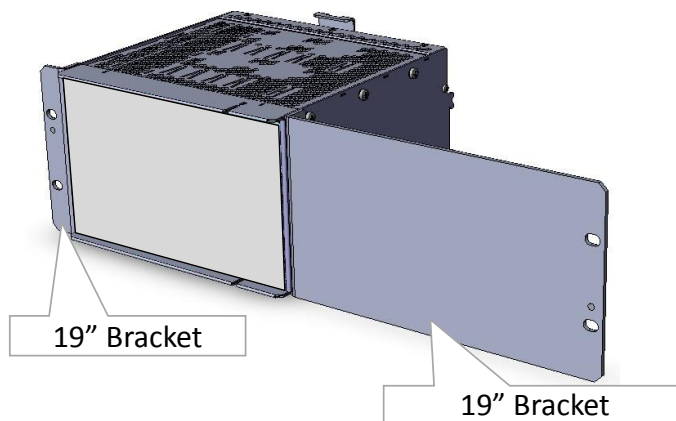

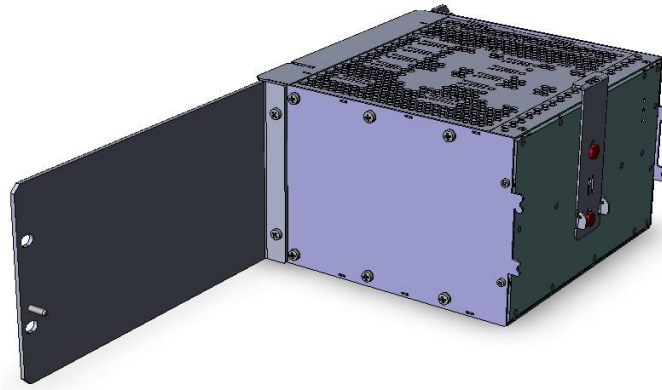

3. Identify where the node has to be installed inside the rack. Attach 4 cage nuts on the back of the vertical support rails in line with the node fixing points.
4. Insert the node into the rack, check if the node rests on the support brackets (see chapter 2) and use 4 screws to tighten the node to the vertical support rails.



**Do not install any other equipment directly above/under the node for ventilation reasons. Above and below the node, sufficient space (3 U) must be provided to guarantee a free air flow.**

---

5. Connect an earthing wire (yellow – green) 6 mm<sup>2</sup> to the cable socket of the XT-1104-A node, see picture below. Connect the other end of the earthing wire to the grounding copper bar of the rack.
6. Make sure that the front is easily accessible to connect the cables and supervision later on.

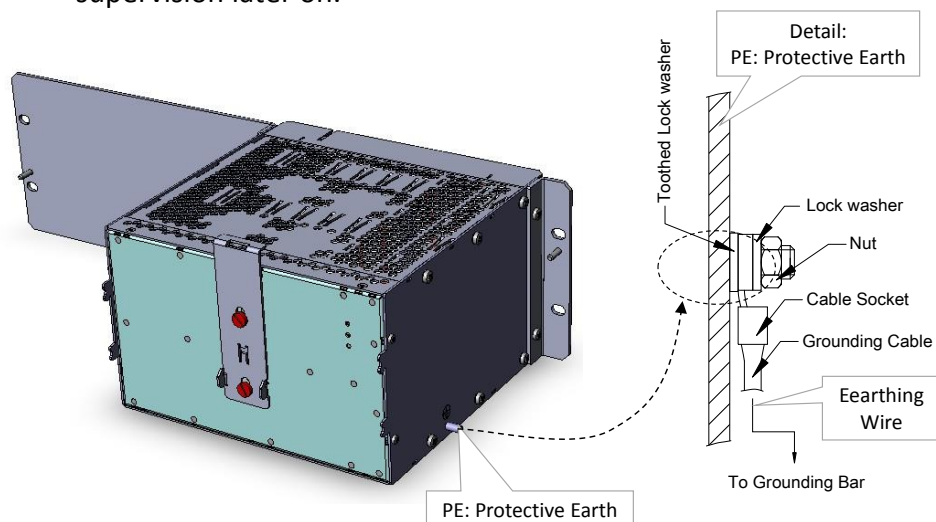

---

**19" Rack  
Installation  
of 2 nodes**

1. Remove the packaging from the new nodes and 19" mounting kit.
2. Assemble one 19" bracket on the left-hand side of the 1<sup>st</sup> node and the other 19" bracket on the right-hand side of the 2<sup>nd</sup> node. Assemble and fix the interconnection brackets between the two nodes. Use the supplied screws to fix the brackets to the nodes.

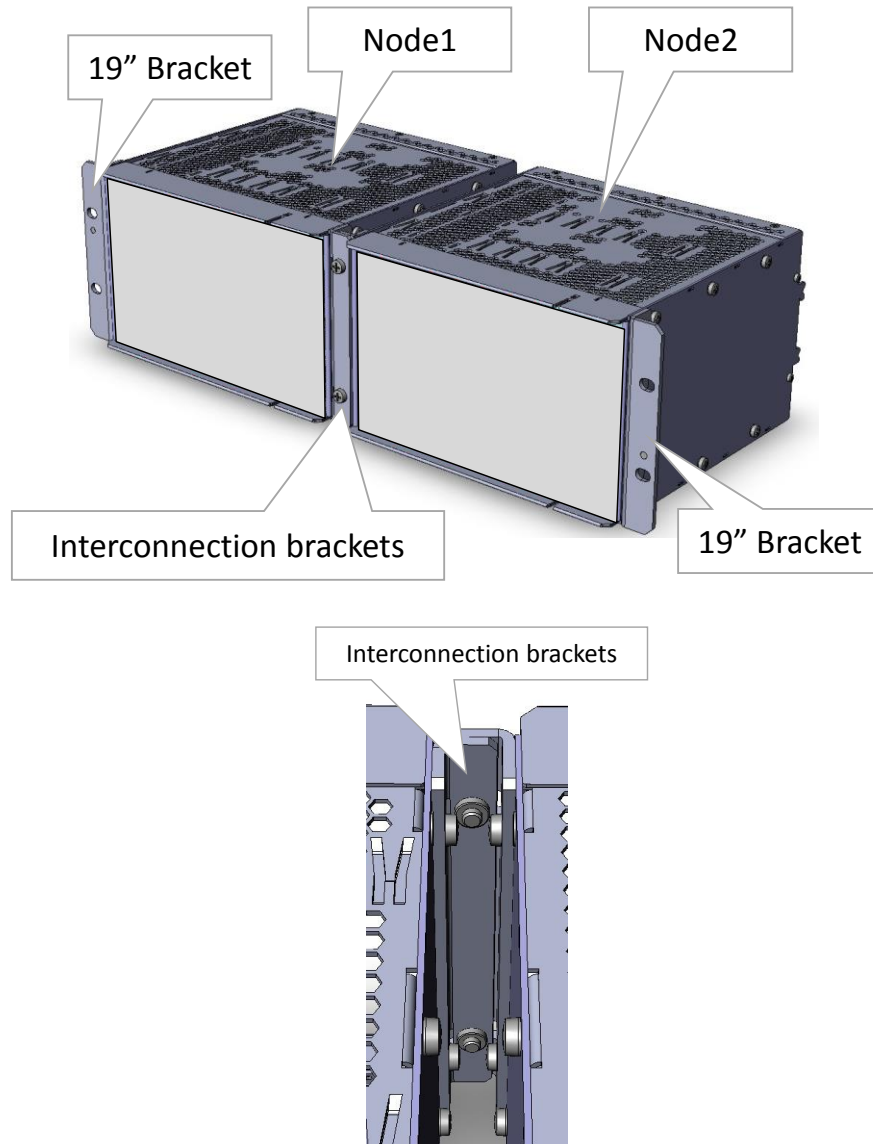

3. Identify where the node has to be installed inside the rack. Attach 4 cage nuts on the back of the vertical support rails in line with the node fixing points.
4. Insert the node into the rack, check if the node rests on the support brackets (see chapter 2) and use 4 screws to tighten the node to the vertical support rails.



**Do not install any other equipment directly above/under the node for ventilation reasons. Above and below the node, sufficient space (3 U) must be provided to guarantee a free air flow.**



---

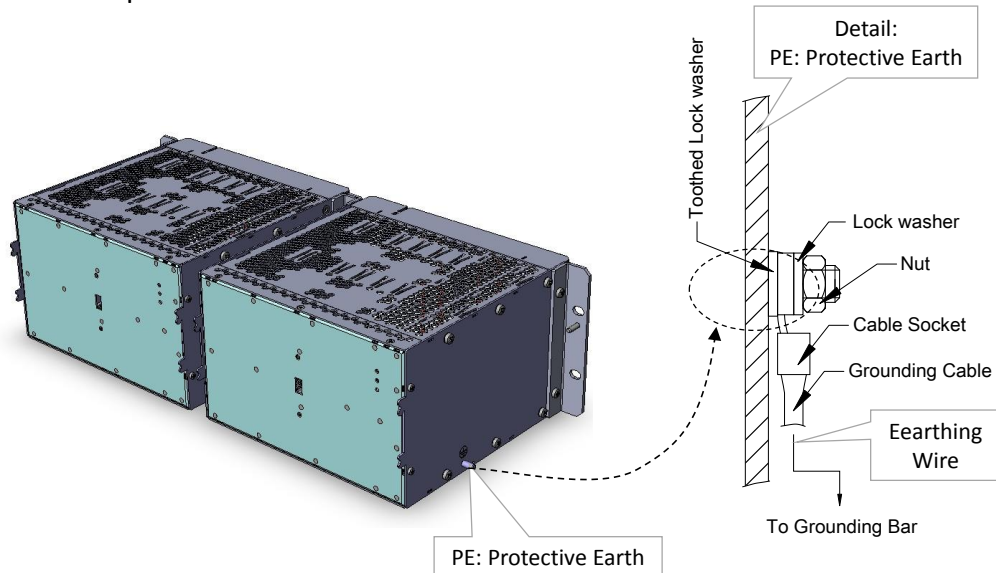

- 
5. Connect an earthing wire (yellow – green) 6 mm<sup>2</sup> to the cable socket of the left XT-1104-A node, see picture below. Connect the other end of the earthing wire to the grounding copper bar of the rack.
  6. Make sure that the front is easily accessible to connect the cables and supervision later on.



### 3.7 XT-2206-A Node (942 228-002)

Engineer type	Section	Form: Installation of an XT-2206-A Node
 <p>Duration: 30 min.</p>	ESD	<p>With all installation activities, adopt the ESD recommendations regarding the handling, transportation and storage of modules. Find a full ESD description in chapter 18.</p> <div style="display: flex; align-items: center;">  <p><i>Always wear an antistatic wristband in direct contact with your skin. Connect the alligator clip to the blank metal of the rack or plug the antistatic wristband into the ESD bonding point.</i></p> </div>
	<b>Installation Equipment</b>	<ul style="list-style-type: none"> <li>▶ Key of the rack (if necessary)</li> <li>▶ Screwdriver set, screws, cage nuts, cable ties and cable tool set</li> <li>▶ Antistatic wristband</li> <li>▶ XT-2206-A node + additional support brackets + earthing wire 6 mm<sup>2</sup></li> <li>▶ Extra documentation can be found in chapter 15</li> </ul>
	<b>Node Specifications</b>	<p><b>Dimensions:</b></p> <ul style="list-style-type: none"> <li>▶ Width                    353.5 mm / 13.92 inches</li> <li>▶ Height (3 U)            132.5 mm / 5.22 inches</li> <li>▶ Depth                    220 mm / 8.66 inches</li> </ul> <p><b>Weight:</b></p> <ul style="list-style-type: none"> <li>▶ Approx. 3 kg / 6.6 lb without heavy duty Din Rail kit</li> <li>▶ Approx. 4 kg / 8.8 lb with heavy duty Din Rail kit</li> </ul>
	<b>Node Build up</b>	<ul style="list-style-type: none"> <li>▶ NSM: position of the Node Support Module</li> <li>▶ PSU-1/PSU-2: position of the power supplies</li> <li>▶ IFM-1...IFM-6: position of the interface modules</li> <li>▶ CSM-1/CSM-2: position of the Central Switching Module</li> </ul>
	<b>Rack Installation on Wall Mount DIN Rail</b>	<ol style="list-style-type: none"> <li>1. Remove the packaging from the new node.</li> <li>2. Identify where the node has to be installed: inside or outside the rack. If inside a rack, foresee a DIN RAIL inside the rack to attach the node with or without heavy duty DIN Rail kit.</li> <li>3. Insert the node into the rack and attach it to the DIN Rail on the back wall, check if the node is properly fixed to the DIN rail. With a normal 'DIN Rail Kit', use the bracket (push down and release) on the back of the node to lock the node properly to the DIN rail. With a Heavy Duty 'DIN Rail Kit', use the bracket (pull down and release) on the back of the node to lock the node properly to the DIN rail. Attach the fixation clips, left and right of the node, to the DIN rail and use the screws to hold the clips in line. See pictures below.</li> </ol>



**Do not install any other equipment directly above/under the node for ventilation reasons. Above and below the node, sufficient space (3 U) must be provided to guarantee a free air flow.**

4. Connect an earthing wire (yellow – green) 6 mm<sup>2</sup> to the cable socket of the XT-2206-A node, see pictures below. Connect the other end of the earthing wire to the grounding copper bar of the rack.
5. Make sure that the front is easily accessible to connect the cables and supervision later on.

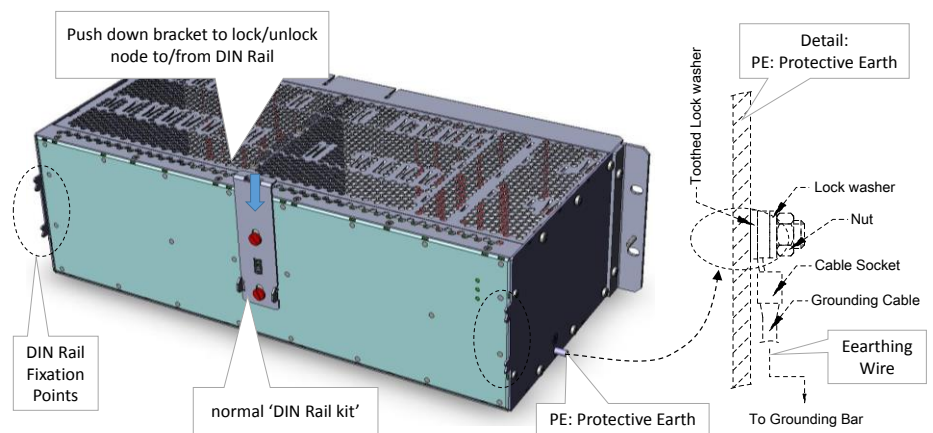

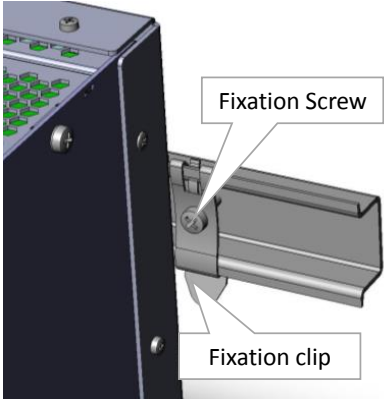
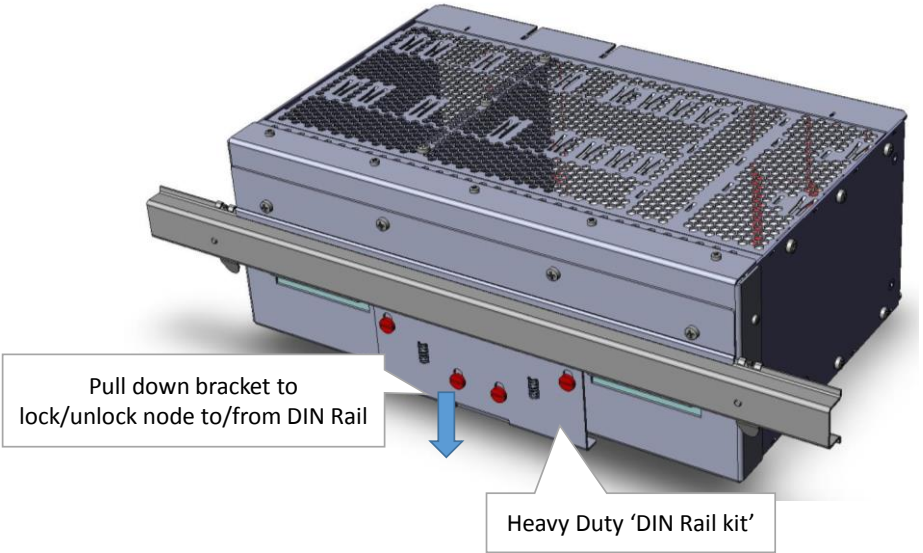

---

## 19" Rack Installation

1. Remove the packaging from the new node and 19" installation kit. Assemble the two 19" brackets to the node as shown in picture below. Use the supplied screws to fix the brackets to the node. (both brackets can be assembled either left or right of the node)

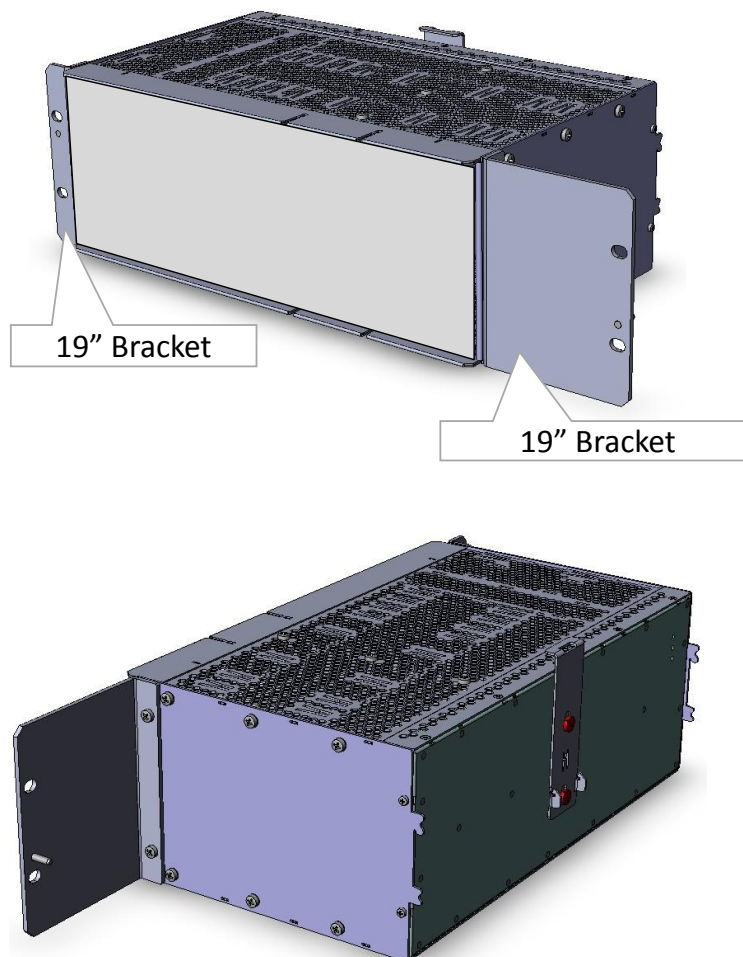

2. Use the supplied screws to fix the brackets to the node. (both brackets can be assembled on both sides of the node)
3. Identify where the node has to be installed inside the rack. Attach 4 cage nuts on the back of the vertical support rails in line with the node fixing points.
4. Insert the node into the rack, check if the node rests on the support brackets (see chapter 2) and use 4 screws to tighten the node to the vertical support rails.



**Do not install any other equipment directly above/under the node for ventilation reasons. Above and below the node, sufficient space (3 U) must be provided to guarantee a free air flow.**



---

5. Connect an earthing wire (yellow – green) 6 mm<sup>2</sup> to the cable socket of the XT-2206-A node, see picture below. Connect the other end of the earthing wire to the grounding copper bar of the rack.
-

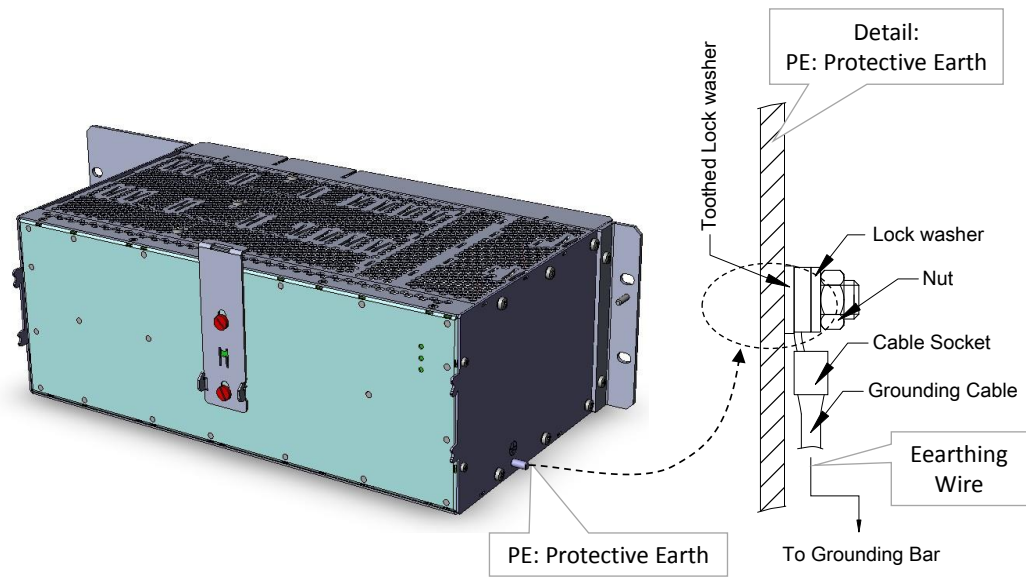
- 
6. Make sure that the front is easily accessible to connect the cables and supervision later on.



### 3.8 XT-2209-A Node (942 228-003)

Engineer type	Section	Form: Installation of an XT-2209-A Node
 <p>Duration: 30 min.</p>	<p><b>ESD</b></p>	<p>With all installation activities, adopt the ESD recommendations regarding the handling, transportation and storage of modules. Find a full ESD description in chapter 18.</p> <div style="display: flex; align-items: center;">  <p><i>Always wear an antistatic wristband in direct contact with your skin. Connect the alligator clip to the blank metal of the rack or plug the antistatic wristband into the ESD bonding point.</i></p> </div>
	<p><b>Installation Equipment</b></p>	<ul style="list-style-type: none"> <li>▶ Key of the rack (if necessary)</li> <li>▶ Screwdriver set, screws, cage nuts, cable ties and cable tool set</li> <li>▶ Antistatic wristband</li> <li>▶ XT-2209-A node + additional support brackets + earthing wire 6 mm<sup>2</sup></li> <li>▶ Extra documentation can be found in chapter 15</li> </ul>
	<p><b>Node Specifications</b></p>	<p><b>Dimensions:</b></p> <ul style="list-style-type: none"> <li>▶ Width                    482 mm / 18.98 inches</li> <li>▶ Height (3 U)            132.5 mm / 5.22 inches</li> <li>▶ Depth                    220 mm / 8.66 inches</li> </ul> <p><b>Weight:</b></p> <ul style="list-style-type: none"> <li>▶ Approx.                 3.5 kg / 7.7 lb</li> </ul>
	<p><b>Node Build up</b></p>	<ul style="list-style-type: none"> <li>▶ NSM: position of the Node Support Module</li> <li>▶ PSU-1/PSU-2: position of the power supplies</li> <li>▶ IFM-1...IFM3 and IFM5...IFM-10: position of the interface modules</li> <li>▶ CSM-1/CSM-2: position of the Central Switching Module</li> </ul>
	<p><b>Rack Installation 19 inch Rack</b></p>	<ol style="list-style-type: none"> <li>1. Remove the packaging from the new node.</li> <li>2. Identify where the node has to be installed: inside or outside the rack. If inside a rack, attach 4 cage nuts on the back of the vertical support rails in line with the node fixing points.</li> </ol>
<div style="display: flex; align-items: center; justify-content: center;">  <p><b>Do not install any other equipment directly above/under the node for ventilation reasons. Above and below the node, sufficient space (3 U) must be provided to guarantee a free air flow.</b></p> </div>		
<ol style="list-style-type: none"> <li>3. Insert the node into the rack, check if the node rests on the support brackets (see chapter 2) and use 4 screws to tighten the node to the vertical support rails.</li> <li>4. Connect an earthing wire (yellow – green) 6 mm<sup>2</sup> to the cable socket of the XT-2209-A node, see pictures below. Connect the other end of the earthing wire to the grounding copper bar of the rack.</li> </ol>		



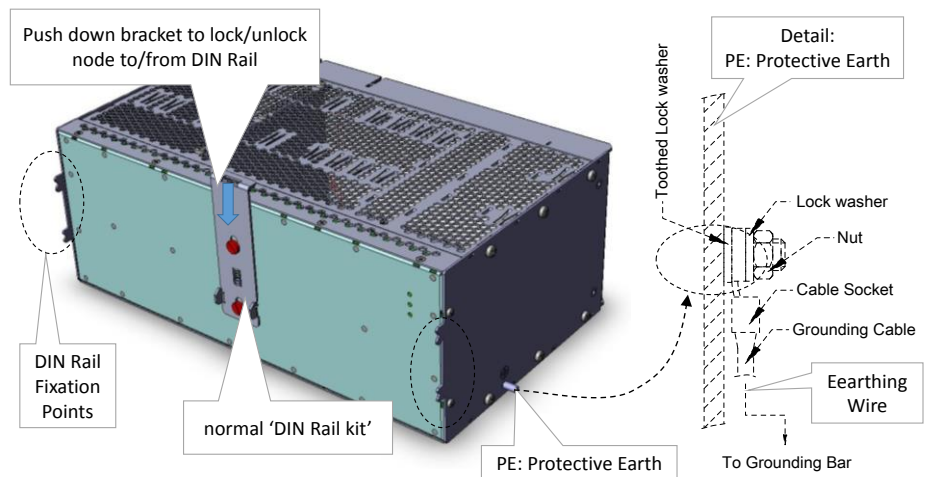

It is possible to install the XT-2209-A on a DIN rail but it is not recommended due to the substantial weight of the node.





### 3.9 XT-2210-A Node (942 228-004)

Engineer type	Section	Form: Installation of an XT-2210-A Node
 <p>Duration: 30 min.</p>	<p><b>ESD</b></p>	<p>With all installation activities, adopt the ESD recommendations regarding the handling, transportation and storage of modules. Find a full ESD description in chapter 18.</p> <div style="display: flex; align-items: center;">  <div style="margin-left: 10px;"> <p><i>Always wear an antistatic wristband in direct contact with your skin. Connect the alligator clip to the blank metal of the rack or plug the antistatic wristband into the ESD bonding point.</i></p> </div> </div>
	<p><b>Installation Equipment</b></p>	<ul style="list-style-type: none"> <li>▶ Key of the rack (if necessary)</li> <li>▶ Screwdriver set, screws, cage nuts, cable ties and cable tool set</li> <li>▶ Antistatic wristband</li> <li>▶ XT-2210-A node + additional support brackets + earthing wire 6 mm<sup>2</sup></li> <li>▶ Extra documentation can be found in chapter 15</li> </ul>
	<p><b>Node Specifications</b></p>	<p><b>Dimensions:</b></p> <ul style="list-style-type: none"> <li>▶ Width                    482 mm / 18.98 inches</li> <li>▶ Height (3 U)        132.5 mm / 5.22 inches</li> <li>▶ Depth                    220 mm / 8.66 inches</li> </ul> <p><b>Weight:</b></p> <ul style="list-style-type: none"> <li>▶ Approx.                3.5 kg / 7.7 lb</li> </ul>
	<p><b>Node Build up</b></p>	<ul style="list-style-type: none"> <li>▶ NSM: position of the Node Support Module</li> <li>▶ PSU-1/PSU-2: position of the power supplies</li> <li>▶ IFM-1...IFM-10: position of the interface modules</li> <li>▶ CSM-1/CSM-2: position of the Central Switching Module</li> </ul>
	<p><b>Rack Installation 19 inch Rack</b></p>	<ol style="list-style-type: none"> <li>1. Remove the packaging from the new node.</li> <li>2. Identify where the node has to be installed: inside or outside the rack. If inside a rack, attach 4 cage nuts on the back of the vertical support rails in line with the node fixing points.</li> </ol>
		<div style="border: 1px solid black; padding: 5px; margin-bottom: 10px;">  <p><b>Do not install any other equipment directly above/under the node for ventilation reasons. Above and below the node, sufficient space (3 U) must be provided to guarantee a free air flow.</b></p> </div> <ol style="list-style-type: none"> <li>3. Insert the node into the rack, check if the node rests on the support brackets (see chapter 2) and use 4 screws to tighten the node to the vertical support rails.</li> <li>4. Connect an earthing wire (yellow – green) 6 mm<sup>2</sup> to the cable socket of the XT-2210-A node, see pictures below. Connect the other end of the earthing wire to the grounding copper bar of the rack.</li> </ol>



It is possible to install the XT-2210-A on a DIN rail but it is not recommended due to the substantial weight of the node.

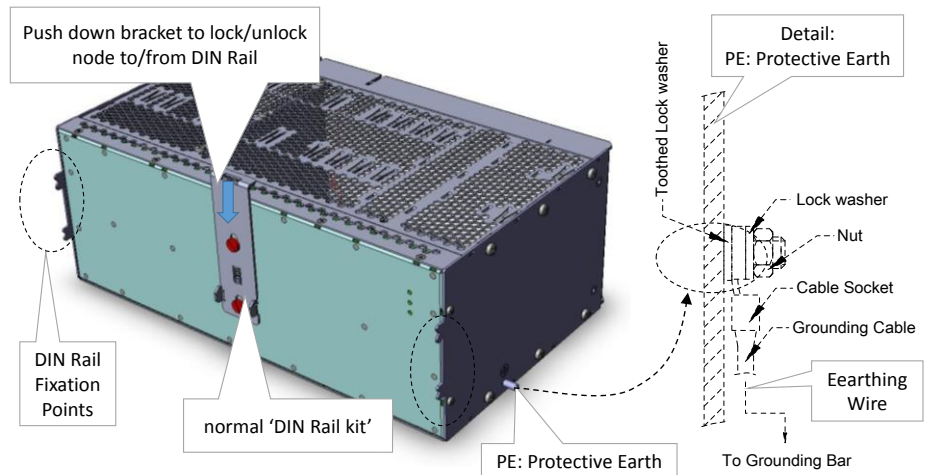

## **Power Supplies – Installation Forms**

## 4. POWER SUPPLIES – INSTALLATION FORMS

### 4.1 PSU Types for Dragon PTN Nodes

The XT-2210-A/XT-2209-A/XT-2206-A node can be equipped with two power supplies. The XT-1104-A can only be equipped with one power supply. PSU-1 and/or PSU-2 convert the mains or battery input voltages to 12 VDC for the operating voltages of the node. The Node Support Module (=NSM, see chapter 5) has LEDs for input and output voltage indications. A green lit PSI/PSO LED indicates that input/output voltage is present. The PSUs are redundant, hot swappable with current sharing.

The XT-2210-A/XT-2209-A/XT-2206-A nodes can operate with one or two power supplies in any of the positions. Without redundant power supply, cover **the empty PSU position with a PSU cover plate**. For corresponding order numbers, see table below.

The NSM-A has 2 PoE connectors on the front panel to connect 2 external PoE sources. An external DIN rail PoE PSU could be used for this purpose. When using the ACPoE-A or DCPoE-A PSU below, the DC output power is factory set to 56V output voltage. For a connection example of this PSU to the NSM, see §5.1.

Product	Order Number
AC PSU (ACP-A): 100-240 VAC ±10 %	942 234-001
DC PSU (DCP-A): 18-60 VDC	942 234-002
DC PSU (DCP-B): 88-300 VDC	942 234-003
ACPoE-A External DIN rail PoE AC/DC PSU (=AC 100-240VAC Wide-range Input)	942 235-001
DCPoE-A External DIN rail PoE DC/DC PSU (=DC 48VDC Input)	942 235-002
PSU Cover Plate	942 237-002

## 4.2 PSU Cables

The power supplies are connected via PSU cables via the node front.

**AC PSU Cables:** For the 100-240 VAC power supplies, the mains power cord with self-locking must be plugged in. Make sure that the cable is locked on the connector. See table below for an overview of the order numbers.

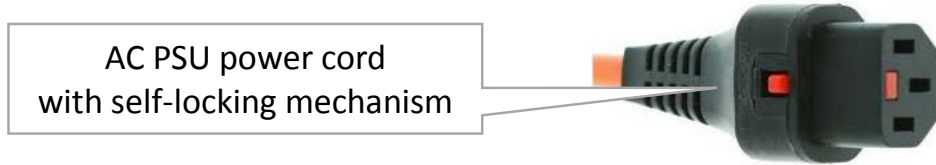

**DC PSUs Cables:** For the 18-60 VDC and 88-300 VDC PSU, the voltage wires must be connected to the feed through connectors provided on the PSU front. The DC power supplies/cables have a coding profile or code keys to prevent that a wrong cable and voltage is plugged into the PSU, see further on for more information. See table below for an overview of the order numbers.

**PoE PSU Cable:** Cable needed to connect the external PoE PSU to the NSM-A. See table below for the order number.

Product	Order Number
Europe: AC PSU cable with IEC lock (2.5m) for AC PSU 100 to 240 VAC $\pm$ 10 %	942 256-100
UK: AC PSU cable with IEC lock (2.5m) for AC PSU 100 to 240 VAC $\pm$ 10 %	942 256-101
US: AC PSU cable with IEC lock (2.5m) for AC PSU 100 to 240 VAC $\pm$ 10 %	942 256-102
DC PSU 3G x 2.5mm <sup>2</sup> unshielded cable (3m) with coding keys for DC PSU 18 to 60 VDC	942 256-103
DC PSU 3G x 2.5mm <sup>2</sup> unshielded cable (3m) with coding keys for DC PSU 88 to 300 VDC	942 256-104
Cable (3m) to connect External DIN rail PoE PSU to the NSM-A	942 256-105

- ▶ **CAUTION: DOUBLE POLE / NEUTRAL FUSING**
- ▶ When using redundant PSUs, the node will only become powerless after disconnecting both PSUs.
- ▶ After operation of one fuse, parts of the equipment remain energized.
- ▶ Cover all empty PSU positions with the appropriate cover plate (see above table for corresponding cover plate). Fix the cover plates of a disassembled node before powering up the node.
- ▶ Never apply any excess voltage and always respect the correct polarity for DC power supplies. Not observing this rule may damage the nodes. With long distances, check the voltage loss due to copper losses of the power supply cable.
- ▶ Switch off the power and disconnect the power cable before opening or removing the PSU.
- ▶ We advise to protect each PSU and/or power strip with an appropriate circuit breaker. Depending on the voltage value and type (AC or DC) of the PSU a corresponding circuit breaker must be chosen. See following table



Input Voltage	Circuit Breaker Value
18VDC	16A for DC current
60VDC	4A for DC current
88VDC	4A for DC current
300VDC	2A for DC current
100VAC	3A or 4A for AC current
220VAC	2A for AC current

- ▶ Always use the front panel handles to plug in/remove a PSU into/from a node. Do not touch or bend the EMC spring on the side of the front panel.



**CAUTION:** Some parts of the node can be extremely hot. Therefore, it is strongly advised to use only the front panel handles of the module (NSM, CSM, IFM & PSU), and not touching the PCB or any other parts, when removing it from the node.

### 4.3 IT Grounding System



A Dragon PTN node can be connected to an IT grounding system (standard EN60950-1) (see picture below).

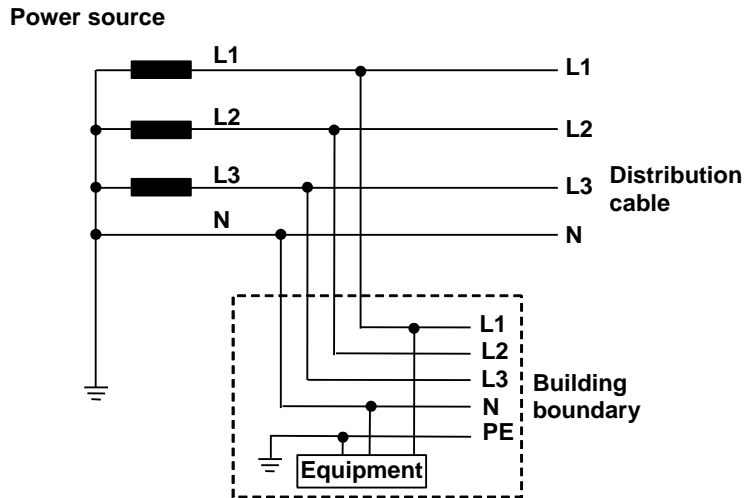

Separate Neutral and Protective Conductors

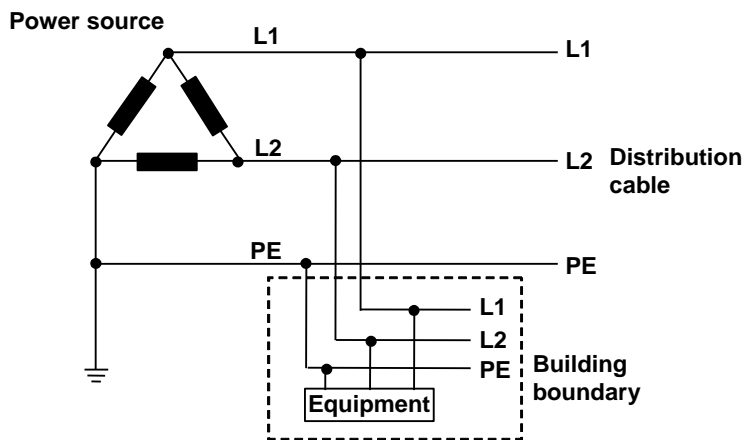

Earthed Line Conductor

### 4.4 Safety and Power Distribution



- ▶ When connecting the Dragon PTN PSU directly to a circuit breaker, be sure to use bootlace ferrules.
- ▶ A maximum of 2 PSUs can be connected to one circuit breaker.
- ▶ Use copper bridges to interconnect the circuit breakers.
- ▶ Earthing wires that are used as a pass through connected must be at least 2.5 mm<sup>2</sup>.
- ▶ It is advised to protect the main power with an appropriate earth leakage circuit breaker.

## 4.5 ACP-A: 100-240 VAC ± 10 % - PSU (942 234-001)

Engineer type	Section	Form: Installation of an 100-240 VAC PSU
---------------	---------	--



### ESD

With all installation activities, adopt the ESD recommendations regarding the handling, transportation and storage of modules. Find a full ESD description in chapter 18.

Duration:  
15 min.



*Always wear an antistatic wristband in direct contact with your skin. Connect the alligator clip to the blank metal of the rack or plug the antistatic wristband into the ESD bonding point.*

### Installation Equipment

- ▶ Key of the rack (if necessary)
- ▶ Screwdriver set, cable ties and cable tool set
- ▶ Antistatic wristband
- ▶ 100-240 VAC PSU + Power cord with locking mechanism
- ▶ Extra documentation can be found in chapter 15

### Front Panel and Power Cable

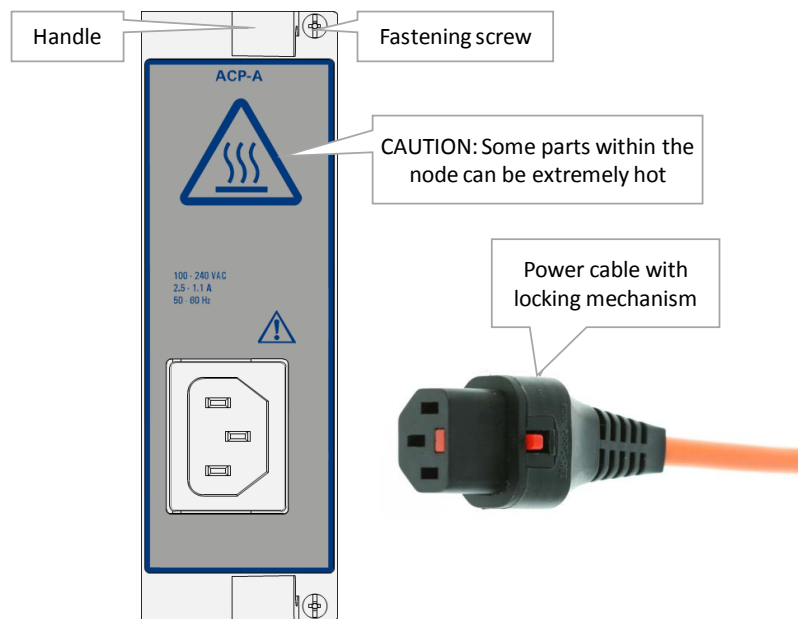

### Installation

1. Take the 100-240 VAC PSU out of the antistatic bag.
2. Slide the PSU in the allocated slot of the node (see corresponding Node form).
3. **VERY IMPORTANT:** Tighten the PSU with the two fastening screws for optimal contact.
4. Connect the power distribution to the PSU via the power cord and push until the connector is locked.
5. Label the power cord(s).
6. If necessary, the node can be powered on as described in §3.2.



## 4.6 DCP-A: 18-60 VDC PSU (942 234-002)

Engineer type	Section	Form: Installation of an 18-60 VDC PSU
---------------	---------	--



### ESD

With all installation activities, adopt the ESD recommendations regarding the handling, transportation and storage of modules. Find a full ESD description in chapter 18.

Duration:  
15 min.



**Always wear an antistatic wristband in direct contact with your skin. Connect the alligator clip to the blank metal of the rack or plug the antistatic wristband into the ESD bonding point.**

- Installation Equipment**
- ▶ Key of the rack (if necessary)
  - ▶ Screwdriver set, cable ties and cable tool set
  - ▶ Antistatic wristband
  - ▶ 18-60 VDC PSU + Power cord (if not pre-installed)
  - ▶ Extra documentation can be found in chapter 15

### Front Panel And Power Cable

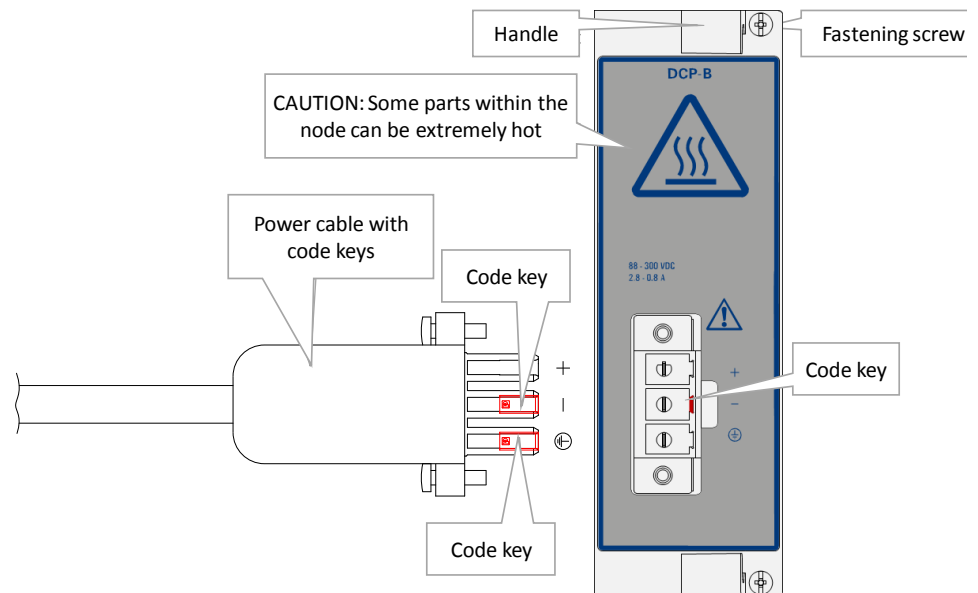

Pin	PSU Side	Cable Side
+	Code Key	
-		Code Key
⊕ (PE)		Code Key

- Installation**
1. Take the 18-60 VDC PSU out of the antistatic bag.
  2. Slide the PSU in the allocated slot of the node (see corresponding Node form).
  3. **VERY IMPORTANT:** Tighten the PSU with the two fastening screws for optimal contact.



The DC power supplies/cables have a coding profile or code keys to prevent plugging in a wrong cable and voltage into the PSU.

---

4. Connect the power distribution via the power cord to the PSU and tighten the 2 screws for locking the power cord.
  5. Label the power cord(s).
  6. If necessary, the node can be powered on as described in §3.2.
-

## 4.7 DCP-B: 88-300 VDC PSU (942 234-003)

Engineer type	Section	Form: Installation of an 88-300 VDC PSU
---------------	---------	---



### ESD

With all installation activities, adopt the ESD recommendations regarding the handling, transportation and storage of modules. Find a full ESD description in chapter 18.

Duration:  
15 min.



*Always wear an antistatic wristband in direct contact with your skin. Connect the alligator clip to the blank metal of the rack or plug the antistatic wristband into the ESD bonding point.*

- Installation Equipment**
- ▶ Key of the rack (if necessary)
  - ▶ Screwdriver set, cable ties and cable tool set
  - ▶ Antistatic wristband
  - ▶ 88-300 VDC PSU + Power cord (if not pre-installed)
  - ▶ Extra documentation can be found in chapter 15

### Front Panel And Power Cable

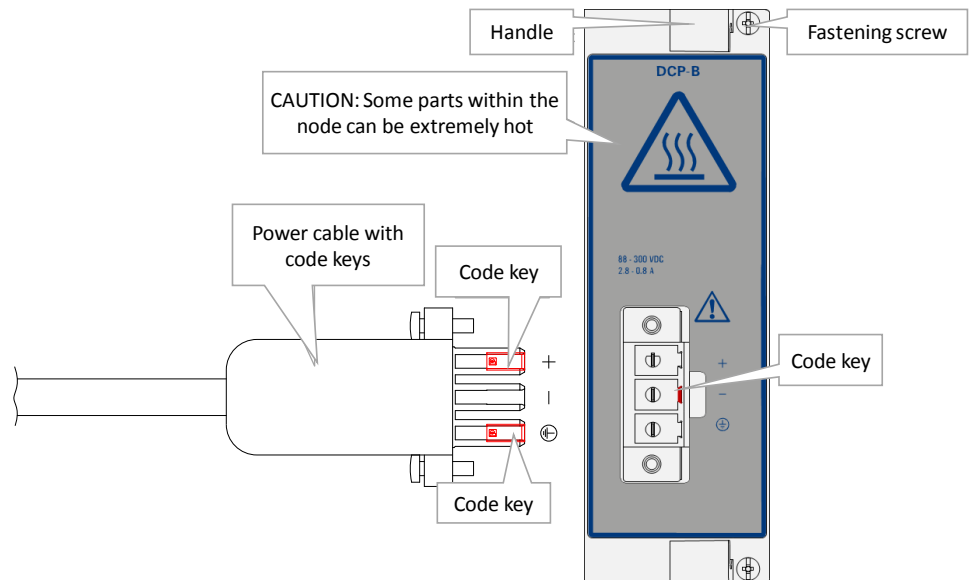

Pin	PSU Side	Cable Side
+		Code Key
-	Code Key	
⊕ (PE)		Code Key





- Installation**
1. Take the 88-300 VDC PSU out of the antistatic bag.
  2. Slide the PSU in the allocated slot of the node (see corresponding Node form).
  3. VERY IMPORTANT: Tighten the PSU with the two fastening screws for optimal contact.



The DC power supplies/cables have a coding profile or code keys to prevent that a wrong cable and voltage is plugged into the PSU.

- 
4. Connect the power distribution via the power cord to the PSU and tighten the 2 screws for locking the power cord.
  5. Label the power cord(s).
  6. If necessary, the node can be powered on as described in §3.2.
-

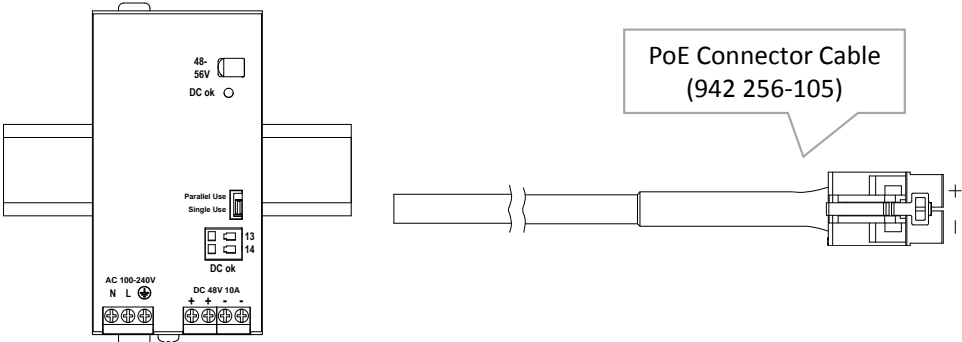
## 4.8 ACPoE-A DIN Rail PSU/100-240 VAC ± 10 % - 48 VDC DIN RAIL PSU (942 235-001)

Engineer type	Section	Form: Installation of an ACPoE-A DIN Rail PSU
 <p>Duration: 30 min.</p>	<p><b>ESD</b></p>	<p>With all installation activities, the ESD recommendations regarding the handling, transportation and storage of cards must be adopted. A full ESD description can be found in chapter 18.</p> <div style="display: flex; align-items: center; margin-top: 10px;">  <p><i>Always wear an antistatic wristband in direct contact with your skin. Connect the alligator clip to the blank metal of the rack or plug the antistatic wristband into the ESD bonding point.</i></p> </div>
	<p><b>Installation Equipment</b></p>	<ul style="list-style-type: none"> <li>• Key of the rack (if necessary)</li> <li>• Screwdriver set, cable ties and cable tool set</li> <li>• Antistatic wristband</li> <li>• NSM-A Module in a Dragon PTN node / DCPoE-A DIN Rail PSU + Power cord (if not pre-installed)</li> <li>• PoE Connector Cable: 942 256-105</li> <li>• Extra documentation can be found in chapter 15</li> </ul>
	<p><b>Front Panel</b></p>	
	<p><b>Installation of PoE PSU on the NSM-A module</b></p>	<ol style="list-style-type: none"> <li>1. Take the ACPoE-A DIN Rail PSU out of the antistatic bag.</li> <li>2. Mount the DIN RAIL inside the rack (if not already done).</li> <li>3. Clip the PSU onto the DIN RAIL.</li> <li>4. Label the PSU to identify to which switch it is connected.</li> <li>5. Limit power cable (2 x 2.5 mm<sup>2</sup>) length to 3 m for EMC compliancy.</li> <li>6. Connect the PoE connector cable to the PSU via connecting the open ends of the cable to the PSU outputs '++--': respect the polarity.</li> <li>7. Connect the main power (220 VAC) to the PSU via connecting the open ends of the standard power cable to the "L", "N" and GND on the PSU.</li> </ol> <div style="text-align: center; margin: 10px 0;">  </div> <ol style="list-style-type: none"> <li>8. Plug in the PoE connector cable in the POE1 or POE2 connector on the NSM-A in the node.</li> </ol>

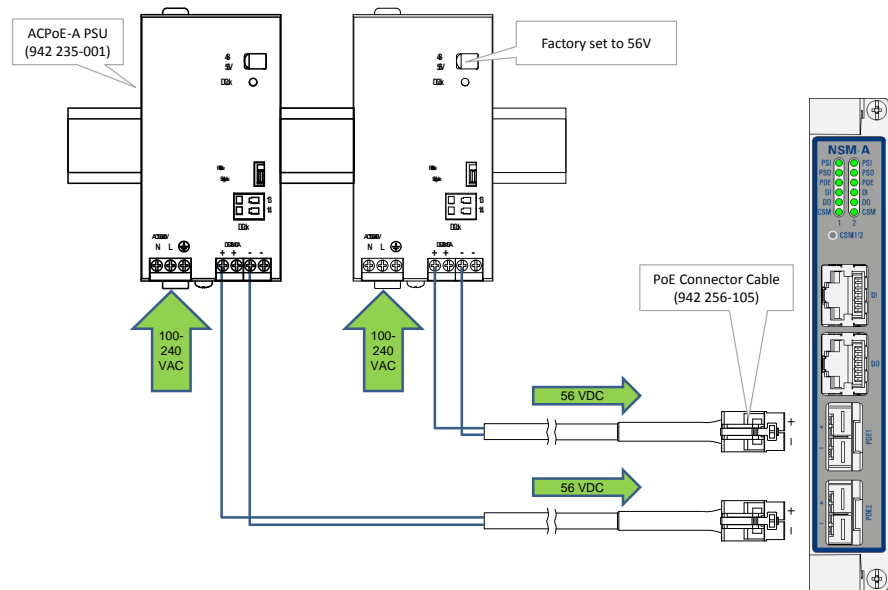

9. If a second PSU is required, repeat steps 1 to 8. DC1 and DC2 support reverse polarity protection.
10. Label the power cord(s).

## 4.9 DCPoE-A DIN Rail PSU/ 33-62 VDC(in) - 56 VDC(out) DIN RAIL PSU (942 235-002)

Engineer type	Section	Form: Installation of an DCPoE-A DIN Rail PSU
---------------	---------	---



### ESD

With all installation activities, the ESD recommendations regarding the handling, transportation and storage of cards must be adopted. A full ESD description can be found in chapter 18.



*Always wear an antistatic wristband in direct contact with your skin. Connect the alligator clip to the blank metal of the rack or plug the antistatic wristband into the ESD bonding point.*

Duration:  
30 min.

### Installation Equipment

- Key of the rack (if necessary)
- Screwdriver set, cable ties and cable tool set
- Antistatic wristband
- NSM-A Module in a Dragon PTN node / DCPoE-A DIN Rail PSU + Power cord (if not pre-installed)
- PoE Connector Cable: 942 256-105
- Extra documentation can be found in chapter 15

### PSU Front Panel

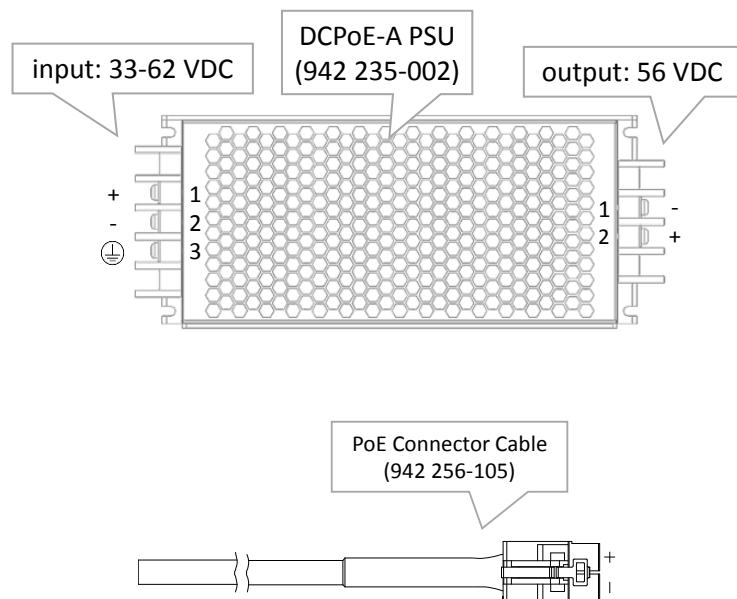

### Installation for NSM-A



**Always use a grounded appliance outlet to connect the power supply. Never apply an excess input voltage to the DC input power ports, and do respect the polarity.**

1. Take the DCPoE-A DIN Rail PSU and DIN Rail accessories out of the antistatic bag.
2. Mount the DIN Rail inside the rack (if not already done).
3. Mount the DIN Rail clip on the back of the standard mounting plate (222x96x2.5mm) (for high temperature operation, see further).
4. Mount the PSU on the front of the standard mounting plate.

5. Clip the PSU onto the DIN Rail.
6. Label the PSU to identify to which Node or NSM-A it is connected.
7. Limit power cable (2 x 2.5 mm<sup>2</sup>) length to 3 m for EMC compliancy.
8. Connect the PoE connector cable to the PSU via connecting the open ends of the PSU cable to the PSU outputs: **respect the polarity**.
9. Connect the DC input power (33-62 VDC) to the PSU inputs via connecting the open ends of the standard power cable (3 x 2.5 mm<sup>2</sup>) to the "+", "-" and GND on the PSU.
10. Plug in the PoE connector cable in the POE1 or POE2 connector on the NSM-A in the node.

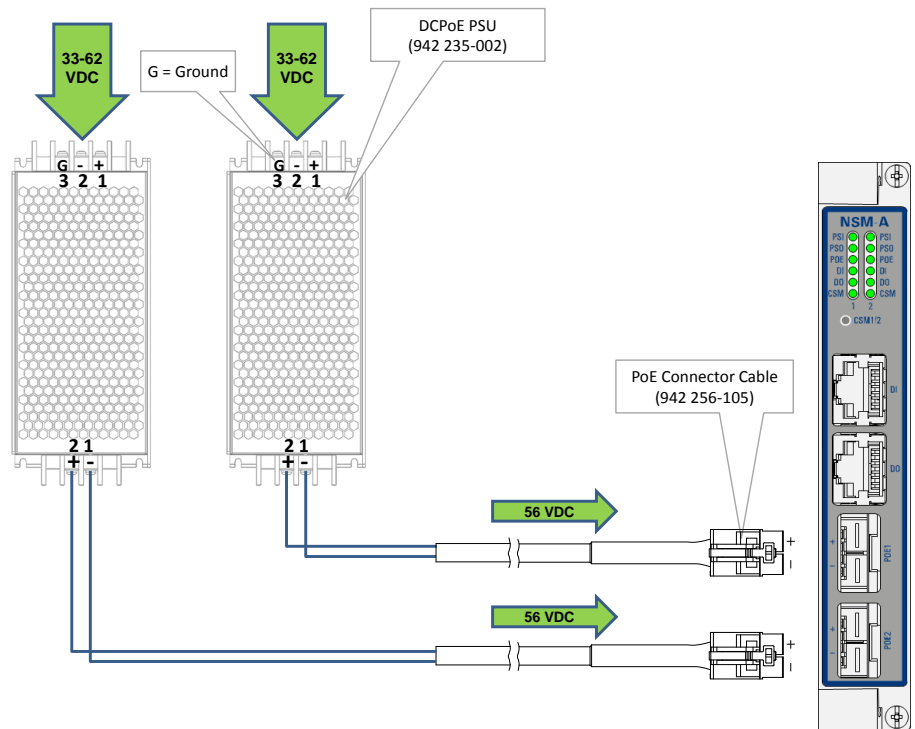

11. If a second PSU is required, repeat steps 1 to 8.
12. Label the power cord(s).

### Standard Mounting Plate

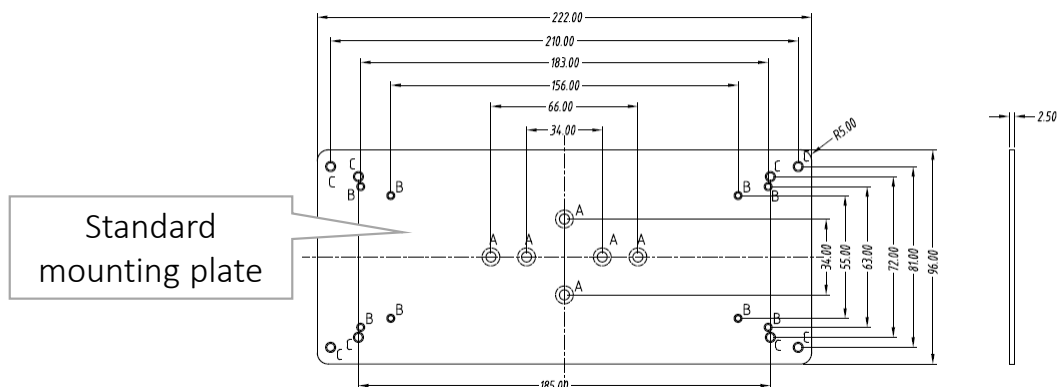

### Cooling Wall Plate

- If it is necessary that the DCPoE-A PSU 942 235-002 must operate fully-loaded at 70°C, the PSU must be directly mounted, without DIN Rail, on an aluminum/metal wall plate for cooling reasons. The cooling area on the plate must be at least 360x360x2mm. See below.



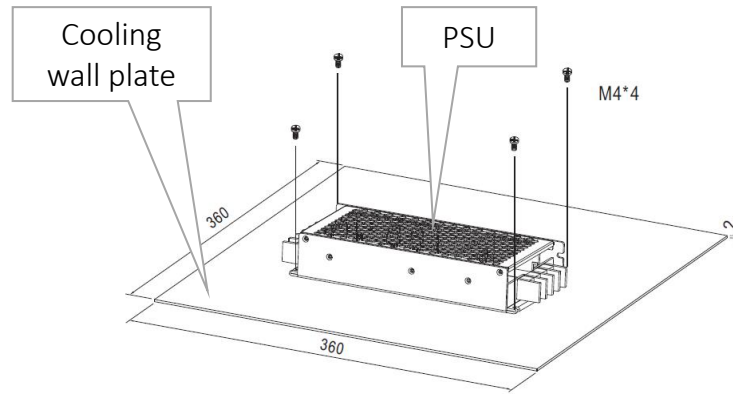

## **Node Support Modules - Installation Forms**

## 5. NODE SUPPORT MODULES – INSTALLATION FORMS

The NSM is required in every Dragon PTN node and performs following functions via its front panel:

- ▶ Status indication of PSU(s) and CSM(s);
- ▶ Status and connection of Digital I/O (I= Input; O=output);
- ▶ Status and connection of PoE Power inputs (redundant), only on NSM-A;
- ▶ Manual switch over from the active to the redundant standby CSM via hidden push button;



**CAUTION:** Some parts of the node can be extremely hot. Therefore, it is strongly advised to use only the front panel handles of the module (NSM, CSM, IFM & PSU), and not touching the PCB or any other parts, when removing it from the node.

---



**Always use the front panel handles to plug in/remove an NSM into/from a node. Do not touch or bend the EMC spring on the side of the front panel.**

---

The NSM-A has 2 PoE connectors on the front panel to connect 2 external PoE sources or PSUs. One or two AC/DC (=ACPoE-A) or DC/DC (=DCPoE-A) PSUs, or a mix can be connected to the NSM.

Two connected PSUs will operate redundantly. Power aggregation is not supported. When two PSUs are connected, always the lowest power of both PSUs will be taken by HiProvision to calculate the PoE power.

For the configuration in HiProvision, see 'Power over Ethernet (PoE)' in the 'Dragon PTN and HiProvision operation manual', see chapter 15.

Following PSUs can be ordered:

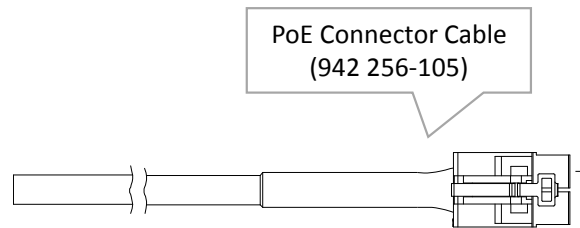

- ▶ ACPoE-A DIN Rail PSU (942 235-001), see §4.8 for installation form;
- ▶ DCPoE-A DIN Rail PSU (942 235-002), see §4.9 for installation form;

For connecting an external power supply for providing PoE, following cable (942 256-105) is required:



PSU for PoE	Order numbers
<b>ACPoE-A: External DIN Rail PSU</b> <b>Input: AC 100-240V (=wide range)</b> <b>Output: DC 48-54V (factory set 48 V)</b>	942 235-001
<b>DCPoE-A: External DIN Rail PSU (DIN Rail accessories included)</b> <b>Input: DC 33 - 62V (=wide range)</b> <b>Output: DC 56V (factory set)</b>	942 235-002
<b>PoE Cable</b>	942 256-105

## 5.1 NSM-A (942 229-001), NSM-B (942 229-002)

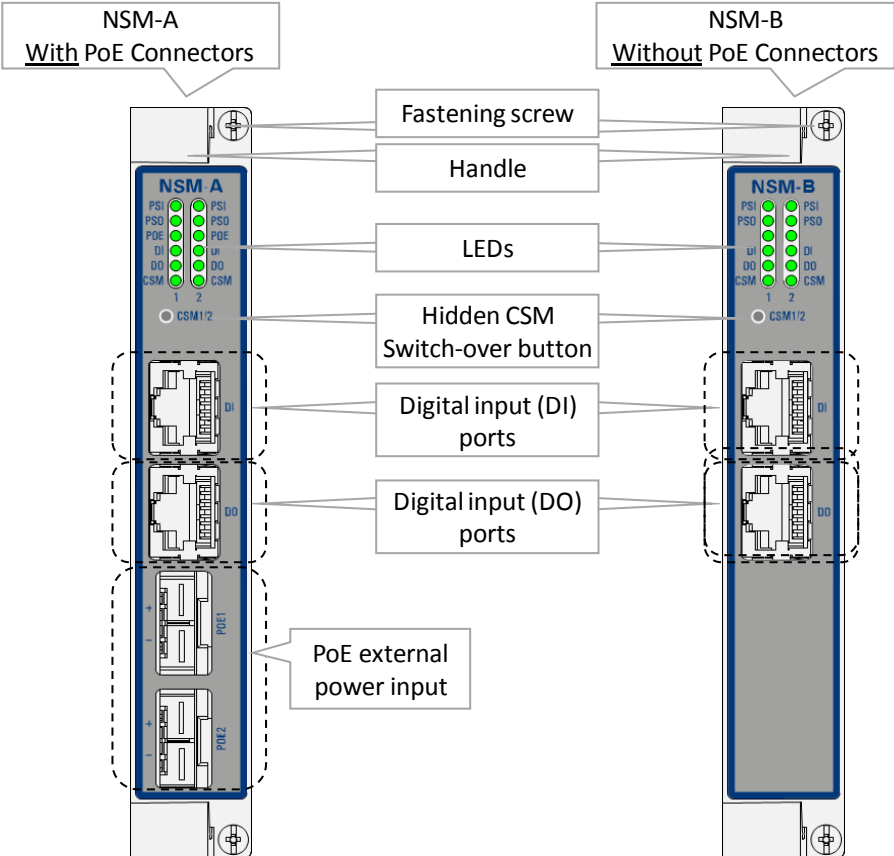
Engineer type	Section	Form: Installation of an NSM-A/NSM-B
	<p><b>ESD</b></p>	<p>With all installation activities, adopt the ESD recommendations regarding the handling, transportation and storage of modules. Find a full ESD description in chapter 18.</p>
<p>Duration: 15 min.</p>		<p><i>Always wear an antistatic wristband in direct contact with your skin. Connect the alligator clip to the blank metal of the rack or plug the antistatic wristband into the ESD bonding point.</i></p>
<p><b>Installation Equipment</b></p>	<ul style="list-style-type: none"> <li>▶ Key of the rack (if necessary)</li> <li>▶ Screwdriver set</li> <li>▶ Antistatic wristband</li> <li>▶ NSM-A/NSM-B and Ethernet and PoE cable(s) if required. (PoE only on NSM-A)</li> <li>▶ Extra documentation can be found in chapter 15</li> </ul>	
<p><b>Compatibility</b></p>	<p>✔</p>	<p><b>XT-1104-A/XT-2206-A/ XT-2209-A/XT-2210-A Node</b>      Weight: approx. 0.17 kg / 0.4 lb</p>
<p><b>Front Panel</b></p>		

## Installation

1. Remove the ESD packaging from the NSM, do not touch or bend the EMC spring on the side of the front panel.
2. Identify the node where the NSM has to be installed. The NSM must always be installed in the most left position. (see corresponding node form).
3. Take the NSM with the front panel handles, aim correctly and slide it through the correct card guides (see chapter §3.2) into the NSM slot.
4. Push the module as far as possible into the node.



### Choosing another slot can damage the NSM

5. Push firmly with your thumbs on the front panel for optimal backplane contact.
6. Tighten the two fastening screws.
7. If digital input is required, connect Ethernet cables to the DI connector.
8. If digital output is required, connect Ethernet cables to the DO connector.
9. (on NSM-A) If PoE is required, connect the PoE external PSU(s) via 942 256-105 cable(s) to PoE1 and/or PoE2 connector, see figure below.

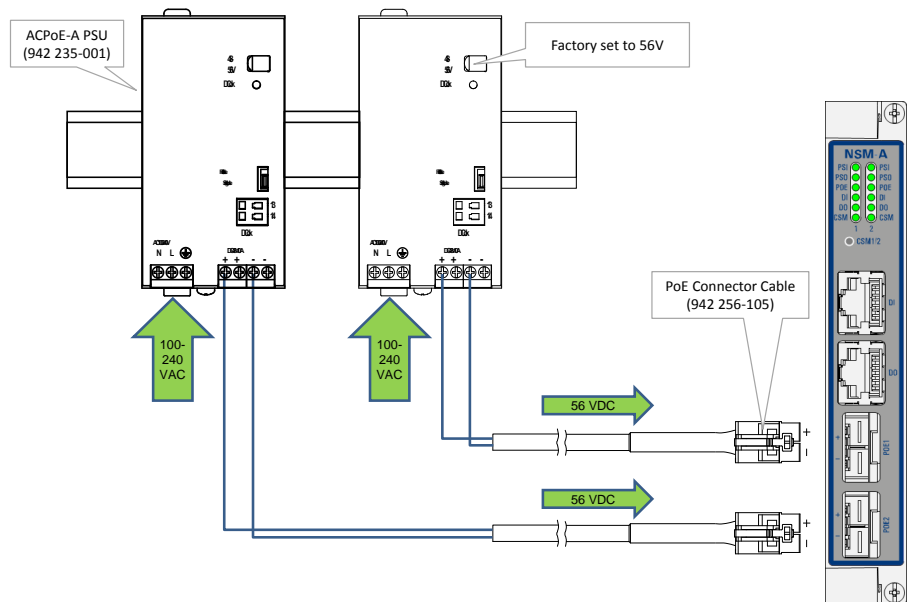

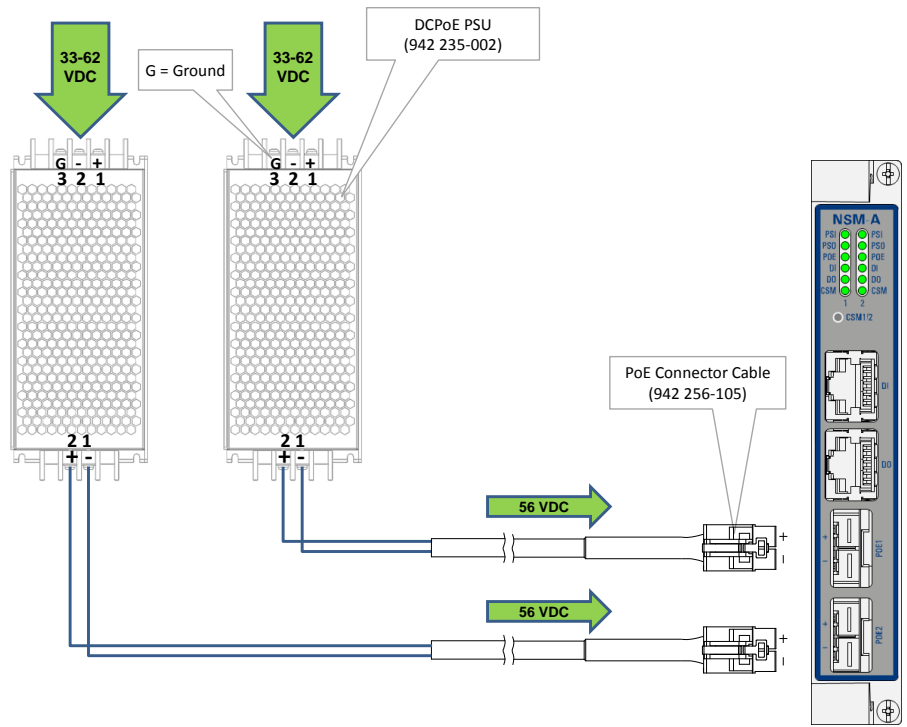

Engineer type	Section	Form: Operation of an NSM-A/NSM-B
---------------	---------	-----------------------------------



**ESD**

With all installation activities, adopt the ESD recommendations regarding the handling, transportation and storage of modules. Find a full ESD description in chapter 18.

Duration:  
1 hour



*Always wear an antistatic wristband in direct contact with your skin. Connect the alligator clip to the blank metal of the rack or plug the antistatic wristband into the ESD bonding point.*

**Installation Equipment**

- ▶ Key of the rack (if necessary)
- ▶ Screwdriver set
- ▶ Antistatic wristband
- ▶ Extra documentation can be found in chapter 15

**Operation**

1. Un-tighten the screws on the NSM and remove the module from the node (module = hot-swappable), do not touch or bend the EMC spring on the side of the front panel.
2. Configure all rotary switches (see section below);
3. Take the NSM with the front panel handles, aim correctly and slide it through the correct card guides (see chapter §3.2) into the NSM slot.
4. Push the module as far as possible into the node.
5. Push firmly with your thumbs on the front panel for optimal backplane contact;
6. Tighten the two fastening screws.
7. Continue installing and configuring the CSM (see CSM form). After CSM installation, the node number configured on the NSM can be verified on the CSM display.

**Rotary Switches**

1. Take the NSM and set the correct node number on the module with the rotary switches S3 to S6 (S6 = most significant, see next page). Valid decimal node numbers range from 0001 to 8999. The configured node number can be verified on the CSM display. Node number 9001 on the CSM display means that the configured node number on the NSM is invalid.



- ▶ The hardware edition (labeled as CARD\_ID) of the NSM has been factory set with rotary switch S1 and S2 (=most significant) and **MUST NOT BE CHANGED!**
- ▶ A hidden CSM switch-over button (SW1) is available on the NSM to make a switch-over from the active to the redundant standby CSM (not applicable on the XT-1104-A node).



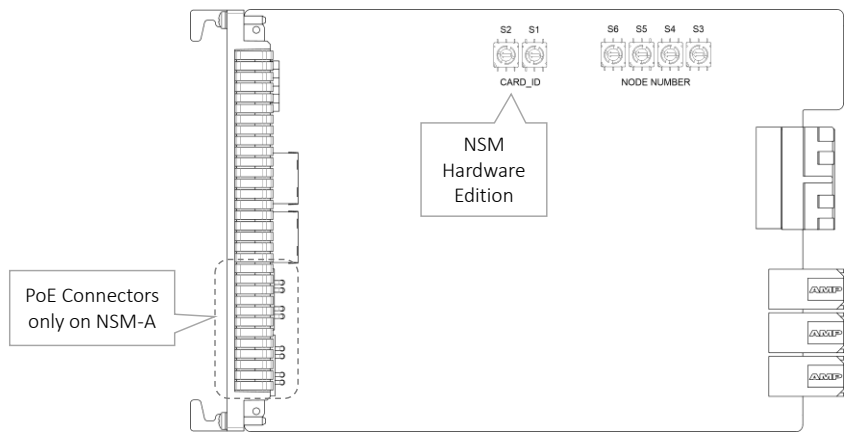

NSM-A Side view

Example: Node N° = 219

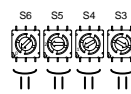

Dec → 0 2 1 9

**Node Number Example**

2. **Status info via NSM-A LEDs:** See node manual listed in §15 for more information on the NSM LEDs.

## **Central Switching Module – Installation Forms**

## 6. CENTRAL SWITCHING MODULE – INSTALLATION FORMS

### 6.1 General

The CSM310-A Central Switching Module (=CSM) is the heart of the Dragon PTN nodes. This module provides the main processing within the Dragon PTN nodes via an Integrated Ethernet Multilayer Switch and Traffic Manager on board. **All CSMs in the same Dragon PTN network must have the same firmware installed compatible with the installed HiProvision version.**



**CAUTION:** Some parts of the node can be extremely hot. Therefore, it is strongly advised to use only the front panel handles of the module (NSM, CSM, IFM & PSU), and not touching the PCB or any other parts, when removing it from the node.

---



Always use the front panel handles to plug in/remove a CSM into/from a node. Do not touch or bend the EMC spring on the side of the front panel.

---

The XT-2210-A/XT-2209-A/XT-2206-A nodes can be equipped with one or 2 CSMs in any of the CSM positions. If no redundant CSM is provided, **the empty CSM position must be covered with a cover plate: 942 237-003.**

Each CSM is equipped with a Micro SD Memory card (see further on). This memory card has one purpose: allow the easy replacement of an erroneous CSM in the live network. This memory card always holds the latest node configuration downloaded via HiProvision.



**CAUTION:**

- ▶ The SD card from a broken CSM can be reused in the new replacing CSM provided that both CSMs have the same firmware version and are used in the same node!
  - ▶ A used Micro SD Memory card must always be used in the same node! Always use the front panel handles to plug in/remove a CSM into/from a node.
  - ▶ When installing a redundant CSM, both CSMs must have the same firmware version.
- 

Follow the steps below to replace an erroneous CSM with a new CSM:

- ▶ Remove the SD card from the new CSM by pushing down and releasing the SD card;
- ▶ Remove the erroneous CSM (=hot-swappable) from the powered node;
- ▶ Remove the SD card from the erroneous CSM and insert it into the new CSM;
- ▶ Plug in the new CSM into the node. The node will reboot with the new CSM, which already has the correct node configuration from the SD card. A new load of the node via HiProvision will not be necessary.

## 6.2 CSM310-A (942 230-001)

Engineer type	Section	Form: Installation of a CSM310-A
---------------	---------	----------------------------------



### ESD

With all installation activities, adopt the ESD recommendations regarding the handling, transportation and storage of modules. Find a full ESD description in chapter 18.

Duration:  
30 min.



*Always wear an antistatic wristband in direct contact with your skin. Connect the alligator clip to the blank metal of the rack or plug the antistatic wristband into the ESD bonding point.*

### Installation Equipment

- ▶ Key of the rack (if necessary)
- ▶ Screwdriver set
- ▶ Antistatic wristband
- ▶ CSM310-A (includes pre-installed Micro SD memory card)
- ▶ Extra documentation can be found in chapter 15

### Compatibility



**XT-1104-A/XT-2206-A/  
XT-2209-A/XT-2210-A**

Weight: approx. 1 kg / 2.2 lb

### Front Panel

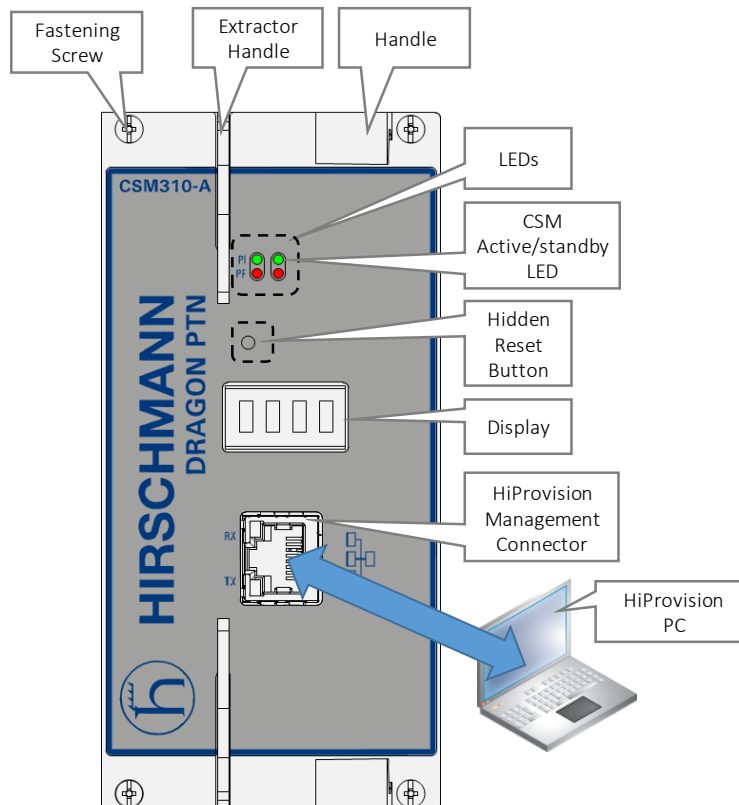

### Installation

1. Remove the ESD packaging from the CSM, do not touch or bend the EMC spring on the side of the front panel.
2. Identify the Dragon PTN node where the CSM has to be installed (see allocated slot below):

### XT-1104-A

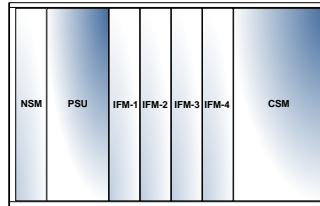

### XT-2206-A

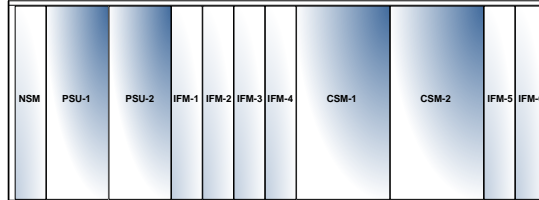

### XT-2209-A

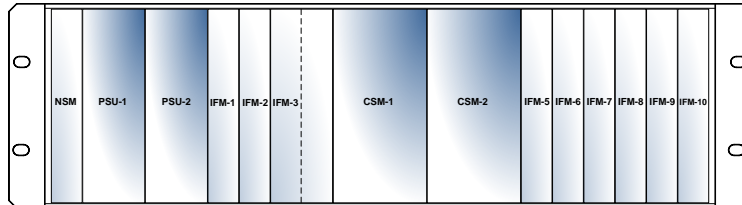

### XT-2210-A

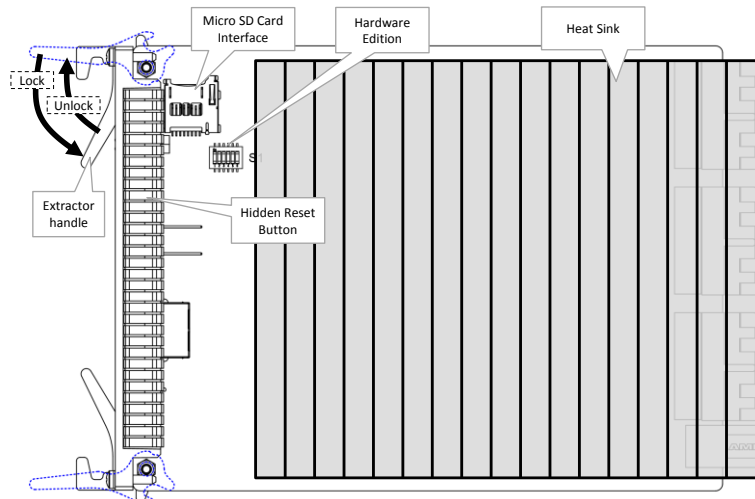
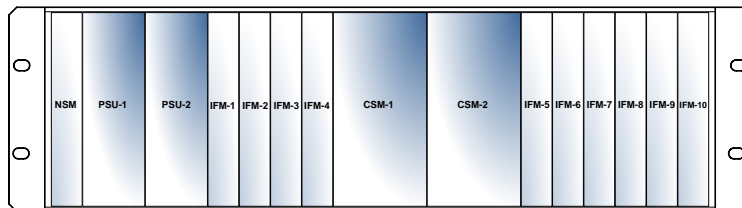

3. Set/hold the extractor handles unlocked or horizontal, in line with the top of the module.
4. Take the CSM with the front panel handles, aim correctly and slide the module through the two bottom/top card guides (see

chapter §3.2) into the CSM slot. When inserting one CSM into an XT-2210-A/XT-2209-A/XT-2206-A node, use the 'CSM-1' or 'CSM-2' slot. When using redundant CSMs, CSMs must be inserted in both 'CSM-1/CSM-2' slots.

5. Push the module as far as possible into the node. Make sure that the extractor handles can grab into the foreseen top/bottom holes of the node.
6. Inward push or lock the extractor handles.
7. Push firmly with your thumbs on the front panel for optimal backplane contact.
8. Tighten the four fastening screws.

Engineer type	Section	Form: Operation of a non-redundant CSM310-A
---------------	---------	---



**ESD**

With all installation activities, adopt the ESD recommendations regarding the handling, transportation and storage of modules. Find a full ESD description in chapter 18.

Duration:  
30 min.



*Always wear an antistatic wristband in direct contact with your skin. Connect the alligator clip to the blank metal of the rack or plug the antistatic wristband into the ESD bonding point.*

**Installation Equipment**

- ▶ Key of the rack (if necessary)
- ▶ Screwdriver set
- ▶ Antistatic wristband
- ▶ Extra documentation can be found in chapter 15

**Operation**

1. **PREREQUISITE:** node number is configured on the NSM and SD Memory card is plugged into its interface, see below.
2. CSM is hot-swappable, remove the CSM from the node (see the section below).
3. **DO NOT** change the hardware edition DIP switch (S1).
4. Make sure that a Micro SD card is plugged in.

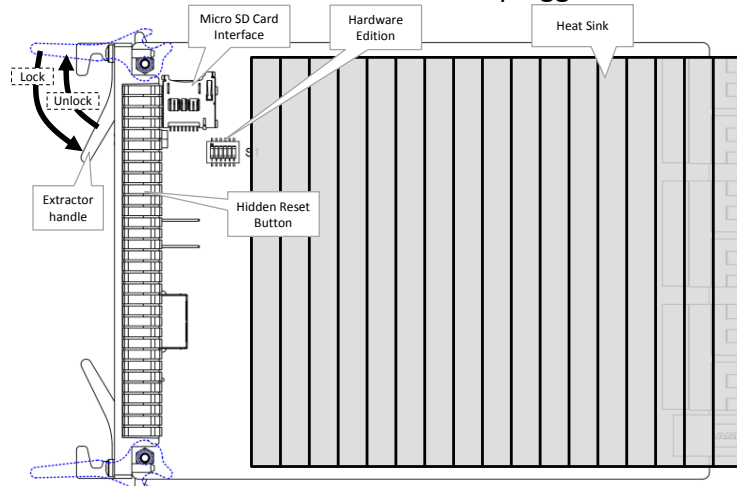

5. Insert the CSM into the node (see the section below).

- 
6. Check if the LED(s) 'PSI' and 'PSO' on the NSM are lit. If they are both green the node will start up.
  7. The CSM turns into a boot cycle which lasts approximately 5 minutes.
  8. After this boot cycle, check if the PI LED is green, the PF and the FLT LED must not lit. The CSM active LED (or spare LED) must be green.
  9. Write down the node number (for later use) from the CSM display. This is the node number configured on the NSM.
  10. Program the CSM (see section below).
- 

#### **Insert CSM**

1. Set the extractor handles unlocked or horizontal, in line with the top of the module.
  2. Take the CSM with the front panel handles, aim correctly and slide the module through the two bottom/top card guides (see chapter §3.2) into the CSM slot.
  3. Push the module as far as possible into the node. Make sure that the extractor handles can grab into the foreseen top/bottom holes of the node.
  4. Inward push or lock the extractor handles.
  5. Push firmly with your thumbs on the front panel for optimal backplane contact.
  6. Tighten the four fastening screws.
- 

#### **Remove CSM**



**CAUTION:** if powered on, the CSM can be extremely hot. Therefore, it is strongly advised to use only the front panel handles and not touching the PCB or any other parts, when removing it from the node. The CSM can be rather heavy as well due to the weight of the heat sink.

1. **ATTENTION:** if powered on and programmed, the node goes out of service after performing the steps below.
  2. Un-tighten the four fastening screws.
  3. Outward push or unlock the extractor handles as far as possible to unlock the CSM from the node backplane.
  4. Take the front panel handles to pull out the CSM, CSM is hot-swappable, do not touch or bend the EMC spring on the side of the front panel.
  5. Remove the CSM from the node.
- 

#### **Program CSM**



A trained HiProvision administrator must perform the HiProvision steps below in the control center. A full description of the steps below can be found in 'Dragon PTN and HiProvision Operation' manual, see chapter 15.

1. Use your cell phone to communicate with the control center and ask them to program the CSM in HiProvision.
  2. In HiProvision, discover the network elements and links in the Dragon PTN Network.
  3. In HiProvision, approve the Dragon PTN Network.
  4. In HiProvision, configure all the network elements and links in the
-

database. This could be done automatically via the discover and approve steps, or it can be done manually.

5. In HiProvision, program tunnels;
6. In HiProvision, program services;
7. Contact the control center to check if the CSM is functioning properly after having it discovered and programmed in HiProvision.

Engineer type	Section	Form: Operation of a redundant CSM310-A (XT-2210-A/XT-2209-A/XT2206-A)
---------------	---------	--



**ESD**

With all installation activities, adopt the ESD recommendations regarding the handling, transportation and storage of modules. Find a full ESD description in chapter 18.

Duration:  
30 min.



*Always wear an antistatic wristband in direct contact with your skin. Connect the alligator clip to the blank metal of the rack or plug the antistatic wristband into the ESD bonding point.*

**Installation Equipment**

- ▶ Key of the rack (if necessary)
- ▶ Screwdriver set
- ▶ Antistatic wristband
- ▶ Extra documentation can be found in chapter 15

**Operation**

1. **PREREQUISITES:** Node number has been configured on the NSM and SD Memory card is plugged into its interface, see below. Both CSMs must have the same firmware version to allow CSM redundancy.
2. The CSM is hot-swappable, remove the redundant (standby) CSM from the node (see the section below). (CAUTION: Never pull out the active CSM).
3. DO NOT change the hardware edition DIP switch (S1).
4. Make sure that a Micro SD card is plugged in.



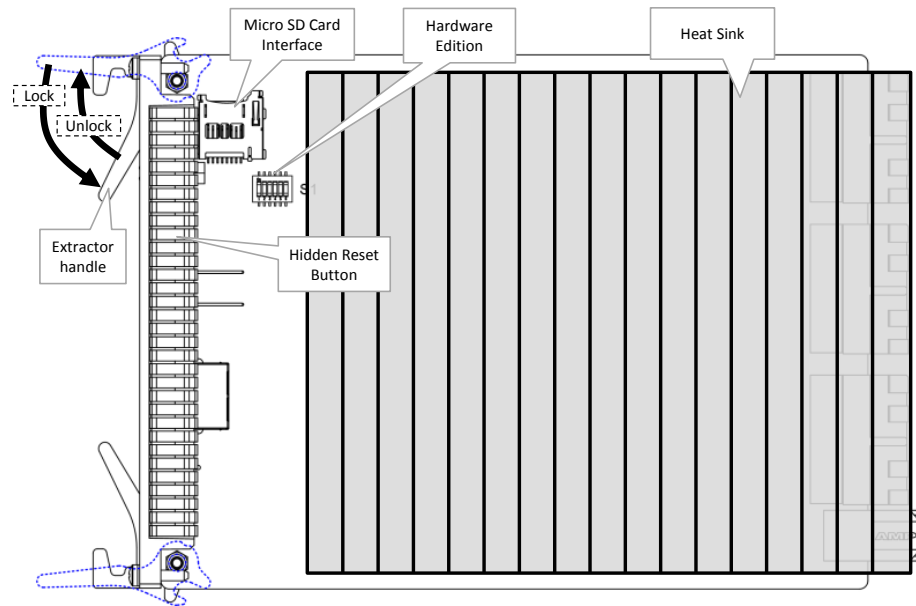

5. Insert the redundant CSM in the node (see the section below).
6. Check if the LED(s) 'PSI' and 'PSO' on the NSM are lit. If they are both green the node will start up.
7. The CSM turns into a boot cycle which lasts approximately 5 minutes.
8. After this boot cycle, check if the PI LED is green, the PF and the FLT LED must not lit. The CSM active LED (or spare LED) must be **dark**.

**CAUTION: If the spare LED on both redundant CSMs are lit together, it means that both CSMs are active at the same time. This is not allowed! Make sure that both CSMs are plugged in properly.**

9. Write down the node number (for later use) from the CSM display. This is the node number configured on the NSM.
10. Program the CSM (see section below).

### **Insert CSM**

1. Set/hold the extractor handles unlocked or horizontal, in line with the top of the module.
2. Take the CSM with the front panel handles, aim correctly and slide the module through the two bottom/top card guides (see chapter §3.2) into the CSM slot.
3. Push the module as far as possible into the node. Make sure that the extractor handles can grab into the foreseen top/bottom holes of the node.
4. Inward push or lock the extractor handles.
5. Push firmly with your thumbs on the front panel for optimal backplane contact;
6. Tighten the four fastening screws.

---

## Remove CSM



**CAUTION:** if powered on, the CSM can be extremely hot. Therefore, it is strongly advised to use only the front panel handles and not touching the PCB or any other parts, when removing it from the node. The CSM can be rather heavy as well due to the weight of the heat sink.

1. **ATTENTION:** if powered on and programmed, the node goes out of service after performing the steps below.
2. Un-tighten the four fastening screws.
3. Outward push or unlock the extractor handles as far as possible to unlock the CSM from the node backplane.
4. Take the front panel handles to pull out the CSM, CSM is hot-swappable, do not touch or bend the EMC spring on the side of the front panel.
5. Remove the CSM from the node.

---

## Program CSM



A trained HiProvision administrator must perform the HiProvision steps below in the control center. A full description of the steps below can be found in 'Dragon PTN and HiProvision Operation' manual, see chapter 15.

1. Use your cell phone to communicate with the control center and ask them to program the CSM in HiProvision.
  2. In HiProvision, discover the nodes and links in the Dragon PTN Network.
  3. In HiProvision, approve the Dragon PTN Network.
  4. In HiProvision, configure all the network elements and links in the database. This could be done automatically via the discover and approve steps, or it can be done manually.
  5. In HiProvision, program tunnels;
  6. In HiProvision, program services;
  7. Contact the control center to check if the CSM is functioning properly after having it discovered and programmed in HiProvision.
-

## **Interface Modules – Installation Forms**

## 7. INTERFACE MODULES – INSTALLATION FORMS

Dragon PTN provides a range of interface modules for diverse applications:

- ▶ Local Area Networks (LAN), Wide Area Networks (WAN), IP applications (e.g. Gigabit Ethernet, Fast Ethernet)
- ▶ Telephony purposes (e.g. SHDSL, E1, T1, C37.94....)

Each Interface Module (=IFM) has its own manual, which can be found on the Portal <https://hiprovision.hirschmann.com> via Shortcuts → Manuals. See chapter 15 for details.

Dragon PTN nodes provide universal mounting positions for up to ten IFMs. Both low speed (1G) and high speed (10G) IFMs can be used together in the same node. In which slot the node can be plugged depends on the speed type (1G or 10G) of the IFM and the node type. See figures below:

XT-2210-A: Node Slot Speeds

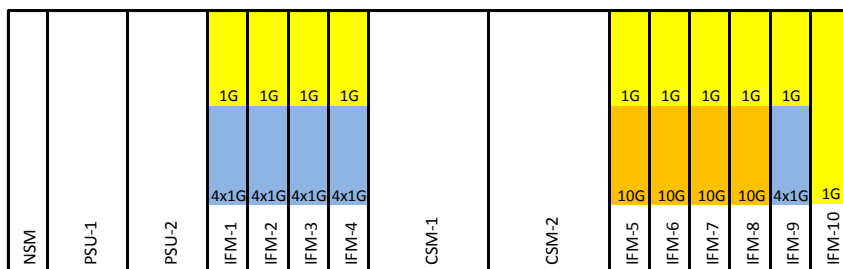

XT-2209-A: Node Slot Speeds

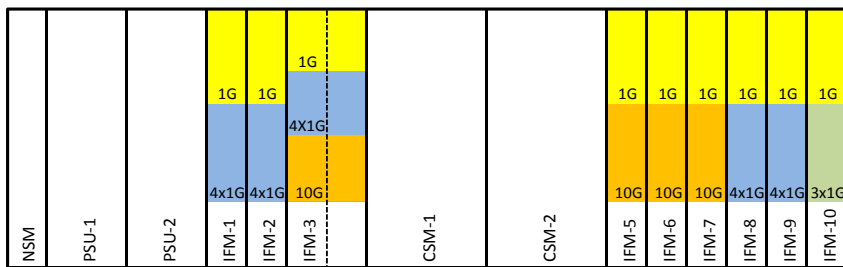

XT-2206-A: Node Slot Speeds

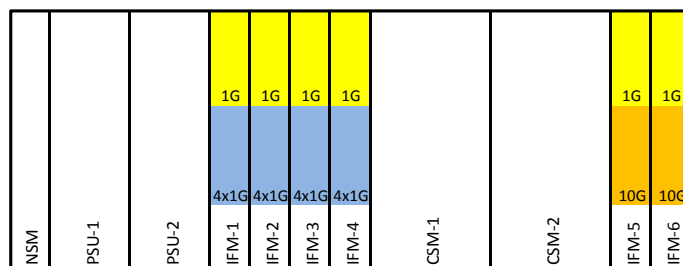

XT-1104-A: Node Slot Speeds

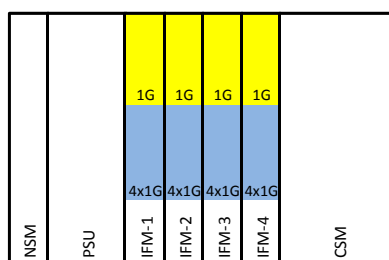

For the correct programming of the interface modules, see the module documentation and the 'Dragon PTN and HiProvision Operation' manual, see chapter 15.

Interface modules can be removed from and inserted into the node while the power is on (hot swappable). Detailed installation forms with cable information of all common Dragon PTN interface modules are listed in this chapter.



- ▶ Identify all interface cables with labels after installing the Dragon PTN equipment.
  - ▶ All cables coming from the front of the node must be guided to the side of the node and not to top or bottom side, this way the natural airflow through the node is not blocked or disturbed.
  - ▶ Cover all empty interface slots with the corresponding cover plate. (Dummy panel: 942 237-001)
  - ▶ Always use the front panel handles to plug in/remove an NSM into/from a node. Do not touch or bend the EMC spring on the side of the front panel.
- 



- ▶ All interface modules with RJ45 connectors must be connected with CAT5E Shielded cables except the E1 and T1 cables.
- 



**CAUTION:** Some parts of the node can be extremely hot. Therefore, it is strongly advised to use only the front panel handles of the module (NSM, CSM, IFM & PSU), and not touching the PCB or any other parts, when removing it from the node.

---

## 7.1 General Recommendations: Optical Connectors, Laser Diodes and Fibers

Applicable for the 1G and 10G interface modules.



- ▶ Avoid fiber optical connector contamination!
  - ▶ Always shield the disconnected optical connectors (either on the module or fiber) by means of a plastic cap. This prevents the optical signal from being disturbed by possible dust and dirt.
  - ▶ Save these dust caps carefully, so they can be put on the transmitter and/or receiver again on both the module and fiber connector during another power measurement, node removal, etc.
  - ▶ Always clean the front face and the ferrule of the fiber connector before plugging it in into the interface module - exclusively use a fiber cleaning tool.
  - ▶ Not adopting these rules causes the connector concerned and other optical elements to get dirty and/or be damaged. It is practically impossible to remove the dirt once it is inside the connector, which may also cause a loss of several dB.
  - ▶ Avoid contact with Laser Diode Pins! Laser diodes are extremely sensitive to electrostatic discharges. The slightest over voltage may cause component degradation, or even component destruction. Therefore, avoid any contact with the laser diode pins and with the switch near this component.
  - ▶ The fastening screws on the modules need to be tightened prior to connecting the installation wiring. Vice versa, the installation wiring needs to be removed prior to un-tightening the modules.
  - ▶ Do not damage the fibers during installation! Keep the tensile force on the fiber down and respect sufficient bend radius. Use soft (e.g. Velcro) instead of hard plastic cable binders. Pay attention when tightening them, not to tight!
-

7.2 2-C37.94 (With E1: 942 236-009 / With T1: 942 236-010)

Engineer type	Section	Form: Installation of a 2-C37.94 module
---------------	---------	---



ESD

With all installation activities, adopt the ESD recommendations regarding the handling, transportation and storage of modules. Find a full ESD description in chapter 18.

Duration:  
1 hour



*Always wear an antistatic wristband in direct contact with your skin. Connect the alligator clip to the blank metal of the rack or plug the antistatic wristband into the ESD bonding point.*

**Installation Equipment**

- ▶ Key of the rack (if necessary)
- ▶ Screwdriver set, cable ties and cable tool set
- ▶ Antistatic wristband
- ▶ 2-C37.94 module + SFP modules
- ▶ Interface cable(s)
- ▶ Extra documentation can be found in chapter 15

**Compatibility**





**XT-1104-A/XT-2206-A/  
XT-2209-A/XT-2210-A**

Weight: approx. 0.22 kg / 0.5 lb

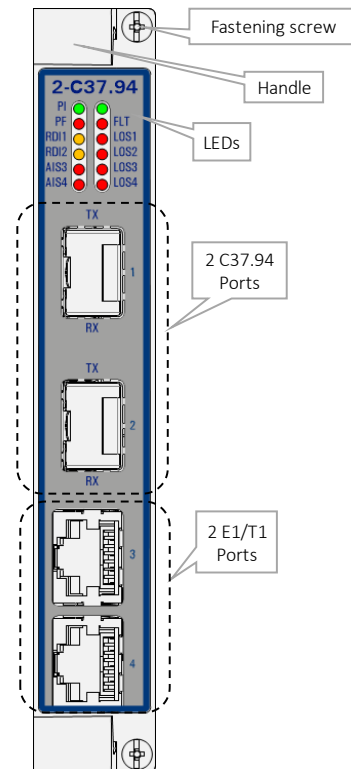
**Front Panel**



- Installation**
1. Remove the ESD packaging from the interface module, do not touch or bend the EMC spring on the side of the front panel.
  2. Take the 2-C37.94 module with the front panel handles, aim correctly and slide it through the correct card guides (see chapter §3.4) into the allocated slot.
  3. Push the module as far as possible into the node.
  4. Push firmly with your thumbs on the front panel for optimal backplane contact.
  5. Tighten the two fastening screws.
  6. Plug the SFP module in the corresponding position (see §7.15).
  7. Plug the interface cable(s) into the corresponding connector(s) (see next page(s) for pin numbers, signal names and color codes).

Engineer type	Section	Form: Operation of a 2-C37.94 module
 <p>Duration: 10 min.</p>	<p><b>ESD</b></p>	<p>With all installation activities, adopt the ESD recommendations regarding the handling, transportation and storage of modules. Find a full ESD description in chapter 18.</p> <div style="display: flex; align-items: center; justify-content: center;">  <p><i>Always wear an antistatic wristband in direct contact with your skin. Connect the alligator clip to the blank metal of the rack or plug the antistatic wristband into the ESD bonding point.</i></p> </div>
<p><b>Installation Equipment</b></p>		<ul style="list-style-type: none"> <li>▶ Key of the rack (if necessary)</li> <li>▶ Screwdriver set, cable ties and cable tool set</li> <li>▶ Antistatic wristband</li> <li>▶ Extra documentation can be found in chapter 15</li> </ul>
	<p><b>Operation</b></p>	<ol style="list-style-type: none"> <li>1. Un-tighten the screws on the 2-C37.94 module and remove the module from the node (module = hot-swappable), do not touch or bend the EMC spring on the side of the front panel.</li> <li>2. The E1/T1 configuration of the 2-C37.94 module is factory set by the S1 DIP switch and must not be changed. The configuration can be read out via HiProvision.</li> </ol>

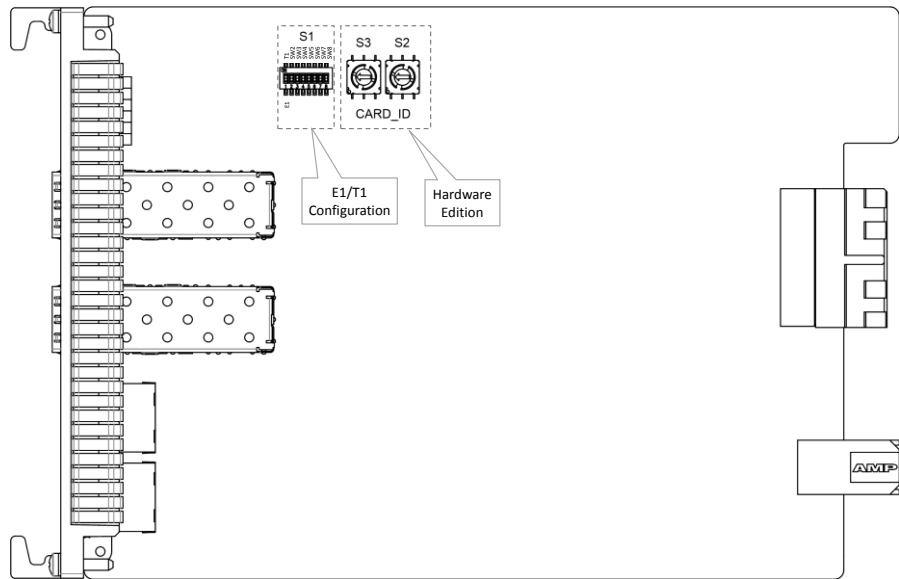

3. Take the 2-C37.94 module with the front panel handles, aim correctly and slide it through the correct card guides (see chapter §3.4) into the allocated slot.
4. Push the module as far as possible into the node.
5. Push firmly with your thumbs on the front panel for optimal backplane contact.
6. Tighten the two fastening screws.
7. Check whether the links are up via the LEDs, info on the LEDs via manuals listed in §15.
8. Call the control center to check whether the 2-C37.94 module is functioning properly after having it programmed in HiProvision.

### Program 2-C37.94 Module



A trained HiProvision administrator must perform the HiProvision steps below in the control center. A full description of the steps below can be found in 'Dragon PTN and HiProvision Operation' manual, see chapter 15.

1. Use your cell phone to communicate with the control center and ask them to program the 2-C37.94 in HiProvision.
2. In HiProvision, discover the network elements and links in the Dragon PTN Network.
3. In HiProvision, approve the Dragon PTN Network.
4. In HiProvision, configure all the network elements and links in the database. This could be done automatically via the discover and approve steps, or it can be done manually.
5. In HiProvision, program tunnels;
6. In HiProvision, program services;
7. Contact the control center to check if the 2-C37.94 is functioning properly after having it discovered and programmed in HiProvision.



## 2-C37.94 CABLING

The 2-C37.94 module provides two E1/T1 RJ-45 ports and each port connector has eight pins. Each port provides one tip/ring pair. See the table and figure below for an overview and description.

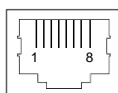

**E1 Cable (120  $\Omega$ ) 942 256-201**

**T1 Cable (100  $\Omega$ ) 942 256-200**

### Color Codes, Pin Numbers, Signal Names

Color	Signal Name	Pin Number
OG	Rx (Receive) RING	1
WH/OG	Rx (Receive) TIP	2
-	Not connected	3
BU	Tx (Transmit) RING	4
WH/BU	Tx (Transmit) TIP	5
-	Not connected	6
-	Not connected	7
-	Not connected	8

### 7.3 4-DSL-LW (942 236-007)

Engineer type	Section	Form: Installation of a 4-DSL-LW module
---------------	---------	---



#### ESD

With all installation activities, adopt the ESD recommendations regarding the handling, transportation and storage of modules. Find a full ESD description in chapter 18.

Duration:  
1 hour



*Always wear an antistatic wristband in direct contact with your skin. Connect the alligator clip to the blank metal of the rack or plug the antistatic wristband into the ESD bonding point.*

#### Installation Equipment

- ▶ Key of the rack (if necessary)
- ▶ Screwdriver set, cable ties and cable tool set
- ▶ Antistatic wristband
- ▶ 4-DSL-LW module
- ▶ Interface cable(s)
- ▶ Extra documentation can be found in chapter 15

#### Compatibility



**XT-1104-A/XT-2206-A/  
XT-2209-A/XT-2210-A**

Weight: approx. 0.25 kg  
/ 0.6 lb

#### Front Panel

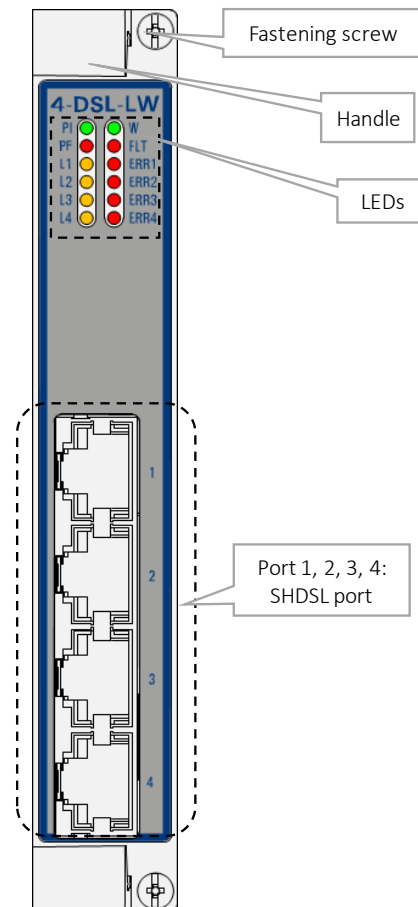

---

**Installation**

1. Remove the ESD packaging from the interface module, do not touch or bend the EMC spring on the side of the front panel.
  2. Identify the node and the interface slot where the module has to be installed, see corresponding node form.
  3. Take the 4-DSL-LW module with the front panel handles, aim correctly and slide it through the correct card guides (see chapter §3.4) into the allocated slot.
  4. Push the module as far as possible into the node.
  5. Push firmly with your thumbs on the front panel for optimal backplane contact.
  6. Tighten the two fastening screws.
  7. Plug the interface cable(s) into the corresponding connector(s) (see next page(s) for pin numbers, signal names and color codes).
-

Engineer type	Section	Form: Operation of a 4-DSL-LW module
---------------	---------	--------------------------------------



ESD

With all installation activities, adopt the ESD recommendations regarding the handling, transportation and storage of modules. Find a full ESD description in chapter 18.

Duration:  
10 min.



*Always wear an antistatic wristband in direct contact with your skin. Connect the alligator clip to the blank metal of the rack or plug the antistatic wristband into the ESD bonding point.*

### Installation Equipment

- ▶ Key of the rack (if necessary)
- ▶ Screwdriver set, cable ties and cable tool set
- ▶ Antistatic wristband
- ▶ Extra documentation can be found in chapter 15

### Operation

1. Un-tighten the screws on the 4-DSL-LW module and remove the module from the node (module = hot-swappable), do not touch or bend the EMC spring on the side of the front panel
2. Set the 'Device Mode Configuration' DIP-switch S1, see section below for more information.

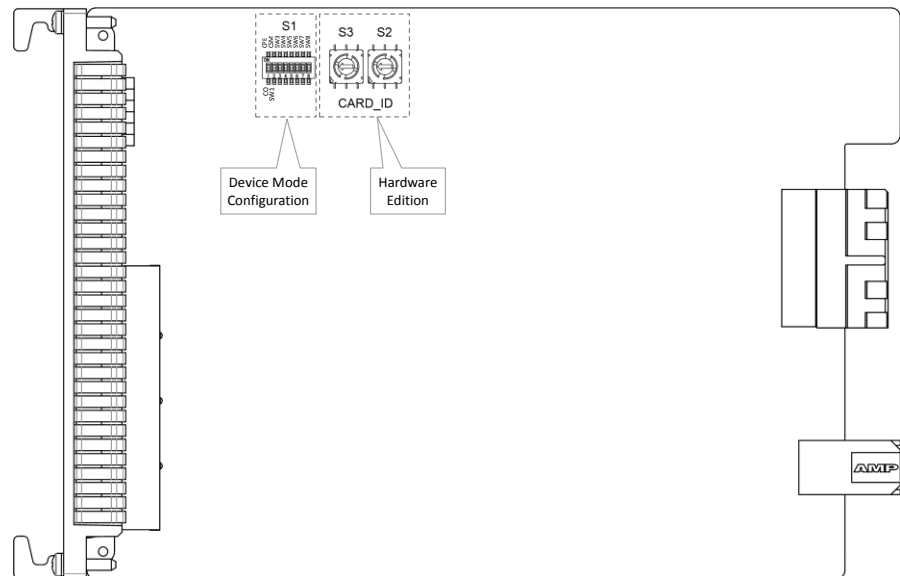

3. Take the 4-DSL-LW module with the front panel handles, aim correctly and slide it through the correct card guides (see chapter §3.4) into the allocated slot.
4. Push the module as far as possible into the node.
5. Push firmly with your thumbs on the front panel for optimal backplane contact.
6. Tighten the two fastening screws.
7. Check whether the links are up via the LEDs, info on the LEDs via manuals listed in §15.
8. Call the control center to check whether the 4-DSL-LW module is functioning properly after having it programmed in HiProvision.

---

**Program  
4-DSL-LW  
Module**



A trained HiProvision administrator must perform the HiProvision steps below in the control center. A full description of the steps below can be found in 'Dragon PTN and HiProvision Operation' manual, see chapter 15.

---

1. Use your cell phone to communicate with the control center and ask them to program the 4-DSL-LW in HiProvision.
  2. In HiProvision, discover the network elements and links in the Dragon PTN Network.
  3. In HiProvision, approve the Dragon PTN Network.
  4. In HiProvision, configure all the network elements and links in the database. This could be done automatically via the discover and approve steps, or it can be done manually.
  5. In HiProvision, program tunnels;
  6. In HiProvision, program services;
  7. Contact the control center to check if the 4-DSL-LW is functioning properly after having it discovered and programmed in HiProvision.
- 

**Device Mode  
(CO/CPE)  
Configuration**

CO = Central Office

CPE = Customer Premises Equipment

The 'Device Mode' (CO or CPE) of the 4-DSL-LW module depends on the configuration in HiProvision and the S1 DIP switch settings. The figure below shows this DIP switch into detail.

The 'Device Mode' configuration in HiProvision (=Dragon PTN Management System) will always be the master setting. In HiProvision, configure the 'Unit Type' parameter on IFM level as follows:

- ▶ CO: Unit Type = 'LT Unit'; (LT = Line Termination);
- ▶ CPE: Unit Type = 'NT Unit'; (NT = Network Termination);

Only when there is nothing configured in HiProvision for this IFM, the S1 DIP switch settings come into play. The possible configurations of this S1 DIP switch are shown in the table below.

**NOTE:** Other switches on the S1 DIP switch are spare switches.

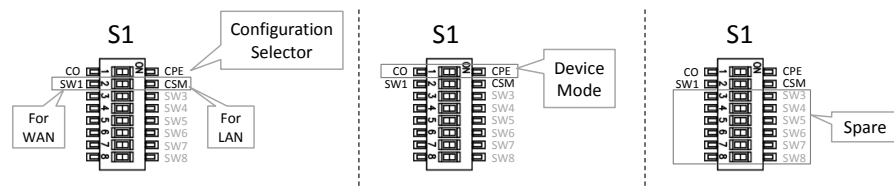

Switch: Configuration Selector	Switch: Device Mode	Description
SW1 (=default) (for WAN=future)	CO (=default)	The Device Mode will be as configured in HiProvision. If nothing has been configured yet in HiProvision, the Device Mode will fall back to the Device Mode switch setting on the board and start up as CO. As a result, the SHDSL link can come up spontaneously, if the other SHDSL link partner is CPE. This behavior is required in the discovery phase of a new network or node when the nodes are interconnected via a WAN SHDSL link.
	CPE	The Device Mode will be as configured in HiProvision. If no configuration has been done in HiProvision, the Device Mode will fall back to the Device Mode switch setting on the board and start up as CPE. As a result, the SHDSL link can come up spontaneously, if the other SHDSL link partner is CO. This behavior is required in the discovery phase of a new network or node when the nodes are interconnected via a WAN SHDSL link.
CSM (for LAN)	CO (=default)	The Device Mode will be as configured in HiProvision (=CSM is driven by HiProvision). If no configuration has been done in HiProvision yet, the 4-DSL-LW module will start up UNCONFIGURED and the LAN SHDSL link will not come up! The module will not be operational and just wait for a configuration in HiProvision. This behavior is required for LAN SHDSL links because the HiProvision operator only wants the link to come up in a controlled way.
	CPE	

#### 4-DSL-LW CABLING

##### For the Ethernet ports following cables can be used:

- ▶ 10 Base-T: 2-pair UTP/STP Cat. 3, 4, 5e or 6 cable, EIA/TIA-568 100-ohm (100m)
- ▶ 100 Base-TX: 2-pair UTP/STP Cat. 5e or 6 cable, EIA/TIA-568 100-ohm (100m)

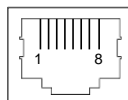

The SHDSL RJ-45 connector on the front panel has 8 pins and only the two middle pins (pin 4 and 5) are used. See below for an overview and description.



#### 4-DSL-LW RJ-45 Connector: Pin Assignments

Pin Number	Description
1,2,3	Not Used
4	Data Pair1 Tip (+), including wetting current if configured in HiProvision
5	Data Pair1 Ring (-), including wetting current if configured in HiProvision
6,7,8	Not Used

## 7.4 4-E1-L/4-T1-L (942 236-010/ 942 236-011)

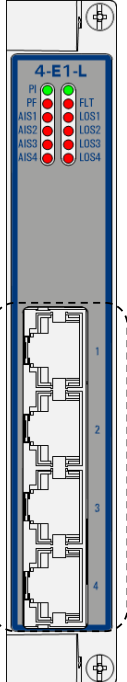
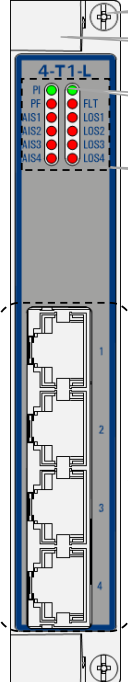
Engineer type	Section	Form: Installation of a 4-E1-L/4-T1-L module	
 <p>Duration: 1 hour</p>	<p><b>ESD</b></p>	<p>With all installation activities, adopt the ESD recommendations regarding the handling, transportation and storage of modules. Find a full ESD description in chapter 18.</p> 	<p><i>Always wear an antistatic wristband in direct contact with your skin. Connect the alligator clip to the blank metal of the rack or plug the antistatic wristband into the ESD bonding point.</i></p>
<p><b>Installation Equipment</b></p>		<ul style="list-style-type: none"> <li>▶ Key of the rack (if necessary)</li> <li>▶ Screwdriver set, cable ties and cable tool set</li> <li>▶ Antistatic wristband</li> <li>▶ 4-E1-L/4-T1-L module</li> <li>▶ Interface cable(s)</li> <li>▶ Extra documentation can be found in chapter 15</li> </ul>	
<p><b>Compatibility</b></p>		<p><b>XT-1104-A/XT-2206-A/ XT-2209-A/XT-2210-A</b></p>	<p>Weight: approx. 0.27 kg / 0.6 lb</p>
<p><b>Front Panel</b></p>			
<p><b>Installation</b></p>		<ol style="list-style-type: none"> <li>1. Remove the ESD packaging from the interface module, do not touch or bend the EMC spring on the side of the front panel.</li> <li>2. Identify the node and the interface slot where the module has to be installed, see corresponding node form.</li> <li>3. Take the 4-E1-L/4-T1-L module with the front panel handles, aim correctly and slide it through the correct card guides (see chapter §3.4) into the allocated slot.</li> </ol>	

4. Push the module as far as possible into the node.
5. Push firmly with your thumbs on the front panel for optimal backplane contact.
6. Tighten the two fastening screws.
7. Plug the interface cable(s) into the corresponding connector(s) (see next page(s) for pin numbers, signal names and color codes).

Engineer type	Section	Form: Operation of a 4-E1-L/4-T1-L module
---------------	---------	---



**ESD**

With all installation activities, adopt the ESD recommendations regarding the handling, transportation and storage of modules. Find a full ESD description in chapter 18.

Duration:  
10 min.



*Always wear an antistatic wristband in direct contact with your skin. Connect the alligator clip to the blank metal of the rack or plug the antistatic wristband into the ESD bonding point.*

**Installation Equipment**

- ▶ Key of the rack (if necessary)
- ▶ Screwdriver set, cable ties and cable tool set
- ▶ Antistatic wristband
- ▶ Extra documentation can be found in chapter 15

**Operation**

1. Un-tighten the screws on the 4-E1-L/4-T1-L module and remove the module from the node (module = hot-swappable), do not touch or bend the EMC spring on the side of the front panel.
2. The E1/T1 configuration of the 4-E1-L/4-T1-L module is factory set by the S1 DIP switch and must not be changed. The configuration can be read out via HiProvision.

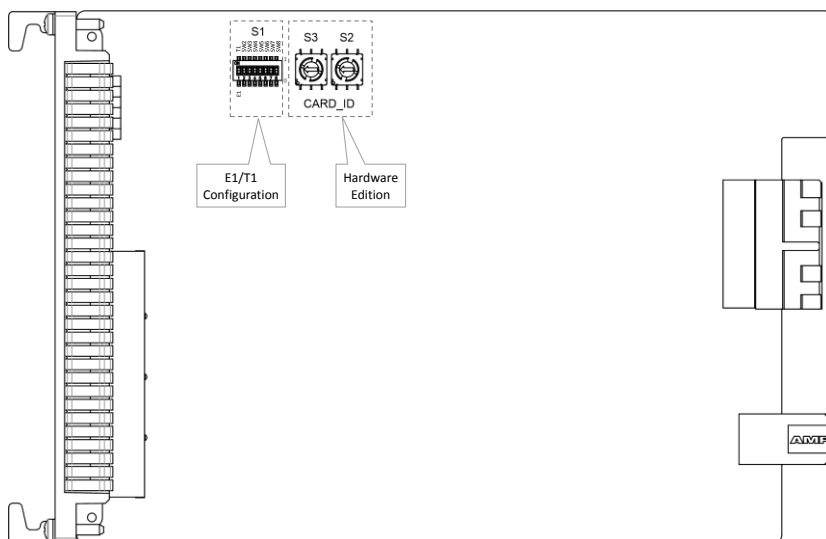



- 
3. Take the 4-E1-L/4-T1-L module with the front panel handles, aim correctly and slide it through the correct card guides (see chapter §3.4) into the allocated slot.
  4. Push the module as far as possible into the node.
  5. Push firmly with your thumbs on the front panel for optimal backplane contact.
  6. Tighten the two fastening screws.
  7. Check whether the links are up via the LEDs, info on the LEDs via manuals listed in §15.
  8. Call the control center to check whether the 4-E1-L/4-T1-L module is functioning properly after having it programmed in HiProvision.

---

**Program  
4-E1-L/4-T1-L  
Module**



A trained HiProvision administrator must perform the HiProvision steps below in the control center. A full description of the steps below can be found in 'Dragon PTN and HiProvision Operation' manual, see chapter 15.

- 
1. Use your cell phone to communicate with the control center and ask them to program the 4-E1-L/4-T1-L in HiProvision.
  2. In HiProvision, discover the network elements and links in the Dragon PTN Network.
  3. In HiProvision, approve the Dragon PTN Network.
  4. In HiProvision, configure all the network elements and links in the database. This could be done automatically via the discover and approve steps, or it can be done manually.
  5. In HiProvision, program tunnels;
  6. In HiProvision, program services;
  7. Contact the control center to check if the 4-E1-L/4-T1-L is functioning properly after having it discovered and programmed in HiProvision.
-

## 4-E1-L/4-T1-L CABLING

The 4-E1-L/4-T1-L module provides four E1/T1 RJ-45 ports and each port connector has eight pins. Each port provides one tip/ring pair. See the table and figure below for an overview and description.

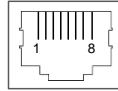



**E1 Cable (120  $\Omega$ ) 942 256-201**

**T1 Cable (100  $\Omega$ ) 942 256-200**

### Color Codes, Pin Numbers, Signal Names

Color	Signal Name	Pin Number
OG	Rx (Receive) RING	1
WH/OG	Rx (Receive) TIP	2
-	Not connected	3
BU	Tx (Transmit) RING	4
WH/BU	Tx (Transmit) TIP	5
-	Not connected	6
-	Not connected	7
-	Not connected	8

## 7.5 16-E1-L/16-T1-L (942 236-012/942 236-013)

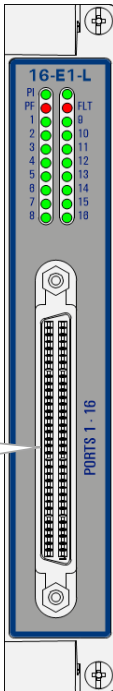
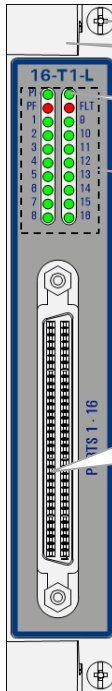
Engineer type	Section	Form: Installation of a 16-E1-L/16-T1-L module
 <p>Duration: 1 hour</p>	<p><b>ESD</b></p>	<p>With all installation activities, adopt the ESD recommendations regarding the handling, transportation and storage of modules. Find a full ESD description in chapter 18.</p> <div style="display: flex; align-items: center; justify-content: center;">  <p><i>Always wear an antistatic wristband in direct contact with your skin. Connect the alligator clip to the blank metal of the rack or plug the antistatic wristband into the ESD bonding point.</i></p> </div>
<p><b>Installation Equipment</b></p>		<ul style="list-style-type: none"> <li>▶ Key of the rack (if necessary)</li> <li>▶ Screwdriver set, cable ties and cable tool set</li> <li>▶ Antistatic wristband</li> <li>▶ 16-E1-L/16-T1-L module</li> <li>▶ Interface cable(s) + RJ45 couplers + Patch panel</li> <li>▶ Extra documentation can be found in chapter 15</li> </ul>
<p><b>Compatibility</b></p>	<p></p>	<p><b>XT-1104-A/XT-2206-A/ XT-2209-A/XT-2210-A</b>      Weight: approx. 0.25 kg / 0.6 lb</p>
<p><b>Front Panel</b></p>		<div style="display: flex; justify-content: space-around; align-items: center;"> <div style="text-align: center;">  <p>HPDB68 Connector: Ports 1...16: E1 ports</p> </div> <div style="text-align: center;">  <p>HPDB68 Connector: Ports 1...16: T1 ports</p> </div> </div> <div style="margin-top: 10px;"> <p>Fastening screw</p> <p>Handle</p> <p>Spare LED</p> <p>LEDs</p> </div>
<p><b>Installation</b></p>		<ol style="list-style-type: none"> <li>1. Remove the ESD packaging from the interface module, do not touch or bend the EMC spring on the side of the front panel.</li> <li>2. Identify the node and the interface slot where the module has to be installed, see corresponding node form.</li> <li>3. Take the 16-E1-L/16-T1-L module with the front panel handles, aim correctly and slide it through the correct card guides (see chapter §3.4) into the allocated slot.</li> </ol>

4. Push the module as far as possible into the node.
5. Push firmly with your thumbs on the front panel for optimal backplane contact.
6. Tighten the two fastening screws.
7. Plug the interface cable into the corresponding connector (see next page(s) for pin numbers, signal names and color codes).
8. For the connection of the interface cable with the end devices, there are several possibilities. See '16-E1-L/16-T1-L Cabling' section below for more details.

Engineer type	Section	Form: Operation of a 16-E1-L/16-T1-L module
---------------	---------	---



Duration:  
10 min.

**ESD**

With all installation activities, adopt the ESD recommendations regarding the handling, transportation and storage of modules. Find a full ESD description in chapter 18.



*Always wear an antistatic wristband in direct contact with your skin. Connect the alligator clip to the blank metal of the rack or plug the antistatic wristband into the ESD bonding point.*

**Installation Equipment**

- ▶ Key of the rack (if necessary)
- ▶ Screwdriver set, cable ties and cable tool set
- ▶ Antistatic wristband
- ▶ Extra documentation can be found in chapter 15

**Operation**

9. The 16-E1-L/16-T1-L module does not require any settings, straps or adjustments prior to the installation.
10. The E1/T1 configuration of 16-E1-L/16-T1-L module is factory set. The configuration can be read out via HiProvision.
11. Check whether the links are up via the LEDs, info on the LEDs via manuals listed in §15.
12. Call the control center to check whether the 16-E1-L/16-T1-L module is functioning properly after having it programmed in HiProvision.

**Program 16-E1-L/16-T1-L Module**



A trained HiProvision administrator must perform the HiProvision steps below in the control center. A full description of the steps below can be found in 'Dragon PTN and HiProvision Operation' manual, see chapter 15.

1. Use your cell phone to communicate with the control center and ask them to program the 16-E1-L/16-T1-L in HiProvision.
2. In HiProvision, discover the network elements and links in the Dragon PTN Network.

3. In HiProvision, approve the Dragon PTN Network.
4. In HiProvision, configure all the network elements and links in the database. This could be done automatically via the discover and approve steps, or it can be done manually.
5. In HiProvision, program tunnels;
6. In HiProvision, program services;
7. Contact the control center to check if the 16-E1-L/16-T1-L is functioning properly after having it discovered and programmed in HiProvision.

### 16-E1-L/16-T1-L CABLING

The 16-E1-L/16-T1-L module provides 16 E1/T1 ports via a HPDB68 connector. Each port provides one tip/ring pair. Connections to this IFM can be made in following ways:

- ▶ Via a drop cable (2m) HPDB68 to 16 RJ-45 with RJ-45 couplers together with the 24 ports feedthrough patch panel. Each RJ-45 port connector has eight pins which provides one tip/ring pair. E1/T1 cables must be used to connect these ports;
- ▶ Via a drop cable (2m) HPDB68 to 16 RJ-45 with a 16 ports RJ-45 to BNC-coax patch panel. Each RJ-45 port connector has eight pins which provides one tip/ring pair. Coax cables must be used to connect these ports;
- ▶ Via a drop cable (1.5m) HPDB68 to open end which can be wired later on to punch-down connectors. These punch-down-connectors must be provided by the customer.
- ▶ See the table and figures below for an overview and description of the different connections, connectors and pin assignments.

Description	Ordering Number
Drop cable (2m) HPDB68 to 16 RJ-45 with RJ-45 coupler	942 256-203
Patch panel 1 U feedthrough 24 ports (to be used in combo with C30965-A9550-D11)	942 256-204
E1 cable (120 Ω)	942 256-201
T1 cable (100 Ω)	942 256-200
Drop cable (2m) HPDB68 to 16 RJ-45 with 16 ports RJ-45 to BNC-Coax patch panel	942 256-205
Drop cable (1.5m) HPDB68 to open end	942 256-202

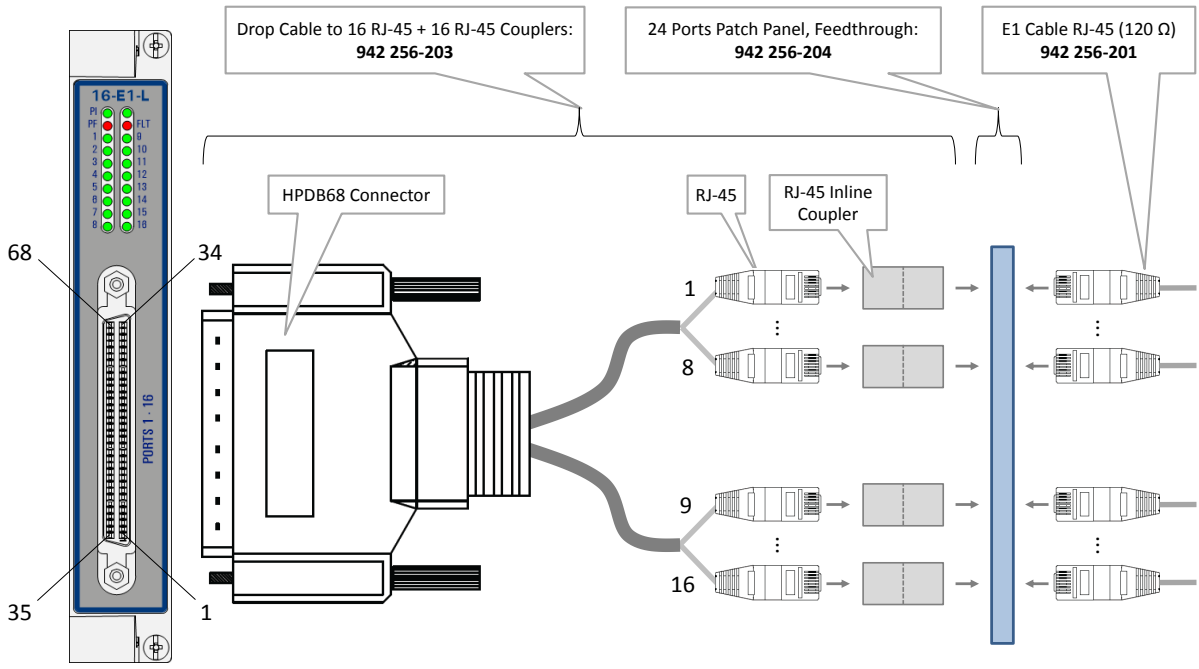

Drop Cable to RJ-45 Connection Unplugged

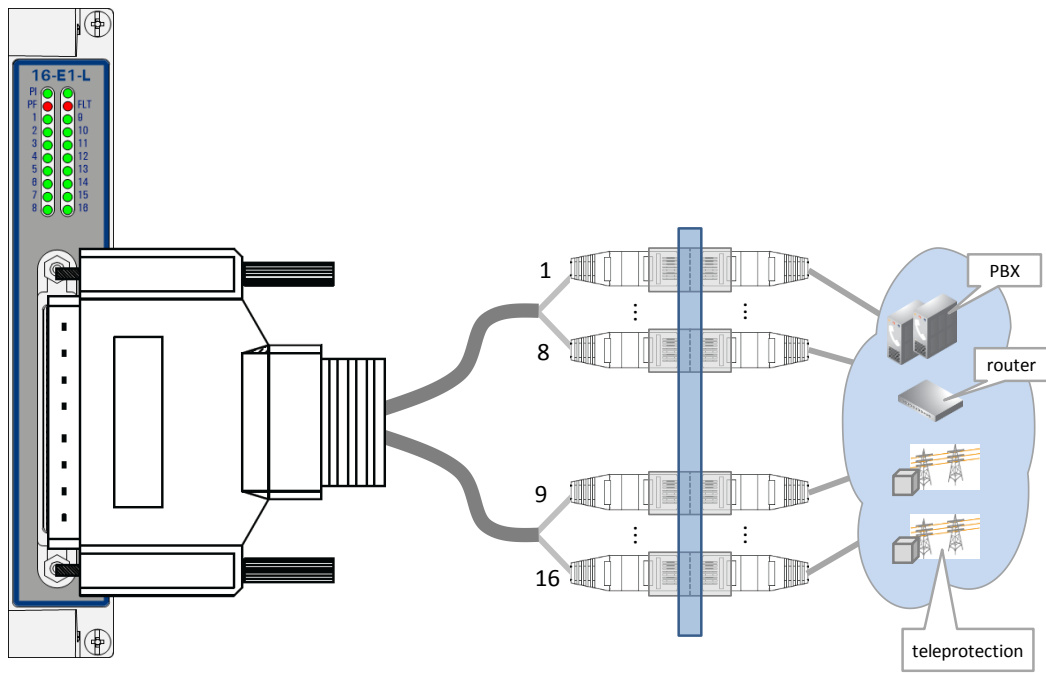

Drop Cable to RJ-45 Connection Plugged

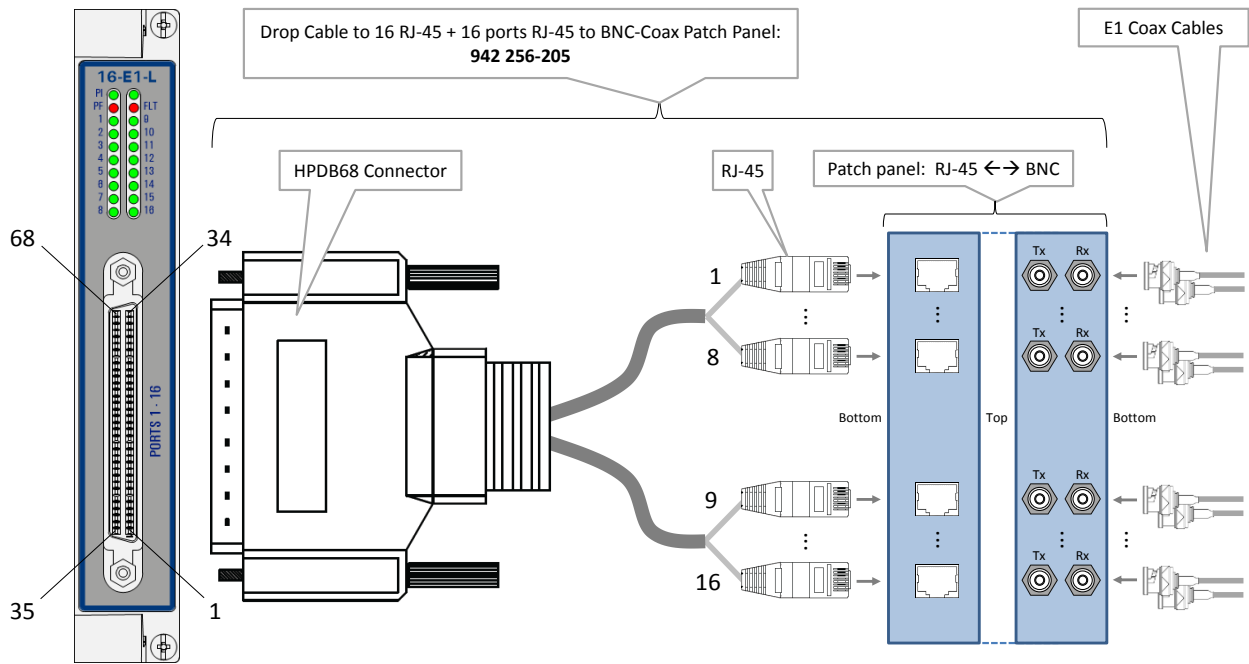

### Drop Cable via RJ-45 to BNC-Coax Connection Unplugged

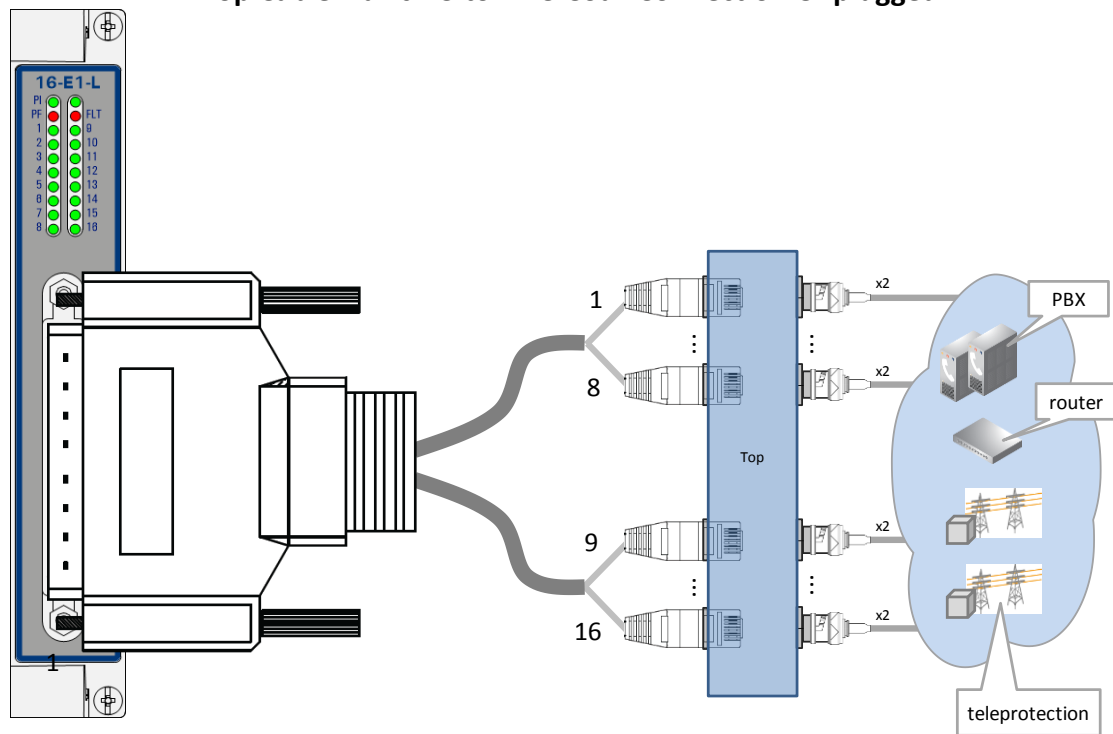

### Drop Cable via RJ-45 to BNC-Coax Connection Plugged

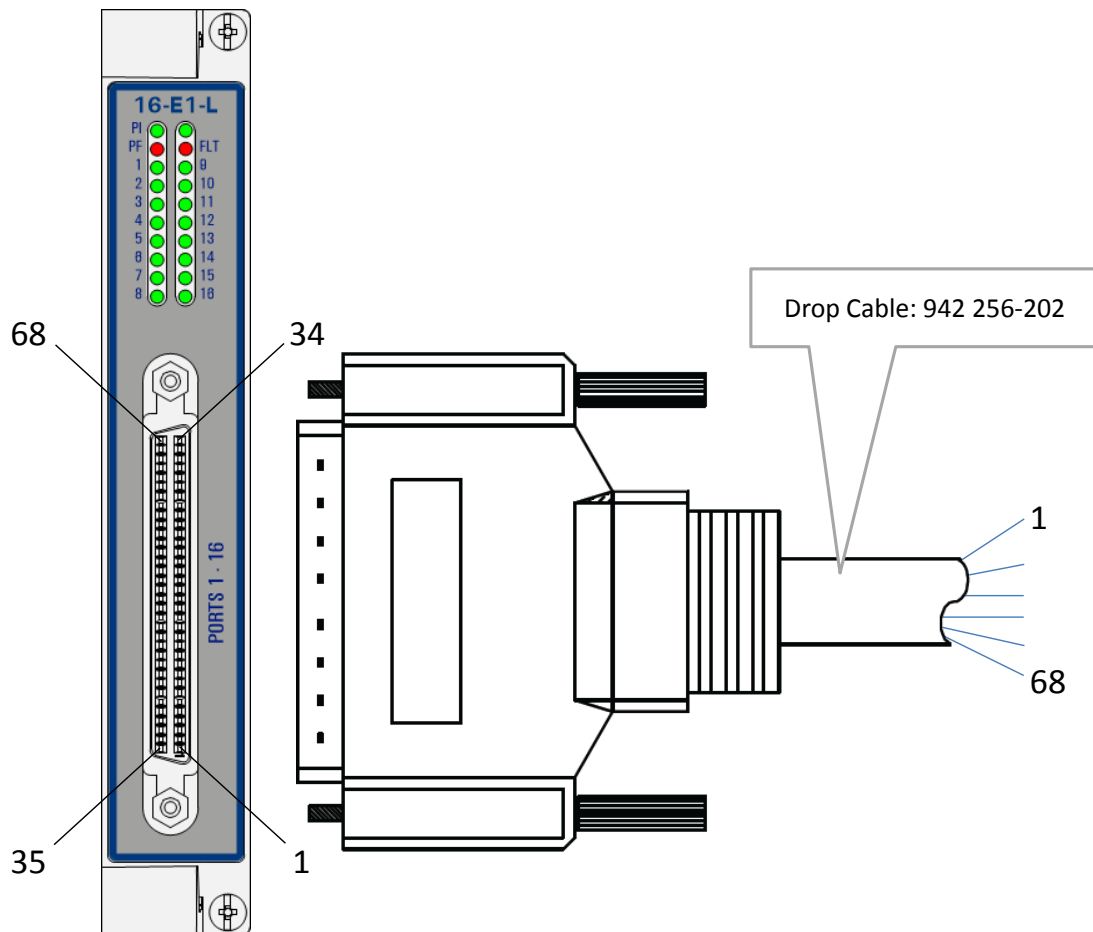

**Drop Cable (1.5m) HPDB68 to Open End**

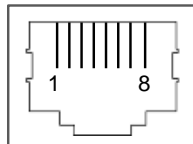

**E1/T1 RJ-45 Cable Connector**

**E1/T1 RJ-45 Cable Connector: Pin Assignments**

Pin Number	Description	Cable Wire Colors
1	Rx (Receive) RING	OG
2	Rx (Receive) TIP	WH/OG
3	Not connected	-
4	Tx (Transmit) RING	BU
5	Tx (Transmit) TIP	WH/BU
6, 7, 8	Not connected	-



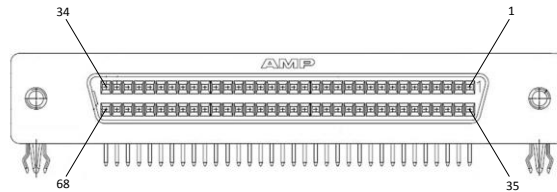



**HPDB68 Connector**

**HPDB68 Connector - Drop Cable: Pin Assignments**



Pin No.	Cable Wire Color	E1/T1 Port			Pin No.	Cable Wire Color	E1/T1 Port		
		No.	(RJ-45) Pin No.	Signal (*)			No.	(RJ-45) Pin No.	Signal (*)
1	Black	/	/	/	35	Dark yellow	/	/	/
1	Black	/	/	/	35	Dark yellow	/	/	/
2	Black / white	/	/	/	36	Dark yellow / black	/	/	/
3	Light brown	16	2	R_TIP_P16	37	Grey	16	1	R_RING_P16
4	Light brown / red	16	5	T_TIP_P16	38	Grey / black	16	4	T_RING_P16
5	Green	15	2	R_TIP_P15	39	Red	15	1	R_RING_P15
6	Green / black	15	5	T_TIP_P15	40	Red / black	15	4	T_RING_P15
7	Blue	14	2	R_TIP_P14	41	Purple	14	1	R_RING_P14
8	Blue / white	14	5	T_TIP_P14	42	Purple / white	14	4	T_RING_P14
9	Light blue	13	2	R_TIP_P13	43	Pink	13	1	R_RING_P13
10	Light blue / black	13	5	T_TIP_P13	44	Pink / black	13	4	T_RING_P13
11	Brown	12	2	R_TIP_P12	45	White	12	1	R_RING_P12
12	Brown / white	12	5	T_TIP_P12	46	White / black	12	4	T_RING_P12
13	Orange	11	2	R_TIP_P11	47	Light green	11	1	R_RING_P11
14	Orange / black	11	5	T_TIP_P11	48	Light green / black	11	4	T_RING_P11
15	Yellow	10	2	R_TIP_P10	49	Blue / Red	10	1	R_RING_P10
16	Yellow / red	10	5	T_TIP_P10	50	Purple / Red	10	4	T_RING_P10
17	Grey / red	9	2	R_TIP_P9	51	Purple / blue	9	1	R_RING_P9
18	Grey / blue	9	5	T_TIP_P9	52	Purple / green	9	4	T_RING_P9
19	Light green / blue	8	2	R_TIP_P8	53	Light blue / red	8	1	R_RING_P8
20	Green / white	8	5	T_TIP_P8	54	Light blue / blue	8	4	T_RING_P8
21	Light green / red	7	2	R_TIP_P7	55	Pink / red	7	1	R_RING_P7
22	Green / blue	7	5	T_TIP_P7	56	Pink / blue	7	4	T_RING_P7
23	Grey / yellow	6	2	R_TIP_P6	57	Yellow / white	6	1	R_RING_P6
24	Grey / green	6	5	T_TIP_P6	58	Yellow/ black	6	4	T_RING_P6
25	Red / white	5	2	R_TIP_P5	59	Yellow/ blue	5	1	R_RING_P5
26	Red / blue	5	5	T_TIP_P5	60	Yellow/ green	5	4	T_RING_P5
27	White / red	4	2	R_TIP_P4	61	Dark yellow/ red	4	1	R_RING_P4
28	White / blue	4	5	T_TIP_P4	62	Dark yellow/ blue	4	4	T_RING_P4
29	Pink / white	3	2	R_TIP_P3	63	White/ yellow	3	1	R_RING_P3
30	Pink / orange	3	5	T_TIP_P3	64	White / green	3	4	T_RING_P3
31	Light blue / yellow	2	2	R_TIP_P2	65	Light green / yellow	2	1	R_RING_P2
32	Light blue / green	2	5	T_TIP_P2	66	Light green / green	2	4	T_RING_P2
33	Orange / red	1	2	R_TIP_P1	67	Orange / white	1	1	R_RING_P1
34	Orange / green	1	5	T_TIP_P1	68	Grey / white	1	4	T_RING_P1

(\*) R = Receive / T = Transmit

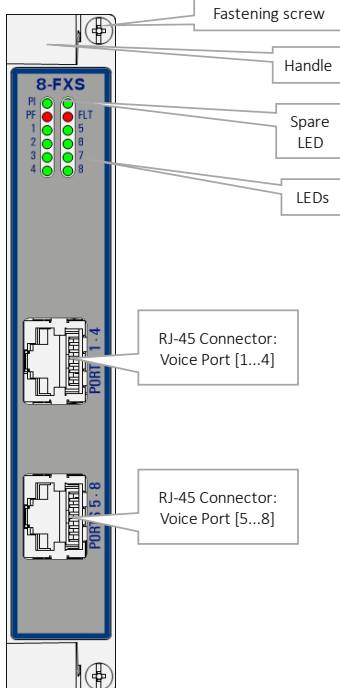
## 7.6 8-FXS (future support)

Engineer type	Section	Form: Installation of a 8-FXS module
 <p>Duration: 1 hour</p>	<p><b>ESD</b></p>	<p>With all installation activities, adopt the ESD recommendations regarding the handling, transportation and storage of modules. Find a full ESD description in chapter 18.</p> <div style="display: flex; align-items: center;">  <p><i>Always wear an antistatic wristband in direct contact with your skin. Connect the alligator clip to the blank metal of the rack or plug the antistatic wristband into the ESD bonding point.</i></p> </div>
<p><b>Installation Equipment</b></p>		<ul style="list-style-type: none"> <li>▶ Key of the rack (if necessary)</li> <li>▶ Screwdriver set, cable ties and cable tool set</li> <li>▶ Antistatic wristband</li> <li>▶ 8-FXS module</li> <li>▶ Interface cable(s) + RJ11 couplers + Patch panel</li> <li>▶ Extra documentation can be found in chapter 15</li> </ul>
<p><b>Compatibility</b></p>	<p style="text-align: center;"></p>	<p style="text-align: center;"><b>XT-1104-A/XT-2206-A/ XT-2209-A/XT-2210-A</b></p> <p style="text-align: right;">Weight: approx. 0.23 kg / 0.5 lb</p>
<p><b>Front Panel</b></p>		
<p><b>Installation</b></p>		<ol style="list-style-type: none"> <li>1. Remove the ESD packaging from the interface module, do not touch or bend the EMC spring on the side of the front panel.</li> <li>2. Identify the node and the interface slot where the module has to be installed, see corresponding node form.</li> <li>3. Take the 8-FXS module with the front panel handles, aim correctly and slide it through the correct card guides (see chapter §3.4) into the allocated slot.</li> </ol>

4. Push the module as far as possible into the node.
5. Push firmly with your thumbs on the front panel for optimal backplane contact.
6. Tighten the two fastening screws.
7. Plug the interface cable into the corresponding connector (see next page(s) for pin numbers, signal names and color codes).
8. For the connection of the interface cable with the end devices, there are several possibilities. See '8-FXS Cabling' section below for more details.

Engineer type	Section	Form: Operation of a 8-FXS module
 <p>Duration: 10 min.</p>	<p><b>ESD</b></p>	<p>With all installation activities, adopt the ESD recommendations regarding the handling, transportation and storage of modules. Find a full ESD description in chapter 18.</p> <div style="display: flex; align-items: center;">  <p><i>Always wear an antistatic wristband in direct contact with your skin. Connect the alligator clip to the blank metal of the rack or plug the antistatic wristband into the ESD bonding point.</i></p> </div>
	<p><b>Installation Equipment</b></p>	<ul style="list-style-type: none"> <li>▶ Key of the rack (if necessary)</li> <li>▶ Screwdriver set, cable ties and cable tool set</li> <li>▶ Antistatic wristband</li> <li>▶ Extra documentation can be found in chapter 15</li> </ul>
	<p><b>Operation</b></p>	<ol style="list-style-type: none"> <li>1. The 8-FXS module does not require any settings, straps or adjustments prior to the installation.</li> <li>2. Check whether the links are up via the LEDs, info on the LEDs via manuals listed in §15.</li> <li>3. Call the control center to check whether the 8-FXS module is functioning properly after having it programmed in HiProvision.</li> </ol>
	<p><b>Program 8-FXS Module</b></p>	<div style="display: flex; align-items: center;">  <p>A trained HiProvision administrator must perform the HiProvision steps below in the control center. A full description of the steps below can be found in 'Dragon PTN and HiProvision Operation' manual, see chapter 15.</p> </div> <ol style="list-style-type: none"> <li>1. Use your cell phone to communicate with the control center and ask them to program the 8-FXS in HiProvision.</li> <li>2. In HiProvision, discover the network elements and links in the Dragon PTN Network.</li> <li>3. In HiProvision, approve the Dragon PTN Network.</li> </ol>

4. In HiProvision, configure all the network elements and links in the database. This could be done automatically via the discover and approve steps, or it can be done manually.
5. In HiProvision, program tunnels;
6. In HiProvision, program services;
7. Contact the control center to check if the 8-FXS is functioning properly after having it discovered and programmed in HiProvision.

## 8-FXS CABLING

The 8-FXS module provides 8 analog voice ports via 2 RJ-45 connectors, each connector providing 4 ports. Each port provides one tip/ring pair. Connections to this IFM can be made via a connection kit that can be plugged as well in a patch panel:

- ▶ 8-FXS Connection Kit (future support) includes:
  - ▶ An RJ-45 drop cable (1.5m) wired out on 4\*RJ-11 couplers to connect ports [1..4];
  - ▶ An RJ-45 drop cable (1.5m) wired out on 4\*RJ-11 couplers to connect ports [5..8];
- ▶ Patch panel (order no. 942 256-204):
  - ▶ 24 ports feedthrough patch panel. The RJ-45 drop cables from the connection kit can be plugged into this patch panel.
  - ▶ Analog telephony RJ11 cables must be plugged into the RJ-11 couplers to connect to the 8-FXS ports;
- ▶ See the table and figures below for an overview and description of the different connections, connectors and pin assignments.

Description	Ordering Number
8-FXS Connection Kit	future support
Patch panel 1 U feedthrough 24 ports (to be used in combo with the 8-FXS Connection Kit)	942 256-204

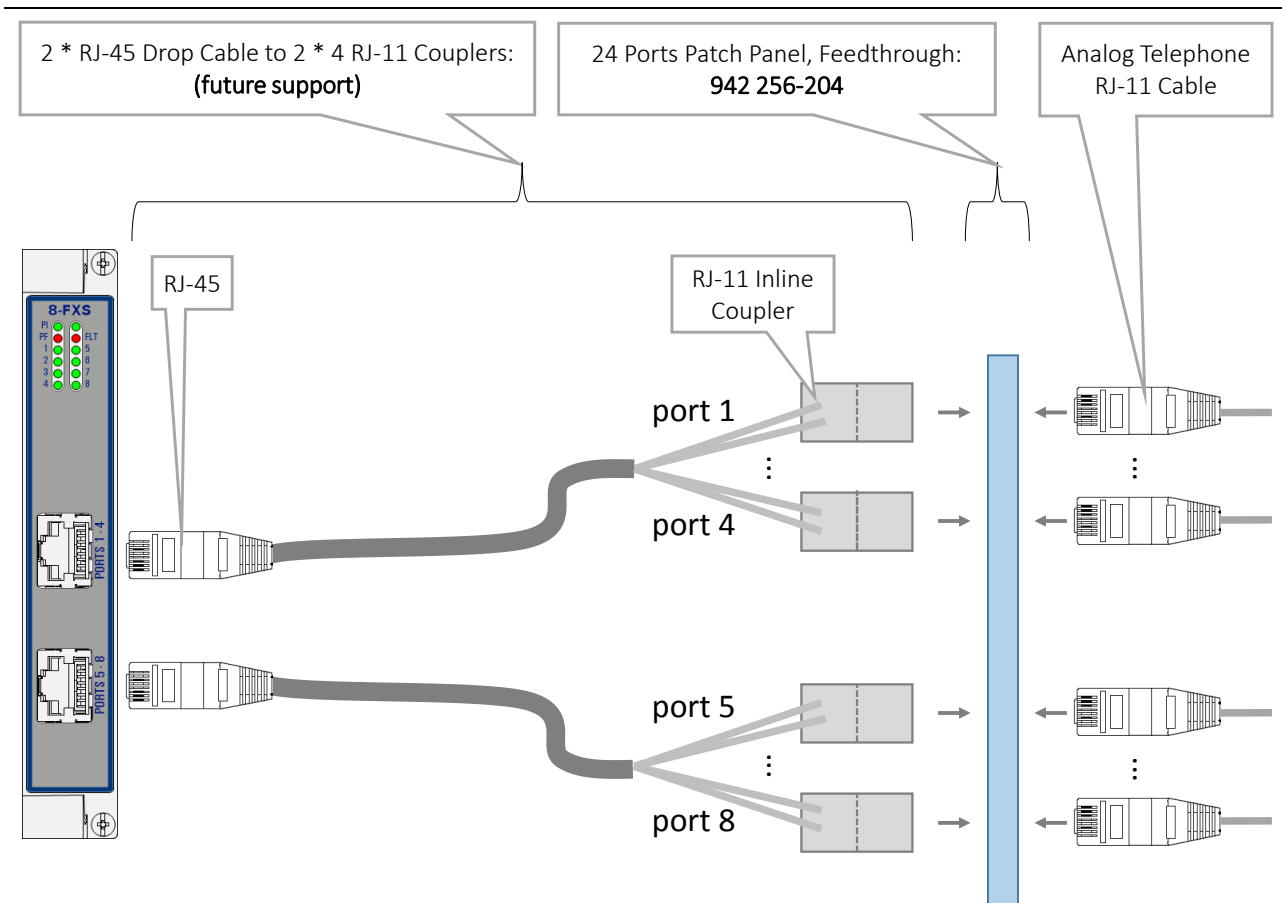

**8-FXS Connection: Unplugged**

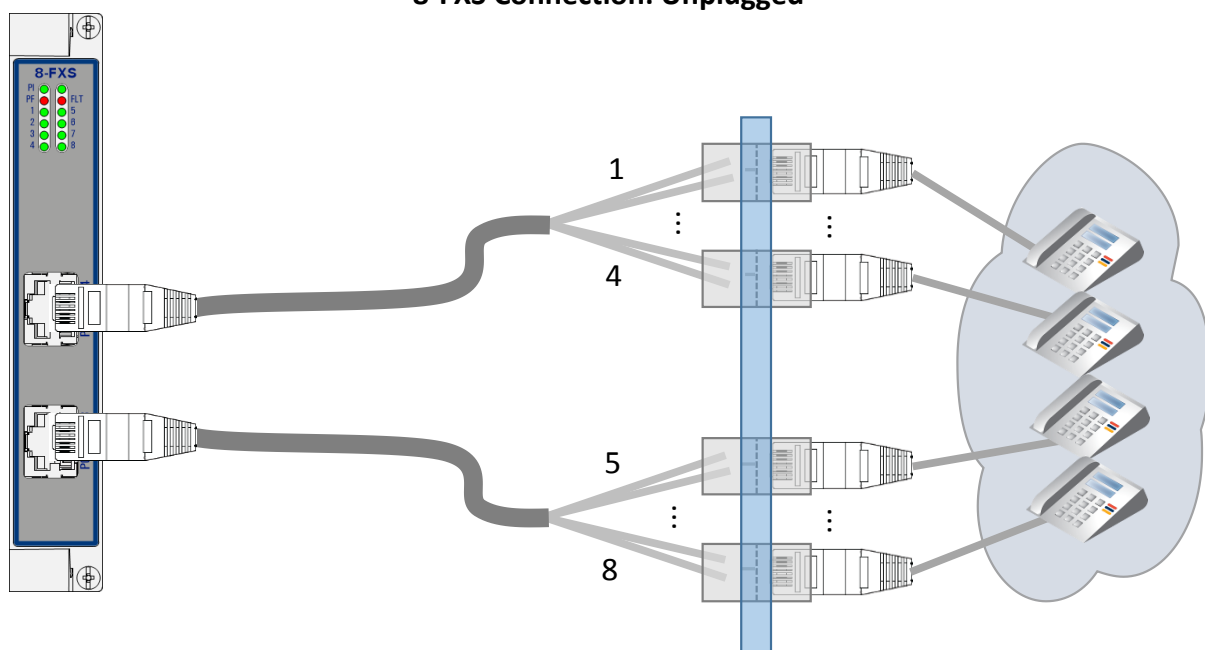

**8-FXS Connection: Plugged**

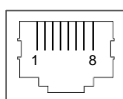

**8-FXS RJ-45 Connector**

### 8-FXS RJ-45 Cable-Coupler: Pin Assignments

8-FXS RJ45 Connector Cable				Coupler		
Port No.	Pin No.	Description	Wire Colors	Coupler No.	Pin No.	Color
1	1	TIP1	white/orange	1	2	Green
	2	RING1	orange		3	White Blue
2	3	TIP2	white/green	2	2	Green
	6	RING2	green		3	White Blue
3	4	TIP3	blue	3	2	Green
	5	RING3	white/blue		3	White Blue
4	7	TIP4	white/brown	4	2	Green
	8	RING4	brown		3	White Blue
5	1	TIP5	white/orange	5	2	Green
	2	RING5	orange		3	White Blue
6	3	TIP6	white/green	6	2	Green
	6	RING6	green		3	White Blue
7	4	TIP7	blue	7	2	Green
	5	RING7	white/blue		3	White Blue
8	7	TIP8	white/brown	8	2	Green
	8	RING8	brown		3	White Blue

## 7.7 4-GC-LW (942 236-001), 4-GCB-LW (942 236-008)

Engineer type	Section	Form: Installation of a 4-GC-LW/4-GCB-LW module
---------------	---------	---



### ESD

With all installation activities, adopt the ESD recommendations regarding the handling, transportation and storage of modules. Find a full ESD description in chapter 18.

Duration:  
1 hour



*Always wear an antistatic wristband in direct contact with your skin. Connect the alligator clip to the blank metal of the rack or plug the antistatic wristband into the ESD bonding point.*

### Installation Equipment

- ▶ Key of the rack (if necessary)
- ▶ Screwdriver set, cable ties, cable tool set and Fiber cleaning tool
- ▶ Antistatic wristband
- ▶ 4-GC-LW/4-GCB-LW module + SFP module
- ▶ Interface cable(s) and fiber optic patch cords
- ▶ Extra documentation can be found in chapter 15

### Compatibility



**XT-1104-A/XT-2206-A/  
XT-2209-A/XT-2210-A**

Weight: approx. 0.25 kg /  
0.6 lb

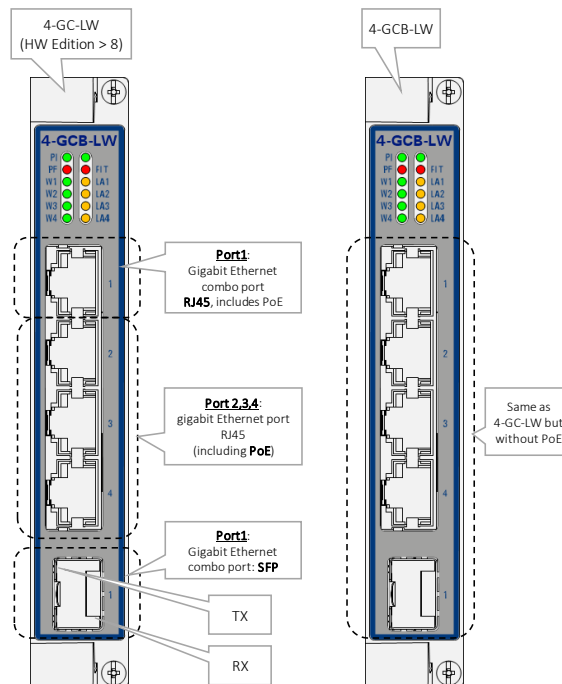

### Front Panel



### Installation

1. Remove the ESD packaging from the interface module, do not touch or bend the EMC spring on the side of the front panel.
2. Identify the node and the interface slot where the module has to be installed, see corresponding node form.
3. Take the 4-GC-LW/4-GCB-LW module with the front panel handles, aim correctly and slide it through the correct card guides (see chapter §3.4) into the allocated slot.

4. Push the module as far as possible into the node.
5. Push firmly with your thumbs on the front panel for optimal backplane contact.
6. Tighten the two fastening screws.
7. Plug the SFP module in the corresponding position (see §7.15).
8. Plug the interface cable(s) into the corresponding connector(s) (see next page(s) for pin numbers, signal names and color codes).

Engineer type	Section	Form: Operation of a 4-GC-LW/4-GCB-LW module
 <p>Duration: 10 min.</p>	<p><b>ESD</b></p>	<p>With all installation activities, adopt the ESD recommendations regarding the handling, transportation and storage of modules. Find a full ESD description in chapter 18.</p> <div style="display: flex; align-items: center;">  <p><i>Always wear an antistatic wristband in direct contact with your skin. Connect the alligator clip to the blank metal of the rack or plug the antistatic wristband into the ESD bonding point.</i></p> </div>
	<p><b>Installation Equipment</b></p>	<ul style="list-style-type: none"> <li>▶ Key of the rack (if necessary)</li> <li>▶ Screwdriver set, cable ties and cable tool set</li> <li>▶ Antistatic wristband and Fiber cleaning tool</li> <li>▶ Extra documentation can be found in chapter 15</li> </ul>
	<p><b>Operation</b></p>	<ol style="list-style-type: none"> <li>1. The 4-GC-LW/4-GCB-LW module does not require any settings, straps or adjustments prior to the installation.</li> <li>2. Connect the optical fibers, see section below.</li> <li>3. Check whether the links are up via the LEDs, info on the LEDs via manuals listed in §15.</li> <li>4. Call the control center to check whether the 4-GC-LW/4-GCB-LW module is functioning properly after having it programmed in HiProvision.</li> </ol>
	<p><b>Connect Fibers</b></p>	<ol style="list-style-type: none"> <li>1. Insert the optical modules in the corresponding TRMs (see form in §7.15). If already pre-installed, go to step 2.</li> <li>2. Label the optical fibers. Example: see picture below.</li> <li>3. Clean the front face and the ferrule of the optical fiber connector with a fiber cleaning tool.</li> <li>4. Connect the optical fibers (LC connectors) to the SFP port (1) on the 4-GC-LW/4-GCB-LW front panel.</li> <li>5. Check the W1 and LA1 LED, info on the LEDs via manuals listed in §15.</li> </ol>
	<p><b>Program 4-GC-LW/4-GCB-LW Module</b></p>	<div style="display: flex; align-items: center;">  <p>A trained HiProvision administrator must perform the HiProvision steps below in the control center. A full description of the steps below can be found in ‘Dragon PTN and HiProvision Operation’ manual, see chapter 15.</p> </div>



1. Use your cell phone to communicate with the control center and ask them to program the 4-GC-LW/4-GCB-LW in HiProvision.
2. In HiProvision, discover the network elements and links in the Dragon PTN Network.
3. In HiProvision, approve the Dragon PTN Network.
4. In HiProvision, configure all the network elements and links in the database. This could be done automatically via the discover and approve steps, or it can be done manually.
5. In HiProvision, program tunnels;
6. In HiProvision, program services;
7. Contact the control center to check if the 4-GC-LW/4-GCB-LW is functioning properly after having it discovered and programmed in HiProvision.

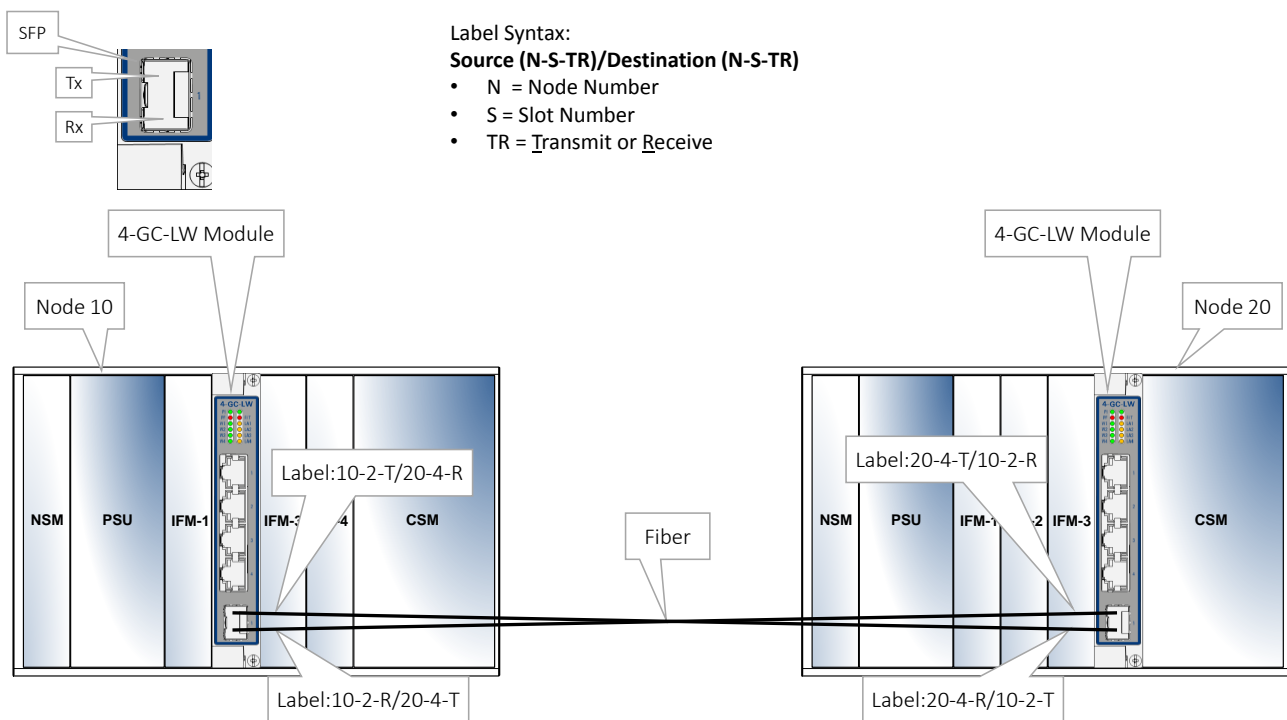

### 4-GC-LW/4-GCB-LW CABLING

Cable (10BaseT;100BaseTX): Pin Numbers and Signal Names

Signal Name	Pin Number
Rx +	1
Rx -	2
Tx +	3
not used	4
not used	5
Tx -	6
not used	7
not used	8



---

**Cable (1000Base-T): Pin Numbers and Signal Names**

<b>Signal Name</b>	<b>Pin Number</b>
DB+	1
DB-	2
DA+	3
DD+	4
DD-	5
DA-	6
DC+	7
DC-	8

---

## 7.8 7-SERIAL (942 236-014)



Engineer type	Section	Form: Installation of a 7-SERIAL module	
 <p>Duration: 1 hour</p>	<p><b>ESD</b></p>	<p>With all installation activities, adopt the ESD recommendations regarding the handling, transportation and storage of modules. Find a full ESD description in chapter 18.</p>	<p><i>Always wear an antistatic wristband in direct contact with your skin. Connect the alligator clip to the blank metal of the rack or plug the antistatic wristband into the ESD bonding point.</i></p>
<p><b>Installation Equipment</b></p>		<ul style="list-style-type: none"> <li>▶ Key of the rack (if necessary)</li> <li>▶ Screwdriver set, cable ties and cable tool set</li> <li>▶ Antistatic wristband</li> <li>▶ 7-SERIAL module</li> <li>▶ RJ.5 Interface cable(s)</li> <li>▶ Extra documentation can be found in chapter 15</li> </ul>	
<p><b>Compatibility</b></p>		<p><b>XT-1104-A/XT-2206-A/ XT-2209-A/XT-2210-A</b></p>	<p>Weight: approx. 0.24 kg / 0.5 lb</p>

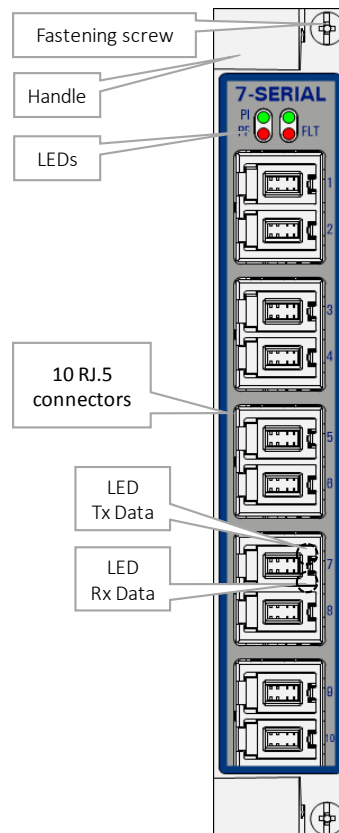

### Front Panel



- Installation**
1. Remove the ESD packaging from the interface module, do not touch or bend the EMC spring on the side of the front panel.
  2. Take the 7-SERIAL module with the front panel handles, aim correctly and slide it through the correct card guides (see chapter §3.4) into the allocated slot.
  3. Push the module as far as possible into the node.
  4. Push firmly with your thumbs on the front panel for optimal backplane contact.
  5. Tighten the two fastening screws.
  6. Plug the RJ.5 interface cable(s) into the corresponding connector(s). (See next page(s) for pin numbers, signal names and color codes).
  7. Make sure that the interface cables are well supported.
  8. Terminate the free end of the cable to the provided termination blocks of the MDF (see next page(s) for MDF details).

Engineer type	Section	Form: Operation of a 7-SERIAL module
 <p>Duration: 10 min.</p>	<p><b>ESD</b></p>	<p>With all installation activities, adopt the ESD recommendations regarding the handling, transportation and storage of modules. Find a full ESD description in chapter 18.</p> <div style="display: flex; align-items: center;">  <p><i>Always wear an antistatic wristband in direct contact with your skin. Connect the alligator clip to the blank metal of the rack or plug the antistatic wristband into the ESD bonding point.</i></p> </div>
	<p><b>Installation Equipment</b></p>	<ul style="list-style-type: none"> <li>▶ Key of the rack (if necessary)</li> <li>▶ Screwdriver set, cable ties and cable tool set</li> <li>▶ Antistatic wristband</li> <li>▶ Extra documentation can be found in chapter 15</li> </ul>
	<p><b>Operation</b></p>	<ol style="list-style-type: none"> <li>1. The 7-SERIAL module does not require any settings, straps or adjustments prior to the installation.</li> <li>2. Check whether the links are up via the LEDs, info on the LEDs via manuals listed in §15.</li> <li>3. Call the control center to check whether the 7-SERIAL module is functioning properly after having it programmed in HiProvision.</li> </ol>
	<p><b>Program 7-SERIAL Module</b></p>	<div style="display: flex; align-items: center;">  <p>A trained HiProvision administrator must perform the HiProvision steps below in the control center. A full description of the steps below can be found in ‘Dragon PTN and HiProvision Operation’ manual, see chapter 15.</p> </div> <ol style="list-style-type: none"> <li>1. Use your cell phone to communicate with the control center and ask them to program the 7-SERIAL in HiProvision.</li> </ol>

- 
2. In HiProvision, discover the network elements and links in the Dragon PTN Network.
  3. In HiProvision, approve the Dragon PTN Network.
  4. In HiProvision, configure all the network elements and links in the database. This could be done automatically via the discover and approve steps, or it can be done manually.
  5. In HiProvision, program tunnels;
  6. In HiProvision, program services;
  7. Contact the control center to check if the 7-SERIAL is functioning properly after having it discovered and programmed in HiProvision.
- 

**Serial Configuration** The 7-SERIAL module does not require any strap settings. Each serial port can be configured via HiProvision.

---

## 7-SERIAL CABLING

The 7-SERIAL module provides 10 RJ.5 connectors on the front with each connector 8 pins. As a result, a total of 80 pins are used to provide 7 serial ports that are wired out via 2 connection kits (Basic and extension kit).

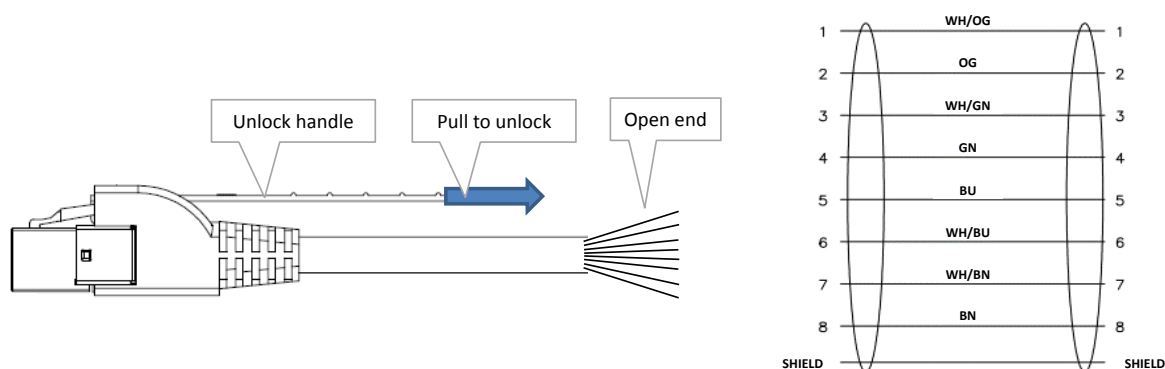

### RJ.5 Cable/Pin Numbering/Color Coding

The Basic kit (order n° 942 256-300) must be used to wire out serial port 1, 2 and 3. This kit includes 5 open end RJ.5 cables of 3 meter marked from 1 to 5. This kit must be connected to connector [1-5] on the front panel;

The Extension kit (order n° 942 256-301) must be used to wire out serial port 4, 5, 6 and 7. This kit includes 5 open end RJ.5 cables of 3 meter marked from 6 to 10. This kit must be connected to connector [6-10] on the front panel;

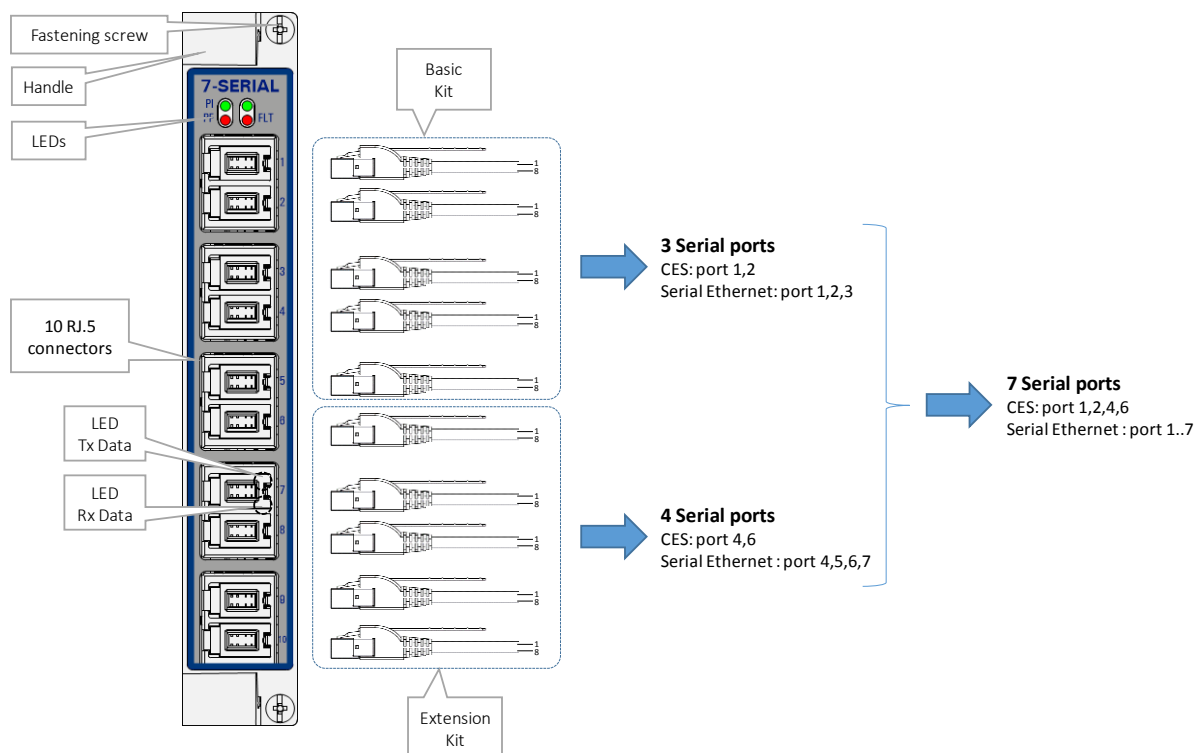

The port mapping of the Basic and extension kit can be found in the tables below.

The open end cables can be terminated to 10 pair terminal blocks. See below for more details.

Depending on how the IFM is used, the amount of available serial ports varies from 4 to 7 per IFM. The matrix figure below indicates how many and which ports (Pn) can be used to transport the indicated protocol (RS232,...) in the indicated mode (Asynchronous, Synchronous, Optimised, Full) in the indicated service (CES, Serial Ethernet). More information on all these modes and services can be found further on.

- ▶ **'CES'**: Circuit Emulation Service;
- ▶ **'X'**: this individual port can transport the indicated service;
- ▶ **'X combi'**: these two ports are required to transport the indicated service;
- ▶ **'spare'**: this individual port cannot transport the indicated service, though it can still be used to transport another service in the matrix;
- ▶ A **point-to-multipoint** service (e.g. SCADA) requires a Serial Ethernet service;

See the figure below for a Matrix overview:

	RS232			RS422			RS485		X.21		V.35	
	Async (Serial Ethernet)	Async (CES)	Sync (CES)	Async (Serial Ethernet)	Async (CES)	Sync (CES)	Async (Serial Ethernet)	Async (CES)	Optimised (CES)	Full (CES)	Optimised (CES)	Full (CES)
<b>P1</b>	X	X	X	X	X	spare	X	X	X	spare	X	spare
<b>P2</b>	X	X	X	X	X	X combi	X	X	X	X combi	X	X combi
<b>P3</b>	X	spare	spare	X	spare		X	spare	spare		spare	
<b>P4</b>	X	X	X	X	X	X combi	X	X	X	X combi	X	X combi
<b>P5</b>	X	spare	spare	X	spare		X	spare	spare		spare	
<b>P6</b>	X	X	X	X	X	X combi	X	X	X	X combi	X	X combi
<b>P7</b>	X	spare	spare	X	spare		X	spare	spare		spare	

Depending on the serial protocol standards and serial Port Role (DTE or DCE), the serial port has the signals as shown in the tables below. Each serial port [1,...,7] has 11 pins;

See table below for more details.

**RJ.5 Cables to Serial Ports Mapping (Basic Kit)**

Cable Kit	RJ.5 Cable	RJ.5 Pin n°	Color	Serial Port – Pin n°
Basic Kit	1	1	WH/OG	1-1
		2	OG	1-2
		3	WH/GN	1-3
		4	GN	1-4
		5	BU	1-5
		6	WH/BU	1-6
		7	WH/BN	1-7
		8	BN	1-8
	2	1	WH/OG	1-9
		2	OG	1-10
		3	WH/GN	GND
		4	GN	GND
		5	BU	GND
		6	WH/BU	GND
		7	WH/BN	GND
		8	BN	GND
	3	1	WH/OG	2-1
		2	OG	2-2
		3	WH/GN	2-3
		4	GN	2-4
		5	BU	2-5
		6	WH/BU	2-6
		7	WH/BN	2-7
		8	BN	2-8
	4	1	WH/OG	2-9
		2	OG	2-10
		3	WH/GN	3-1
		4	GN	3-2
		5	BU	3-3
		6	WH/BU	3-4
		7	WH/BN	3-5
		8	BN	3-6
	5	1	WH/OG	GND
		2	OG	Frame GND
		3	WH/GN	Frame GND
		4	GN	Frame GND
		5	BU	3-7
		6	WH/BU	3-8
		7	WH/BN	3-9
		8	BN	3-10



### RJ.5 Cables to Serial Ports Mapping (Extension Kit)

Cable Kit	RJ.5 Cable	RJ.5 Pin n°	Color	Serial Port – Pin n°
Extension Kit	6	1	WH/OG	4-1
		2	OG	4-2
		3	WH/GN	4-3
		4	GN	4-4
		5	BU	4-5
		6	WH/BU	4-6
		7	WH/BN	4-7
		8	BN	4-8
	7	1	WH/OG	4-9
		2	OG	4-10
		3	WH/GN	5-1
		4	GN	5-2
		5	BU	5-3
		6	WH/BU	5-4
		7	WH/BN	5-5
		8	BN	5-6
	8	1	WH/OG	6-1
		2	OG	6-2
		3	WH/GN	6-3
		4	GN	6-4
		5	BU	6-5
		6	WH/BU	6-6
		7	WH/BN	6-7
		8	BN	6-8
	9	1	WH/OG	6-9
		2	OG	6-10
		3	WH/GN	7-1
		4	GN	7-2
		5	BU	7-3
		6	WH/BU	7-4
		7	WH/BN	7-5
		8	BN	7-6
10	1	WH/OG	5-7	
	2	OG	5-8	
	3	WH/GN	5-9	
	4	GN	5-10	
	5	BU	7-7	
	6	WH/BU	7-8	
	7	WH/BN	7-9	
	8	BN	7-10	

An individual serial port ('X', see matrix overview before) has 11 pins whereas a combined serial port ('X combi', see matrix overview before) has 22 pins. See table below.

In RS232, RS422, X.21, V.35: Pin 9, 10, 20 and 21 are bidirectional pins. If the signal is available, the pin is output in DTE and input in DCE.

Previous tables shows where all these pins are outputted via the basic and extension kit.

### Signals per Serial Port

Serial Port n°	Pin n°	In/Out	RS232				RS422				RS485	X.21				V.35			
			Asynchronous		Synchronous		Asynchronous		Synchronous			Optimised	Full		Optimised		Full		
			DTE	DCE	DTE	DCE	DTE	DCE	DTE	DCE			DTE	DCE	DTE	DCE	DTE	DCE	
n	1	Out1+	TxD	RxD	TxD	RxD	TxD <sub>b</sub>	RxD <sub>b</sub>	TxD <sub>b</sub>	RxD <sub>b</sub>	Tri-state	TxD <sub>b</sub>	RxD <sub>b</sub>	TxD <sub>b</sub>	RxD <sub>b</sub>	TxD <sub>b</sub>	RxD <sub>b</sub>	TxD <sub>b</sub>	RxD <sub>b</sub>
	2	Out1-	RTS	CTS	RTS	CTS	TxD <sub>a</sub>	RxD <sub>a</sub>	TxD <sub>a</sub>	RxD <sub>a</sub>	Tri-state	TxD <sub>a</sub>	RxD <sub>a</sub>	TxD <sub>a</sub>	RxD <sub>a</sub>	TxD <sub>a</sub>	RxD <sub>a</sub>	TxD <sub>a</sub>	RxD <sub>a</sub>
	3	In1+	RxD	TxD	RxD	TxD	RxD <sub>b</sub>	TxD <sub>b</sub>	RxD <sub>b</sub>	TxD <sub>b</sub>	---	RxD <sub>b</sub>	TxD <sub>b</sub>	RxD <sub>b</sub>	TxD <sub>b</sub>	RxD <sub>b</sub>	TxD <sub>b</sub>	RxD <sub>b</sub>	TxD <sub>b</sub>
	4	In1-	CTS	RTS	CTS	RTS	RxD <sub>a</sub>	TxD <sub>a</sub>	RxD <sub>a</sub>	TxD <sub>a</sub>	---	RxD <sub>a</sub>	TxD <sub>a</sub>	RxD <sub>a</sub>	TxD <sub>a</sub>	RxD <sub>a</sub>	TxD <sub>a</sub>	RxD <sub>a</sub>	TxD <sub>a</sub>
	5	Out2+	---	---	TTC	RxC	RTS <sub>b</sub>	CTS <sub>b</sub>	TTC <sub>b</sub>	RxC <sub>b</sub>	Tri-state	C <sub>b</sub>	I <sub>b</sub>	C <sub>b</sub>	I <sub>b</sub>	TTC <sub>b</sub>	RxC <sub>b</sub>	TTC <sub>b</sub>	RxC <sub>b</sub>
	6	Out2-	DTR	DSR	DTR	DSR	RTS <sub>a</sub>	CTS <sub>a</sub>	TTC <sub>a</sub>	RxC <sub>a</sub>	Tri-state	C <sub>a</sub>	I <sub>a</sub>	C <sub>a</sub>	I <sub>a</sub>	TTC <sub>a</sub>	RxC <sub>a</sub>	TTC <sub>a</sub>	RxC <sub>a</sub>
	7	In2+	---	---	RxC	TTC	CTS <sub>b</sub>	RTS <sub>b</sub>	RxC <sub>b</sub>	TTC <sub>b</sub>	---	I <sub>b</sub>	C <sub>b</sub>	I <sub>b</sub>	C <sub>b</sub>	RxC <sub>b</sub>	TTC <sub>b</sub>	RxC <sub>b</sub>	TTC <sub>b</sub>
	8	In2-	DSR	DTR	DSR	DTR	CTS <sub>a</sub>	RTS <sub>a</sub>	RxC <sub>a</sub>	TTC <sub>a</sub>	---	I <sub>a</sub>	C <sub>a</sub>	I <sub>a</sub>	C <sub>a</sub>	RxC <sub>a</sub>	TTC <sub>a</sub>	RxC <sub>a</sub>	TTC <sub>a</sub>
	9	In3/Out3+	---	---	TxC(In)	TxC(Out)	DCD <sub>b</sub> (In)	DCD <sub>b</sub> (Out)	TxC <sub>b</sub> (In)	TxC <sub>b</sub> (Out)	TRxD <sub>b</sub>	S <sub>b</sub> (In)	S <sub>b</sub> (Out)	S <sub>b</sub> (In)	S <sub>b</sub> (Out)	TxC <sub>b</sub> (In)	TxC <sub>b</sub> (Out)	TxC <sub>b</sub> (In)	TxC <sub>b</sub> (Out)
	10	In3/Out3-	DCD(In)	DCD(Out)	DCD(In)	DCD(Out)	DCD <sub>a</sub> (In)	DCD <sub>a</sub> (Out)	TxC <sub>a</sub> (In)	TxC <sub>a</sub> (Out)	TRxD <sub>a</sub>	S <sub>a</sub> (In)	S <sub>a</sub> (Out)	S <sub>a</sub> (In)	S <sub>a</sub> (Out)	TxC <sub>a</sub> (In)	TxC <sub>a</sub> (Out)	TxC <sub>a</sub> (In)	TxC <sub>a</sub> (Out)
	11	GND	GND	GND	GND	GND	GND	GND	GND	GND	GND	GND	GND	GND	GND	GND	GND	GND	GND
n+1 (=combi)	1	Out1+						RTS <sub>b</sub>	CTS <sub>b</sub>				X <sub>b</sub>	B <sub>b</sub>			---	---	
	2	Out1-						RTS <sub>a</sub>	CTS <sub>a</sub>				X <sub>a</sub>	B <sub>a</sub>			RTS	CTS	
	3	In1+						CTS <sub>b</sub>	RTS <sub>b</sub>				B <sub>b</sub>	X <sub>b</sub>			---	---	
	4	In1-						CTS <sub>a</sub>	RTS <sub>a</sub>				B <sub>a</sub>	X <sub>a</sub>			CTS	RTS	
	5	Out2+						DTR <sub>b</sub>	DSR <sub>b</sub>				---	---			---	---	
	6	Out2-						DTR <sub>a</sub>	DSR <sub>a</sub>				---	---			DTR	DSR	
	7	In2+						DSR <sub>b</sub>	DTR <sub>b</sub>				---	---			---	---	
	8	In2-						DSR <sub>a</sub>	DTR <sub>a</sub>				---	---			DSR	DTR	
	9	In3/Out3+						DCD <sub>b</sub> (In)	DCD <sub>b</sub> (Out)				---	---			---	---	
	10	In3/Out3-						DCD <sub>a</sub> (In)	DCD <sub>a</sub> (Out)				---	---			DCD(In)	DCD(Out)	
	11	GND						GND	GND				GND	GND			GND	GND	











## V.35 Full Mode DTE



Basic Kit	RJ.5 Front panel n°/Cable	RJ.5 pin n°	RJ.5 Connector 1 Cable								RJ.5 Connector 2 Cable								RJ.5 Connector 5 Cable								Termination block
	Block Pair		1	2	3	4	5	6	7	8	1	2	3	4	5	6	7	8	1	2	3	4					
	Color		WH/OG	OG	WH/GN	GN	BU	WH/BU	WH/BN	BN	WH/OG	OG	WH/GN	GN	BU	WH/BU	WH/BN	BN	WH/OG	OG	WH/GN	GN					
	Signal																										
	Port n°		Serial Port 1																GND								
	Ext.Eq.																										
Basic Kit	RJ.5 Front panel n°/Cable	RJ.5 pin n°	RJ.5 Connector 3 Cable								RJ.5 Connector 4 Cable								RJ.5 Connector 5 Cable								Termination block
	Block Pair		1	2	3	4	5	6	7	8	1	2	3	4	5	6	7	8	5	6	7	8					
	Color		WH/OG	OG	WH/GN	GN	BU	WH/BU	WH/BN	BN	WH/OG	OG	WH/GN	GN	BU	WH/BU	WH/BN	BN	BU	WH/BU	WH/BN	BN					
	Signal		TxDb	TxDa	RxDb	RxDa	TTCb	TTCa	RxCb	RxCa	TXCb(m)	TXCa(m)	---	RTS	---	CTS	---	DTR	---	DSR	---	DCD(m)					
	Port n°		Serial Port 2																Serial Port 3								
	Ext.Eq.																										
Extension Kit	RJ.5 Front panel n°/Cable	RJ.5 pin n°	RJ.5 Connector 6 Cable								RJ.5 Connector 7 Cable								RJ.5 Connector 10 Cable								Termination block
	Block Pair		1	2	3	4	5	6	7	8	1	2	3	4	5	6	7	8	1	2	3	4					
	Color		WH/OG	OG	WH/GN	GN	BU	WH/BU	WH/BN	BN	WH/OG	OG	WH/GN	GN	BU	WH/BU	WH/BN	BN	WH/OG	OG	WH/GN	GN					
	Signal		TxDb	TxDa	RxDb	RxDa	TTCb	TTCa	RxCb	RxCa	TXCb(m)	TXCa(m)	---	RTS	---	CTS	---	DTR	---	DSR	---	DCD(m)					
	Port n°		Serial Port 4																Serial Port 5								
	Ext.Eq.																										
Extension Kit	RJ.5 Front panel n°/Cable	RJ.5 pin n°	RJ.5 Connector 8 Cable								RJ.5 Connector 9 Cable								RJ.5 Connector 10 Cable								Termination block
	Block Pair		1	2	3	4	5	6	7	8	1	2	3	4	5	6	7	8	5	6	7	8					
	Color		WH/OG	OG	WH/GN	GN	BU	WH/BU	WH/BN	BN	WH/OG	OG	WH/GN	GN	BU	WH/BU	WH/BN	BN	BU	WH/BU	WH/BN	BN					
	Signal		TxDb	TxDa	RxDb	RxDa	TTCb	TTCa	RxCb	RxCa	TXCb(m)	TXCa(m)	---	RTS	---	CTS	---	DTR	---	DSR	---	DCD(m)					
	Port n°		Serial Port 6																Serial Port 7								
	Ext.Eq.																										

## V.35 Full Mode DCE

Basic Kit	RJ.5 Front panel n°/Cable	RJ.5 pin n°	RJ.5 Connector 1 Cable								RJ.5 Connector 2 Cable								RJ.5 Connector 5 Cable								Termination block
	Block Pair		1	2	3	4	5	6	7	8	1	2	3	4	5	6	7	8	1	2	3	4					
	Color		WH/OG	OG	WH/GN	GN	BU	WH/BU	WH/BN	BN	WH/OG	OG	WH/GN	GN	BU	WH/BU	WH/BN	BN	WH/OG	OG	WH/GN	GN					
	Signal																										
	Port n°		Serial Port 1																GND								
	Ext.Eq.																										
Basic Kit	RJ.5 Front panel n°/Cable	RJ.5 pin n°	RJ.5 Connector 3 Cable								RJ.5 Connector 4 Cable								RJ.5 Connector 5 Cable								Termination block
	Block Pair		1	2	3	4	5	6	7	8	1	2	3	4	5	6	7	8	5	6	7	8					
	Color		WH/OG	OG	WH/GN	GN	BU	WH/BU	WH/BN	BN	WH/OG	OG	WH/GN	GN	BU	WH/BU	WH/BN	BN	BU	WH/BU	WH/BN	BN					
	Signal		RxDb	RxDa	TxDb	TxDa	RxCb	RxCa	TTCb	TTCa	TXCb(out)	TXCa(out)	---	CTS	---	RTS	---	DSR	---	DTR	---	DCD(out)					
	Port n°		Serial Port 2																Serial Port 3								
	Ext.Eq.																										
Extension Kit	RJ.5 Front panel n°/Cable	RJ.5 pin n°	RJ.5 Connector 6 Cable								RJ.5 Connector 7 Cable								RJ.5 Connector 10 Cable								Termination block
	Block Pair		1	2	3	4	5	6	7	8	1	2	3	4	5	6	7	8	1	2	3	4					
	Color		WH/OG	OG	WH/GN	GN	BU	WH/BU	WH/BN	BN	WH/OG	OG	WH/GN	GN	BU	WH/BU	WH/BN	BN	WH/OG	OG	WH/GN	GN					
	Signal		RxDb	RxDa	TxDb	TxDa	RxCb	RxCa	TTCb	TTCa	TXCb(out)	TXCa(out)	---	CTS	---	RTS	---	DSR	---	DTR	---	DCD(out)					
	Port n°		Serial Port 4																Serial Port 5								
	Ext.Eq.																										
Extension Kit	RJ.5 Front panel n°/Cable	RJ.5 pin n°	RJ.5 Connector 8 Cable								RJ.5 Connector 9 Cable								RJ.5 Connector 10 Cable								Termination block
	Block Pair		1	2	3	4	5	6	7	8	1	2	3	4	5	6	7	8	5	6	7	8					
	Color		WH/OG	OG	WH/GN	GN	BU	WH/BU	WH/BN	BN	WH/OG	OG	WH/GN	GN	BU	WH/BU	WH/BN	BN	BU	WH/BU	WH/BN	BN					
	Signal		RxDb	RxDa	TxDb	TxDa	RxCb	RxCa	TTCb	TTCa	TXCb(out)	TXCa(out)	---	CTS	---	RTS	---	DSR	---	DTR	---	DCD(out)					
	Port n°		Serial Port 6																Serial Port 7								
	Ext.Eq.																										



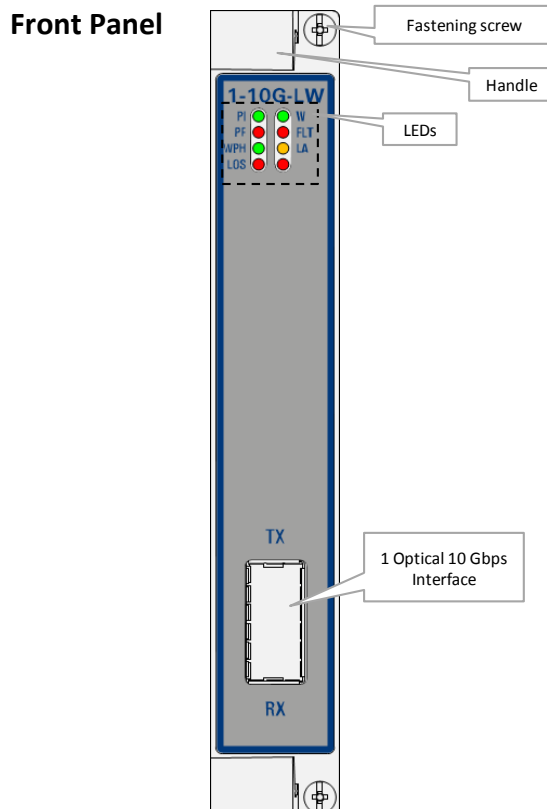

## 7.9 1-10G-LW (942 236-004)

Engineer type	Section	Form: Installation of a 1-10G-LW module
 <p>Duration: 1 hour</p>	<p><b>ESD</b></p> <p>With all installation activities, adopt the ESD recommendations regarding the handling, transportation and storage of modules. Find a full ESD description in chapter 18.</p> <p><b>Always wear an antistatic wristband in direct contact with your skin. Connect the alligator clip to the blank metal of the rack or plug the antistatic wristband into the ESD bonding point.</b></p> 	
<p><b>Installation Equipment</b></p> <ul style="list-style-type: none"> <li>▶ Key of the rack (if necessary)</li> <li>▶ Screwdriver set, cable ties, cable tool set and Fiber cleaning tool</li> <li>▶ Antistatic wristband</li> <li>▶ 1-10G-LW module + XFP module</li> <li>▶ Interface cable(s) and fiber optic patch cords</li> <li>▶ Extra documentation can be found in chapter 15</li> </ul>		
<p><b>Compatibility</b></p>  <p><b>XT-2206-A/XT-2209-A XT-2210-A</b></p> <p>Weight: approx. 0.25 kg / 0.6 lb</p>		



- Installation**
1. Remove the ESD packaging from the interface module, do not touch or bend the EMC spring on the side of the front panel.
  2. Identify the node and the interface slot where the module has to be installed, see corresponding node form.

3. Take the 1-10G-LW module with the front panel handles, aim correctly and slide it through the correct card guides (see chapter §3.4) into the allocated slot.
4. Push the module as far as possible into the node.
5. Push firmly with your thumbs on the front panel for optimal backplane contact.
6. Tighten the two fastening screws.
7. Plug the XFP module in the corresponding position (see §7.15).
8. Plug the interface cable into the corresponding connector (see next page(s) for pin numbers, signal names and color codes).

Engineer type	Section	Form: Operation of a 1-10G-LW module
 <p>Duration: 10 min.</p>	<p><b>ESD</b></p>	<p>With all installation activities, adopt the ESD recommendations regarding the handling, transportation and storage of modules. Find a full ESD description in chapter 18.</p> <div style="display: flex; align-items: center; justify-content: center;">  <p><i>Always wear an antistatic wristband in direct contact with your skin. Connect the alligator clip to the blank metal of the rack or plug the antistatic wristband into the ESD bonding point.</i></p> </div>
	<p><b>Installation Equipment</b></p>	<ul style="list-style-type: none"> <li>▶ Key of the rack (if necessary)</li> <li>▶ Screwdriver set, cable ties and cable tool set</li> <li>▶ Antistatic wristband and Fiber cleaning tool</li> <li>▶ Extra documentation can be found in chapter 15</li> </ul>
	<p><b>Operation</b></p>	<ol style="list-style-type: none"> <li>1. The 1-10G-LW module does not require any settings, straps or adjustments prior to the installation.</li> <li>2. Connect the optical fibers, see section below.</li> <li>3. Check whether the links are up via the LEDs, info on the LEDs via manuals listed in §15.</li> <li>4. Call the control center to check whether the 1-10G-LW module is functioning properly after having it programmed in HiProvision.</li> </ol>
	<p><b>Connect Fibers</b></p>	<ol style="list-style-type: none"> <li>1. Insert the optical modules in the corresponding TRMs (see form in §7.15). If already pre-installed, go to step 2.</li> <li>2. Label the optical fibers. Example: see picture below.</li> <li>3. Clean the front face and the ferrule of the optical fiber connector with a fiber cleaning tool.</li> <li>4. Connect the optical fibers (LC connectors) to the XFP port (1) on the 1-10G-LW front panel.</li> <li>5. Check the WPH and LA LED, info on the LEDs via manuals listed in §15.</li> </ol>

## Program 1-10G-LW Module



A trained HiProvision administrator must perform the HiProvision steps below in the control center. A full description of the steps below can be found in 'Dragon PTN Operation' manual, see chapter 15.

1. Use your cell phone to communicate with the control center and ask them to program the 1-10G-LW in HiProvision.
2. In HiProvision, discover the network elements and links in the Dragon PTN Network.
3. In HiProvision, approve the Dragon PTN Network.
4. In HiProvision, configure all the network elements and links in the database. This could be done automatically via the discover and approve steps, or it can be done manually.
5. In HiProvision, program tunnels;
6. In HiProvision, program services;
7. Contact the control center to check if the 1-10G-LW is functioning properly after having it discovered and programmed in HiProvision.

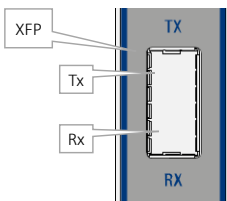

Label Syntax:

**Source (N-S-TR)/Destination (N-S-TR)**

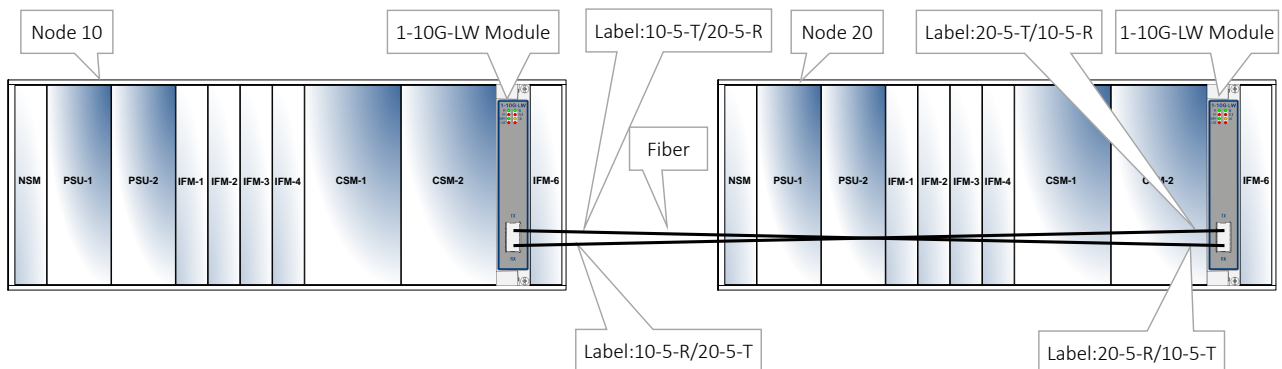

- N = Node Number
- S = Slot Number
- TR = Transmit or Receive



### 1-10G-LW CABLING

The 1-10G-LW module has only an optical connector on the front side and therefore thus not requires any other cables.

## 7.10 4-2/4WEM (future support)

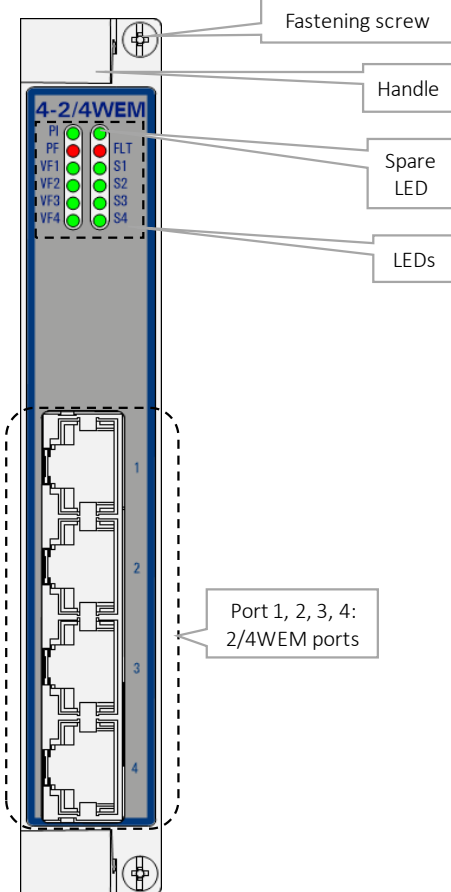
Engineer type	Section	Form: Installation of a 4-2/4WEM module
 <p>Duration: 1 hour</p>	<p><b>ESD</b></p>	<p>With all installation activities, the ESD recommendations regarding the handling, transportation and storage of modules must be adopted. A full ESD description can be found in chapter 18.</p> <div style="display: flex; align-items: center;">  <p><i>Always wear an antistatic wristband in direct contact with your skin. Connect the alligator clip to the blank metal of the rack or plug the antistatic wristband into the ESD bonding point.</i></p> </div>
<p><b>Installation Equipment</b></p>		<ul style="list-style-type: none"> <li>▶ Key of the rack (if necessary)</li> <li>▶ Screwdriver set, cable ties and cable tool set</li> <li>▶ Antistatic wristband</li> <li>▶ 4-2/4WEM module</li> <li>▶ Interface cable(s)</li> <li>▶ Extra documentation can be found in chapter 15</li> </ul>
<p><b>Compatibility</b></p>	<p></p>	<p><b>XT-1104-A/XT-2206-A/ XT-2209-A/XT-2210-A</b>      Weight: approx. 0.24 kg / 0.5 lb</p>
<p><b>Front Panel</b></p>		

- Installation**
1. Remove the ESD packaging from the interface module, do not touch or bend the EMC spring on the side of the front panel.
  2. Identify the node and the interface slot where the module has to be installed, see corresponding node form.
  3. Take the 4-2/4WEM module with the front panel handles, aim correctly and slide it through the correct card guides (see chapter §3.4) into the allocated slot.
  4. Push the module as far as possible into the node.
  5. Push firmly with your thumbs on the front panel for optimal backplane contact.
  6. Tighten the two fastening screws.
  7. Plug the interface cable(s) into the corresponding connector(s) (see next page(s) for pin numbers, signal names and color codes).

Engineer type	Section	Form: Operation of a 4-2/4WEM module
---------------	---------	--------------------------------------



**ESD**

With all installation activities, the ESD recommendations regarding the handling, transportation and storage of modules must be adopted. A full ESD description can be found in chapter 18.

Duration:  
10 min.



*Always wear an antistatic wristband in direct contact with your skin. Connect the alligator clip to the blank metal of the rack or plug the antistatic wristband into the ESD bonding point.*

- Installation Equipment**
- ▶ Key of the rack (if necessary)
  - ▶ Screwdriver set, cable ties and cable tool set
  - ▶ Antistatic wristband
  - ▶ Extra documentation can be found in chapter 15

- Operation**
1. The 4-2/4XEM module does not require any settings, straps or adjustments prior to the installation.
  2. Check whether the links are up via the LEDs, info on the LEDs via manuals listed in §15.
  3. Call the control center to check whether the 4-2/4WEM module is functioning properly after having it programmed in HiProvision.

**Program 4-2/4WEM Module**



A trained HiProvision administrator must perform the HiProvision steps below in the control center. A full description of the steps below can be found in 'Dragon PTN and HiProvision Operation' manual, see chapter 15.

1. Use your cell phone to communicate with the control center and ask them to program the 4-2/4WEM in HiProvision.
2. In HiProvision, discover the network elements and links in the

---

Dragon PTN Network.

3. In HiProvision, approve the Dragon PTN Network.
  4. In HiProvision, configure all the network elements and links in the database. This could be done automatically via the discover and approve steps, or it can be done manually.
  5. In HiProvision, program tunnels;
  6. In HiProvision, program services;
  7. Contact the control center to check if the 4-2/4WEM is functioning properly after having it discovered and programmed in HiProvision.
- 

### 4-2/4WEM CABLING

The 4-2/4WEM module provides four RJ-45 ports and each port connector has eight pins. Each port provides one tip/ring pair. See the table and figure below for an overview and description. A CAT5E shielded cable with one side open end must be used to connect the RJ-45 ports

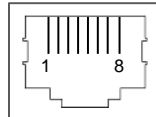

#### Color Codes, Pin Numbers, Signal Names

Pin Number	Description	Input/Output
1 (=future)	E (Ear)	Input
2 (=future)	M (Mouth)	Output
3	TxA (Transmit A)	Output
4	RxA (Receive A)	Input
5	RxB (Receive B)	Input
6	TxB (Transmit B)	Output
7 (=future)	SG (Signal Ground)	---
8 (=future)	SB (Signal Battery)	---

---

## 7.11 4-CODIR (future support)

Engineer type	Section	Form: Installation of a 4-CODIR module
---------------	---------	--



### ESD

With all installation activities, the ESD recommendations regarding the handling, transportation and storage of modules must be adopted. A full ESD description can be found in chapter 18.

Duration:  
1 hour



*Always wear an antistatic wristband in direct contact with your skin. Connect the alligator clip to the blank metal of the rack or plug the antistatic wristband into the ESD bonding point.*

- |                               |  |
|-------------------------------|--|
| <b>Installation Equipment</b> | <ul style="list-style-type: none"> <li>▶ Key of the rack (if necessary)</li> <li>▶ Screwdriver set, cable ties and cable tool set</li> <li>▶ Antistatic wristband</li> <li>▶ 4-CODIR module</li> <li>▶ Interface cable(s)</li> <li>▶ Extra documentation can be found in chapter 15</li> </ul> |
|-------------------------------|--|

### Compatibility



**XT-1104-A/XT-2206-A/  
XT-2209-A/XT-2210-A**

Weight: approx. 0.27 kg  
/ 0.6 lb

### Front Panel

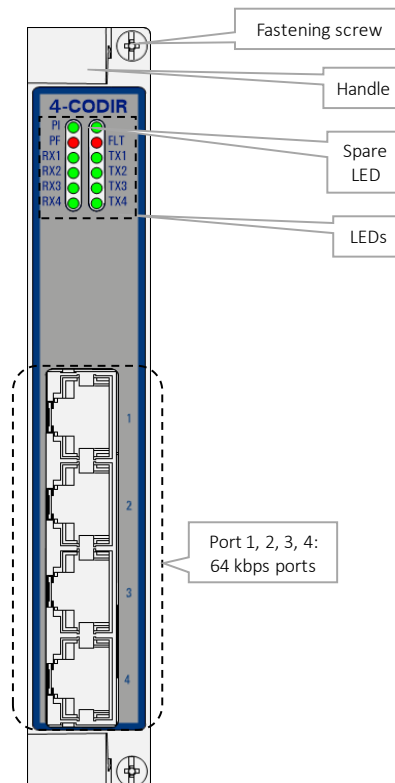

- |                     |  |
|---------------------|--|
| <b>Installation</b> | <ol style="list-style-type: none"> <li>1. Remove the ESD packaging from the interface module, do not touch or bend the EMC spring on the side of the front panel.</li> <li>2. Identify the node and the interface slot where the module has to be installed, see corresponding node form.</li> </ol> |
|---------------------|--|

3. Take the 4-CODIR module with the front panel handles, aim correctly and slide it through the correct card guides (see chapter §3.4) into the allocated slot.
4. Push the module as far as possible into the node.
5. Push firmly with your thumbs on the front panel for optimal backplane contact.
6. Tighten the two fastening screws.
7. Plug the interface cable(s) into the corresponding connector(s) (see next page(s) for pin numbers, signal names and color codes).

Engineer type	Section	Form: Operation of a 4-CODIR module
---------------	---------	-------------------------------------



Duration:  
10 min.

### ESD

With all installation activities, the ESD recommendations regarding the handling, transportation and storage of modules must be adopted. A full ESD description can be found in chapter 18.



*Always wear an antistatic wristband in direct contact with your skin. Connect the alligator clip to the blank metal of the rack or plug the antistatic wristband into the ESD bonding point.*

### Installation Equipment

- ▶ Key of the rack (if necessary)
- ▶ Screwdriver set, cable ties and cable tool set
- ▶ Antistatic wristband
- ▶ Extra documentation can be found in chapter 15

### Operation

1. The 4-CODIR module does not require any settings, straps or adjustments prior to the installation.
2. Check whether the links are up via the LEDs, info on the LEDs via manuals listed in §15.
3. Call the control center to check whether the 4-CODIR module is functioning properly after having it programmed in HiProvision.

### Program 4-CODIR Module



A trained HiProvision administrator must perform the HiProvision steps below in the control center. A full description of the steps below can be found in 'Dragon PTN and HiProvision Operation' manual, see chapter 15.

1. Use your cell phone to communicate with the control center and ask them to program the 4-CODIR in HiProvision.
2. In HiProvision, discover the network elements and links in the Dragon PTN Network.
3. In HiProvision, approve the Dragon PTN Network.
4. In HiProvision, configure all the network elements and links in the database. This could be done automatically via the discover and approve steps, or it can be done manually.



- 
5. In HiProvision, program tunnels;
  6. In HiProvision, program services;
  7. Contact the control center to check if the 4-CODIR is functioning properly after having it discovered and programmed in HiProvision.
- 

### 4-CODIR CABLING

E1 cable (120  $\Omega$ ): ordering number 942 256-201

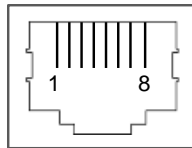

#### RJ-45 Connector: Pin Assignments

Pin Number	Description	Cable Wire Colors
1	Rx (Receive) RING	OG
2	Rx (Receive) TIP	WH/OG
3	Not connected	-
4	Tx (Transmit) RING	BU
5	Tx (Transmit) TIP	WH/BU
6, 7, 8	Not connected	-

## 7.12 4-GO-LW (942 236-002)

Engineer type	Section	Form: Installation of a 4-GO-LW module
---------------	---------	--



### ESD

With all installation activities, adopt the ESD recommendations regarding the handling, transportation and storage of modules. Find a full ESD description in chapter 18.

Duration:  
1 hour



*Always wear an antistatic wristband in direct contact with your skin. Connect the alligator clip to the blank metal of the rack or plug the antistatic wristband into the ESD bonding point.*

### Installation Equipment

- ▶ Key of the rack (if necessary)
- ▶ Screwdriver set, cable ties, cable tool set and Fiber cleaning tool
- ▶ Antistatic wristband
- ▶ 4-GO-LW module + SFP module(s)
- ▶ Interface cable(s) and fiber optic patch cords
- ▶ Extra documentation can be found in chapter 15

### Compatibility



**XT-1104-A/XT-2206-A/  
XT-2209-A/XT-2210-A**

Weight: approx. 0.26 kg /  
0.6 lb

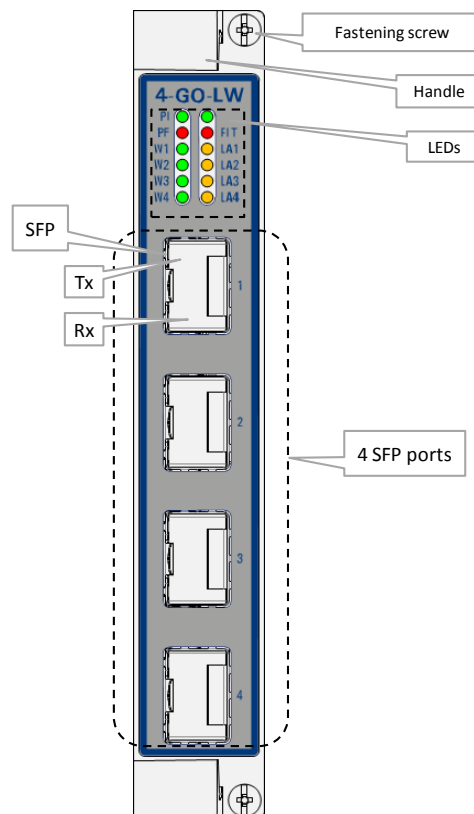

### Front Panel



### Installation

1. Remove the ESD packaging from the interface module, do not touch or bend the EMC spring on the side of the front panel.
2. Identify the node and the interface slot where the module has to be installed, see corresponding node form.

3. Take the 4-GO-LW module with the front panel handles, aim correctly and slide it through the correct card guides (see chapter §3.4) into the allocated slot.
4. Push the module as far as possible into the node.
5. Push firmly with your thumbs on the front panel for optimal backplane contact.
6. Tighten the two fastening screws.
7. Plug the SFP module in the corresponding position (see §7.15).
8. Plug the interface cable(s) into the corresponding connector(s) (see next page(s) for pin numbers, signal names and color codes).

Engineer type	Section	Form: Operation of a 4-GO-LW module
 <p>Duration: 10 min.</p>	<p><b>ESD</b></p>	<p>With all installation activities, adopt the ESD recommendations regarding the handling, transportation and storage of modules. Find a full ESD description in chapter 18.</p> <div style="display: flex; align-items: center; justify-content: center;">  <p><i>Always wear an antistatic wristband in direct contact with your skin. Connect the alligator clip to the blank metal of the rack or plug the antistatic wristband into the ESD bonding point.</i></p> </div>
	<p><b>Installation Equipment</b></p>	<ul style="list-style-type: none"> <li>▶ Key of the rack (if necessary)</li> <li>▶ Screwdriver set, cable ties and cable tool set</li> <li>▶ Antistatic wristband and Fiber cleaning tool</li> <li>▶ Extra documentation can be found in chapter 15</li> </ul>
	<p><b>Operation</b></p>	<ol style="list-style-type: none"> <li>1. The 4-GO-LW module does not require any settings, straps or adjustments prior to the installation.</li> <li>2. Connect the optical fibers, see section below.</li> <li>3. Check whether the links are up via the LEDs, info on the LEDs via manuals listed in §15.</li> <li>4. Call the control center to check whether the 4-GO-LW module is functioning properly after having it programmed in HiProvision.</li> </ol>
	<p><b>Connect Fibers</b></p>	<ol style="list-style-type: none"> <li>1. Insert the optical modules in the corresponding TRMs (see form in §7.15). If already pre-installed, go to step 2.</li> <li>2. Label the optical fibers. Example: see picture below.</li> <li>3. Clean the front face and the ferrule of the optical fiber connector with a fiber cleaning tool.</li> <li>4. Connect the optical fibers (LC connectors) to an SFP port on the 4-GO-LW front panel.</li> <li>5. Check the W (1-4) and LA (1-4) LED, info on the LEDs via manuals listed in §15.</li> </ol>

## Program 4-GO-LW Module



A trained HiProvision administrator must perform the HiProvision steps below in the control center. A full description of the steps below can be found in 'Dragon PTN and HiProvision Operation' manual, see chapter 15.

1. Use your cell phone to communicate with the control center and ask them to program the 4-GO-LW in HiProvision.
2. In HiProvision, discover the network elements and links in the Dragon PTN Network.
3. In HiProvision, approve the Dragon PTN Network.
4. In HiProvision, configure all the network elements and links in the database. This could be done automatically via the discover and approve steps, or it can be done manually.
5. In HiProvision, program tunnels;
6. In HiProvision, program services;
7. Contact the control center to check if the 4-GO-LW is functioning properly after having it discovered and programmed in HiProvision.

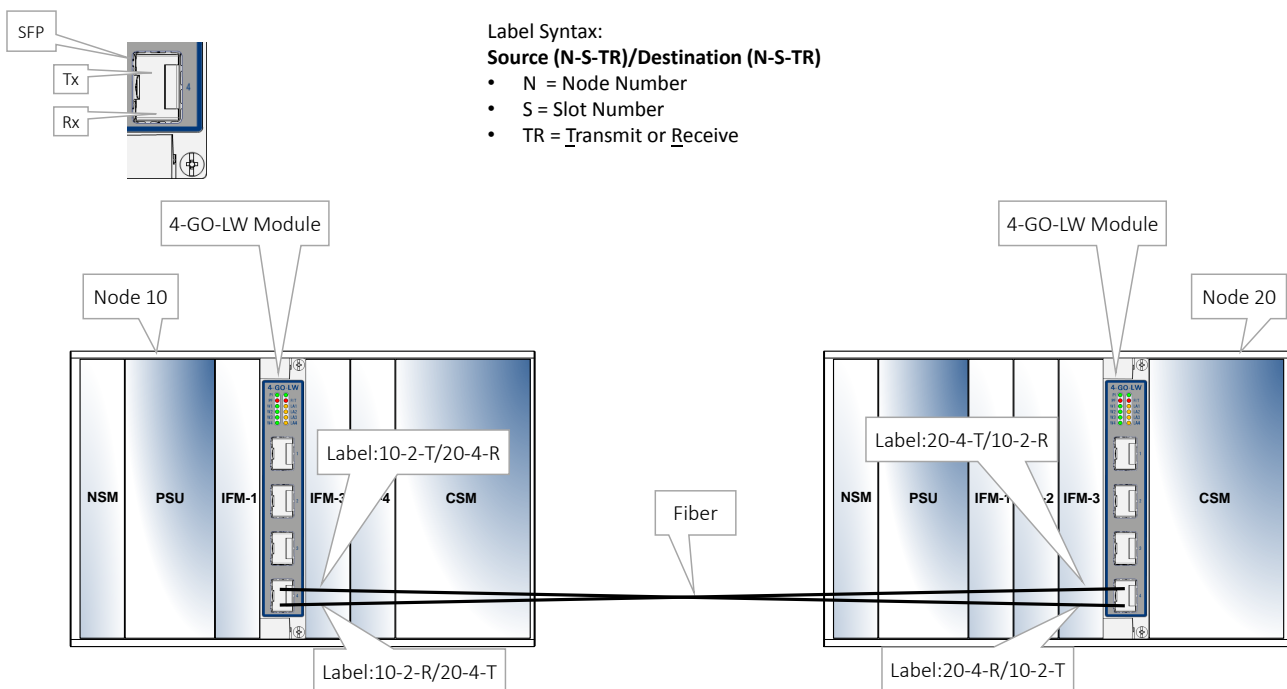

### 4-GO-LW CABLING

The 4-GO-LW module has only optical connectors on the front side and therefore thus not requires any other cables.

### 7.13 2-OLS (with E1: future support / with T1: future support)

Engineer type	Section	Form: Installation of a 2-OLS module
---------------	---------	--------------------------------------



#### ESD

With all installation activities, adopt the ESD recommendations regarding the handling, transportation and storage of modules. Find a full ESD description in chapter 18.

Duration:  
1 hour



*Always wear an antistatic wristband in direct contact with your skin. Connect the alligator clip to the blank metal of the rack or plug the antistatic wristband into the ESD bonding point.*

#### Installation Equipment

- ▶ Key of the rack (if necessary)
- ▶ Screwdriver set, cable ties, cable tool set and Fiber cleaning tool
- ▶ Antistatic wristband
- ▶ 2-OLS module
- ▶ Interface cable(s) and fiber optic patch cords
- ▶ Extra documentation can be found in chapter 15

Compatibility		XT-1104-A/XT-2206-A/ XT-2209-A/XT-2210-A	Weight: approx. 0.23 kg / 0.5 lb
---------------	--	---	-------------------------------------

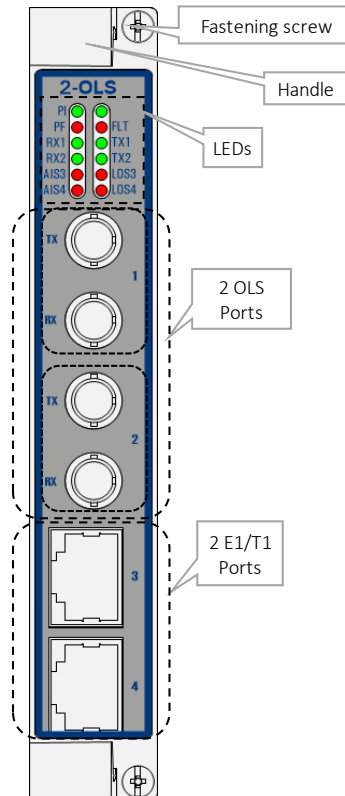

#### Front Panel



#### Installation

1. Remove the ESD packaging from the interface module, do not touch or bend the EMC spring on the side of the front panel.
2. Identify the node and the interface slot where the module has to be installed, see corresponding node form.

3. Take the 2-OLS module with the front panel handles, aim correctly and slide it through the correct card guides (see chapter §3.4) into the allocated slot.
4. Push the module as far as possible into the node.
5. Push firmly with your thumbs on the front panel for optimal backplane contact.
6. Tighten the two fastening screws.
7. Plug the interface cable(s) into the corresponding connector(s) (see next page(s) for pin numbers, signal names and color codes).

Engineer type	Section	Form: Operation of a 2-OLS module
 <p>Duration: 10 min.</p>	<p><b>ESD</b></p>	<p>With all installation activities, adopt the ESD recommendations regarding the handling, transportation and storage of modules. Find a full ESD description in chapter 18.</p> <div style="display: flex; align-items: center; justify-content: center;">  <p><i>Always wear an antistatic wristband in direct contact with your skin. Connect the alligator clip to the blank metal of the rack or plug the antistatic wristband into the ESD bonding point.</i></p> </div>
	<p><b>Installation Equipment</b></p>	<ul style="list-style-type: none"> <li>▶ Key of the rack (if necessary)</li> <li>▶ Screwdriver set, cable ties and cable tool set</li> <li>▶ Antistatic wristband and Fiber cleaning tool</li> <li>▶ Extra documentation can be found in chapter 15</li> </ul>
	<p><b>Operation</b></p>	<ol style="list-style-type: none"> <li>1. The 2-OLS module does not require any settings, straps or adjustments prior to the installation.</li> <li>2. Check whether the links are up via the LEDs, info on the LEDs via manuals listed in §15.</li> <li>3. Call the control center to check whether the 2-OLS module is functioning properly after having it programmed in HiProvision.</li> </ol>
	<p><b>Connect Fibers</b></p>	<ol style="list-style-type: none"> <li>1. Clean the front face and the ferrule of the optical fiber connector with a fiber cleaning tool.</li> <li>2. Connect the optical fibers (ST connectors) to an ST Optical Serial port on the 2-OLS front panel.</li> <li>3. Check the RX(1-2) and TX (1-2) LED, info on the LEDs via manuals listed in §15.</li> </ol>
	<p><b>Program 2-OLS Module</b></p>	<div style="display: flex; align-items: center; justify-content: center;">  <p>A trained HiProvision administrator must perform the HiProvision steps below in the control center. A full description of the steps below can be found in 'Dragon PTN and HiProvision Operation' manual, see chapter 15.</p> </div> <ol style="list-style-type: none"> <li>1. Use your cell phone to communicate with the control center and ask them to program the 2-OLS in HiProvision.</li> </ol>

2. In HiProvision, discover the network elements and links in the Dragon PTN Network.
3. In HiProvision, approve the Dragon PTN Network.
4. In HiProvision, configure all the network elements and links in the database. This could be done automatically via the discover and approve steps, or it can be done manually.
5. In HiProvision, program tunnels;
6. In HiProvision, program services;
7. Contact the control center to check if the 2-OLS is functioning properly after having it discovered and programmed in HiProvision.

## 2-OLS CABLING

The 2-OLS module provides two E1 RJ-45 ports and each port connector has eight pins. Each port provides one tip/ring pair. See the table and figure below for an overview and description.

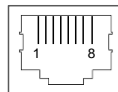



### E1 Cable (120 Ω) 942 256-201

#### Color Codes, Pin Numbers, Signal Names

Color	Signal Name	Pin Number
OG	Rx (Receive) RING	1
WH/OG	Rx (Receive) TIP	2
-	Not connected	3
BU	Tx (Transmit) RING	4
WH/BU	Tx (Transmit) TIP	5
-	Not connected	6
-	Not connected	7
-	Not connected	8

## 7.14 9-L3A-L (942 236-005)

Engineer type	Section	Form: Installation of a 9-L3A-L module	
 <p>Duration: 1 hour</p>	<p><b>ESD</b></p>	<p>With all installation activities, adopt the ESD recommendations regarding the handling, transportation and storage of modules. Find a full ESD description in chapter 18.</p>	<p><i>Always wear an antistatic wristband in direct contact with your skin. Connect the alligator clip to the blank metal of the rack or plug the antistatic wristband into the ESD bonding point.</i></p>
	<p><b>Installation Equipment</b></p>	<ul style="list-style-type: none"> <li>▶ Key of the rack (if necessary)</li> <li>▶ Screwdriver set, cable ties, cable tool set and Fiber cleaning tool</li> <li>▶ Antistatic wristband</li> <li>▶ 9-L3A-L module + SFP and XFP module</li> <li>▶ Interface cable(s) and fiber optic patch cords</li> <li>▶ Extra documentation can be found in chapter 15</li> </ul>	
	<p><b>Compatibility</b></p>	<p> <b>XT-1104-A/XT-2206-A/ XT-2209-A/XT-2210-A</b></p>	<p>Weight: approx. 0.630 kg / 1.4 lb</p>
	<p></p>	<p><b>XT-2209-A node:</b></p> <ul style="list-style-type: none"> <li>▶ IFM[1,2]: can not be used, reserved for Layer3 extension board (future);</li> <li>▶ IFM[2,3]: can not be used;</li> <li>▶ IFM[3,4]: Full operation, 14 Gbps bandwidth (4*1G + 10G);</li> <li>▶ IFM[5,6], [6,7], [7,8]: Limited operation, 1 Gbps bandwidth (1*1G), no 10G;</li> <li>▶ IFM[8,9], [9,10]: Limited operation, 4 Gbps bandwidth (4*1G), no 10G;</li> </ul> <p><b>Other nodes:</b></p> <ul style="list-style-type: none"> <li>▶ IFM[1,2], [2,3], [3,4], [9,10]: Limited operation, 4 Gbps bandwidth (4*1G), no 10G;</li> <li>▶ IFM[5,6], [6,7], [7,8], [8,9]: Limited operation, 1 Gbps bandwidth (1*1G), no 10G;</li> </ul>	



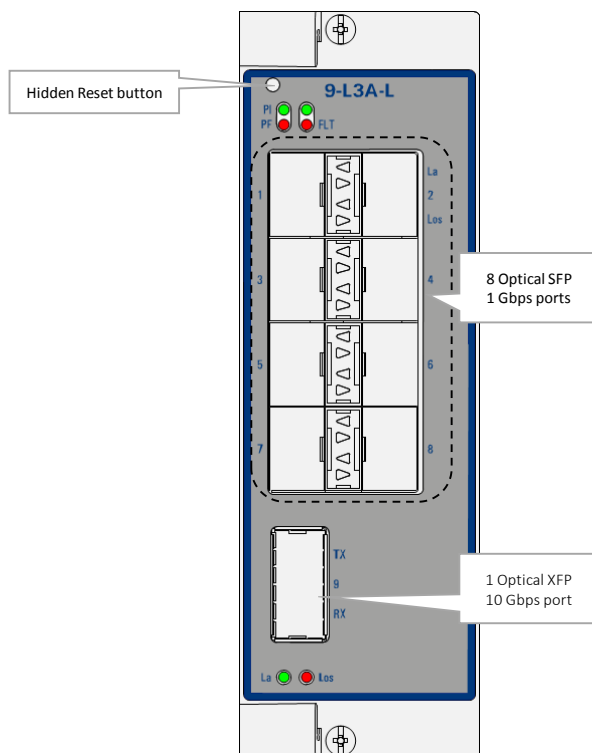

## Front Panel



## Installation

1. Remove the ESD packaging from the interface module, do not touch or bend the EMC spring on the side of the front panel.
2. Identify the node and the interface slot where the module has to be installed, see corresponding node form.
3. Take the 9-L3A-L module with the front panel handles, aim correctly and slide it through the correct card guides (see chapter §3.4) into the allocated slot.
4. Push the module as far as possible into the node.
5. Push firmly with your thumbs on the front panel for optimal backplane contact.
6. Tighten the two fastening screws.
7. Plug the SFP/XFP modules in the corresponding position (see §7.15).
8. Plug the interface cable into the corresponding connector (see next page(s) for pin numbers, signal names and color codes).

Engineer type	Section	Form: Operation of a 9-L3A-L module
 Duration: 10 min.	<b>ESD</b>	<p>With all installation activities, adopt the ESD recommendations regarding the handling, transportation and storage of modules. Find a full ESD description in chapter 18.</p> <div style="display: flex; align-items: center;">  <div style="margin-left: 10px;"> <p><i>Always wear an antistatic wristband in direct contact with your skin. Connect the alligator clip to the blank metal of the rack or plug the antistatic wristband into the ESD bonding point.</i></p> </div> </div>

- 
- |                               |   |
|-------------------------------|---|
| <b>Installation Equipment</b> | <ul style="list-style-type: none"><li>▶ Key of the rack (if necessary)</li><li>▶ Screwdriver set, cable ties and cable tool set</li><li>▶ Antistatic wristband and Fiber cleaning tool</li><li>▶ Extra documentation can be found in chapter 15</li></ul> |
|-------------------------------|---|
- 

- |                  |   |
|------------------|---|
| <b>Operation</b> | <ol style="list-style-type: none"><li>1. The 9-L3A-L module does not require any settings, straps or adjustments prior to the installation.</li><li>2. Connect the optical fibers, see section below.</li><li>3. Check whether the links are up via the LEDs, info on the LEDs via manuals listed in §15.</li><li>4. Call the control center to check whether the 9-L3A-L module is functioning properly after having it programmed in HiProvision.</li></ol> |
|------------------|---|
- 

- |                       |   |
|-----------------------|---|
| <b>Connect Fibers</b> | <ol style="list-style-type: none"><li>1. Insert the optical modules in the corresponding TRMs (see form in §7.15). If already pre-installed, go to step 2.</li><li>2. Label the optical fibers. Example: see picture below.</li><li>3. Clean the front face and the ferrule of the optical fiber connector with a fiber cleaning tool.</li><li>4. Connect the optical fibers (LC connectors) to the XFP/SPF ports on the 9-L3A-L front panel.</li><li>5. Check the LA LEDs, info on the LEDs via manuals listed in §15.</li></ol> |
|-----------------------|---|
- 

<b>Program 9-L3A-L Module</b>	
-------------------------------	--



A trained HiProvision administrator must perform the HiProvision steps below in the control center. A full description of the steps below can be found in 'Dragon PTN Operation' manual, see chapter 15.

---





1. Use your cell phone to communicate with the control center and ask them to program the 9-L3A-L in HiProvision.
  2. In HiProvision, discover the network elements and links in the Dragon PTN Network.
  3. In HiProvision, approve the Dragon PTN Network.
  4. In HiProvision, configure all the network elements and links in the database. This could be done automatically via the discover and approve steps, or it can be done manually.
  5. In HiProvision, program tunnels;
  6. In HiProvision, program services;
  7. Contact the control center to check if the 9-L3A-L is functioning properly after having it discovered and programmed in HiProvision.
- 

## 9-L3A-L CABLING

The 9-L3A-L module has only an optical connector on the front side and therefore thus not requires any other cables.

---

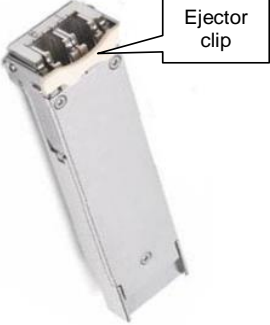
## 7.15 Optical Transceiver/Receiver Modules (SFP, XFP)

Engineer type	Section	Form: Installation of an optical module
  Duration: 30 min.	<b>ESD</b>	<p>With all installation activities, adopt the ESD recommendations regarding the handling, transportation and storage of modules. Find a full ESD description in chapter 18.</p> <div style="display: flex; align-items: center;">  <p><i>Always wear an antistatic wristband in direct contact with your skin. Connect the alligator clip to the blank metal of the rack or plug the antistatic wristband into the ESD bonding point.</i></p> </div>
<b>Installation Equipment</b>		<ul style="list-style-type: none"> <li>▶ Key of the rack (if necessary)</li> <li>▶ Screwdriver set</li> <li>▶ Antistatic wristband</li> <li>▶ SFP, XFP modules delivered by Hirschmann</li> <li>▶ Extra documentation can be found in chapter 15</li> </ul>
<b>Plug in SFP/XFP Module</b>		<div style="display: flex; justify-content: space-between;"> <div style="width: 45%;">  <p style="text-align: center;"><b>Optical SFP Module</b></p>  <p style="text-align: center;"><b>Optical XFP Module for 1-10G-LW</b></p> </div> <div style="width: 50%;"> <ol style="list-style-type: none"> <li>1. Consult your optical network drawing to determine the correct SFP, XFP modules in the correct interface modules.</li> <li>2. Remove the packaging from the optical module.</li> <li>3. Identify the interface module, where the optical module has to be inserted.</li> <li>4. Consult the general recommendations in chapter §7.1 before installing the optical module.</li> <li>5. Plug in the optical module into the reserved position.</li> <li>6. Close the ejector clip until you hear a click to lock the optical module properly.</li> </ol> </div> </div> <hr/> <div style="text-align: center;">  <p><b>ATTENTION!</b> When installing an SFP, XFP module, avoid looking straight into this SFP, XFP module.</p> </div>

## Cables

## 8. CABLES

### 8.1 Introduction

See the chapters of the modules itself to find out which cables must be used.

### 8.2 Color Codes

The table below provides an overview of the color codes of the cables according to IEC 757.

Color Code	Color	Color Code	Color
RD	Red	BK	Black
BU	Blue	OG	Orange
YE	Yellow	VT	Violet
GN	Green	PK	Pink
BN	Brown	TQ	Turquoise
GY	Slate	SR	Silver
WH	White		

## **Add New Node to a Live Network**

## 9. ADD NEW NODE TO A LIVE NETWORK

### 9.1 Introduction

Follow the steps below to expand your Dragon PTN network with a new node.

### 9.2 Steps

Prerequisites: At least the NSM, one PSU and one CSM have been plugged in into the new powered-down node.

1. Do not connect the node yet into the network;
2. Pull out the NSM and set the correct node number on the rotary DIP switches, valid node number = [1...8999];
3. Plug in the NSM into the node;
4. Power up the node;
5. Factory reset the node via pushing the hidden reset button on the CSM for at least 7 seconds. The node will reboot and FAC RST must appear on the display during the reboot;
6. When the node has rebooted after factory reset, the configured NSM node number must appear on the CSM display;
7. (optional) After the reboot, power down the node if the node has been prepared on location A (e.g. in the lab) and must be moved to another location B in the network. Move and power up;
8. Connect the node into the Dragon PTN WAN network via connecting the WAN links between the new node and the existing network. WAN links are connected on the 1-10G-LW / 4-GC-LW / 4-GCB-LW / 4-GO-LW modules;
9. The new node and links will be automatically discovered in HiProvision via the Discovery tile. Click the Update/Layout button  to update and layout the discovered nodes properly;
10. Approve the discovered node and links in the Discovery tile;
11. Auto create the new node and links in the database in the Discovery tile;
12. Your node is ready to participate in the Dragon PTN network. Services can be created on the plugged in IFMs.

## **Installation File**





## **Third-Party Equipment**

## **11. THIRD-PARTY EQUIPMENT**

Besides all the Dragon PTN equipment, add detailed installation instructions of possible third-party equipment to this manual.

## Repair

## 12. REPAIR

Information on the handling of complaints can be found on the Internet:

<http://www.beldensolutions.com/en/Service/Repairs/index.phtml>

## **Final Installation Activities**

### 13. FINAL INSTALLATION ACTIVITIES

On completion of the installation of the Dragon PTN equipment, perform the following actions.

Step no.	Description
1	Wipe all surfaces of the Dragon PTN rack, to remove any dirt, grease or blemishes
2	Close and lock the door of the rack
3	Sweep and tidy the work area

## **Preventive Maintenance**



## 14. PREVENTIVE MAINTENANCE

Because Dragon PTN provides maximum network availability, it is still recommended to implement a preventive maintenance procedure for an optimal performance of the Dragon PTN network. The actions below can be part of the preventive maintenance procedure for Dragon PTN.

- ▶ **Dynamic environment:** Execute this procedure every month. The Dragon PTN network is reconfigured at least once a week. This includes re-layout of the network, configuring new services, nodes or modules.
- ▶ **Static environment:** Execute the procedure every 4 months. The Dragon PTN network is very rarely reconfigured.

### 14.1 Visual Inspection of the Equipment

- ▶ Check the rack, if installed outdoor, for possible water leakages or other failings.
- ▶ Check the power distribution fuses, circuit breakers and earthing connection of the node(s).
- ▶ Check that all cables are properly attached to the Dragon PTN equipment and that the minimum bending radius for all cables is respected.
- ▶ Check Dragon PTN nodes and modules for alarms (i.e. red LEDs) and solve them.
- ▶ Make sure the equipment and its environment is kept clean.
- ▶ Check whether all cabling towards external equipment is properly labeled.

### 14.2 Measure Network Path Delays and Message Loss

In HiProvision, network path delays and message loss between two end-points of a service can be measured via the OAM tool (=Operation, Administration and Maintenance). The OAM Tool can be found via HiProvision → Monitoring → Network → Services → Measure.

### 14.3 Optical Measurements

HiProvision measures the **optical receive levels** (in dBm) on the SFPs. No fibers must be pulled out for optical measurements. HiProvision shows the measured values on port level of the interface modules.

### 14.4 Test Node PSU Redundancy and UPS (Uninterruptable Power Supply)

In most cases: One node PSU is fed by the net power or powerline1. The other node PSU is fed by a UPS that by itself is fed by the net power or a separate powerline2.

#### 14.4.1 Test Node PSU Redundancy, Load Sharing



**If the test below fails, the node could go down!**

---

If both node PSUs are up and running, the load is shared over the two PSUs. Switch off one node PSU. As a result, the other node PSU must take over automatically and deliver the full power to the node without interrupting the node. Do the same test with the other node PSU.

#### 14.4.2 Test UPS

---



**If the test below fails, the node could go down!**

---

If both node PSUs are up and running, the load is shared over the two PSUs. If the UPS is fed by a powerline, the UPS will bypass this power directly to the node PSU. Disconnect the powerline that feeds the UPS. As a result, the UPS will automatically deliver power to the node from its batteries without interrupting the node.

#### 14.5 HiProvision

- ▶ Solve the most urgent alarms that are raised in HiProvision;
- ▶ Check log and alarm journal files in HiProvision for possible alarms/error messages;
- ▶ Check the disk space on the HiProvision PC. If the space is less than 10% of the total capacity, delete alarm and event journal files starting with the oldest ones;
- ▶ Backup the HiProvision database regularly via HiProvision. Create a '\*.bak' backup file;

#### 14.6 Helpdesk

Contact the helpdesk via <https://hirschmann-support.belden.eu.com>.

#### 14.7 System Documentation

Check whether the documentation or plans are still up-to-date:

- ▶ rack/node configurations
- ▶ network layout
- ▶ services
- ▶ fiber & copper connections

#### 14.8 Repair Stock

Check the stock of Dragon PTN spare parts on a yearly base and order extra parts if necessary. Keep an MTBF report of the installed network.

#### 14.9 Health Check and System Upgrade

Make sure to update the operating system and firewall of the HiProvision server on a regular base. Install patches if necessary. Check the health of your network. Contact the helpdesk (see above) to check if the HiProvision and network has to be updated.

## Reference List

## 15. MANUALS REFERENCE LIST

All these manuals can be found in the HiProvision (=Dragon PTN Management System) Help function or on the Portal (= <https://hiprovision.hirschmann.com>)

Products	Manual Reference number (&=language code; *=issue)
<b>General (Software + Hardware)</b>	
Dragon PTN and HiProvision Operation	DRA-DRM821-&-*
<b>Nodes (+Power supplies)</b>	
XT-1104-A/XT-2206-A/XT-2209-A/XT-2210-A Node	DRB-DRM802-&-*
<b>Node Support Modules</b>	
NSM-A/NSM-B	DRB-DRM802-&-*
<b>Central Switching Module</b>	
CSM310-A	DRD-DRM803-&-*
<b>Interface Module</b>	
4-E1-L/4-T1-L	DRE-DRM805-&-*
4-DSL-LW	DRE-DRM806-&-*
4-GC-LW/4-GCB-LW	DRE-DRM807-&-*
2-C37.94	DRE-DRM809-&-*
7-SERIAL	DRE-DRM813-&-*
1-10G-LW	DRE-DRM808-&-*
4-2/4WEM	DRE-DRM814-&-*
4-CODIR	DRE-DRM816-&-*
4-GO-LW	DRE-DRM817-&-*
2-OLS	DRE-DRM815-&-*
16-E1-L/16-T1-L	DRE-DRM818-&-*
8-FXS	DRE-DRM819-&-*
9-L3A-L	DRE-DRM823-&-*

&	Language
E	English
G	German
F	French
D	Dutch
P	Portuguese
R	Russian
S	Spanish

## **Abbreviations List**

## 16. ABBREVIATIONS LIST

<b>BNC</b>	Bayonet Neill–Concelman
<b>CE</b>	Conformité Européenne
<b>CES</b>	Circuit Emulation Service
<b>CO</b>	Central Office
<b>CPE</b>	Customer Premises Equipment
<b>CSM</b>	Central Switching Module
<b>DI</b>	Digital Input
<b>DIN</b>	Deutsches Institut für Normung
<b>DCD</b>	Data Carrier Detect
<b>DCE</b>	Data Communication Equipment
<b>DO</b>	Digital Output
<b>DSR</b>	Data Set Ready
<b>DTE</b>	Data Terminal Equipment
<b>DTR</b>	Data Terminal Ready
<b>EMC</b>	Electromagnetic Compatibility
<b>ERO</b>	Equipment Repair Order
<b>ESD</b>	Electrostatic Discharge
<b>FGND</b>	Frame Ground
<b>GND</b>	Ground
<b>IEC</b>	International Electrotechnical Commission
<b>IEEE</b>	Institute of Electrical and Electronics Engineers
<b>IFM</b>	InterFace Module
<b>LAN</b>	Local Area Network
<b>LA</b>	Link Activity
<b>LT</b>	Line Termination
<b>LVD</b>	Low Voltage Directive
<b>NSM</b>	Node Support Module
<b>NT</b>	Network Termination
<b>OAM</b>	Operations, Administration and Maintenance
<b>PCB</b>	Print Circuit Board
<b>PD</b>	Power Device
<b>PE</b>	Protective Earth
<b>PI</b>	Power Input
<b>PoE</b>	Power Over Ethernet
<b>PSC</b>	Protection State Coordination
<b>PSE</b>	Power Source Equipment
<b>PSI</b>	Power Supply Input
<b>PSO</b>	Power Supply Output
<b>PSU</b>	Power Supply Unit
<b>PTN</b>	Packet Transport Network
<b>RDI</b>	Remote Defect Indication
<b>RMA</b>	Return Merchandise Authorization
<b>SDH</b>	Synchronous Digital Hierarchy
<b>SFP</b>	Small Form-factor Pluggable
<b>SHDSL</b>	Symmetrical High Bitrate Digital Subscriber Line
<b>TRM</b>	Transmit Receive Module

<b>UPS</b>	Uninterruptable Power Supply
<b>WAN</b>	Wide Area Network
<b>WEEE</b>	Waste of Electrical and Electronic Equipment
<b>WPH</b>	WAN PHY, Packet Over SDH

## General Node Data



## 17. GENERAL NODE DATA

General Node Data (See also 'Introduction → Administration' section for more details)										
<b>Node</b>	<input type="checkbox"/> XT-1104-A	<input type="checkbox"/> XT-2206-A	<input type="checkbox"/> XT-2209-A	<b>NSM</b>		<b>PSU</b>	<input type="checkbox"/> PSU-1	<input type="checkbox"/> PSU-2		
HW ed.	.....			<input type="checkbox"/> XT-2210-A	HW ed.	.....		HW ed.	.....	
Serial No.	.....			Serial No.	.....		Serial No.	.....		.....
<b>CSM</b>		<input type="checkbox"/> CSM310-A								
		CSM-1			CSM-2*					
Hardware Edition	.....			.....						
Serial Number	.....			.....						
Ethernet Address	.....			.....						
<b>IFM</b>										
<b>Position</b>	<b>Type</b>	<b>Hardware Edition</b>	<b>Serial Number</b>	<b>Transceiver Modules</b>	<b>Type</b>	<b>Hardware Edition</b>	<b>Serial Number</b>			
<b>IFM-1</b>	.....	.....	.....	SFP	.....	.....	.....			
<b>IFM-2</b>	.....	.....	.....	SFP	.....	.....	.....			
<b>IFM-3</b>	.....	.....	.....	SFP/XFP	.....	.....	.....			
<b>IFM-4***</b>	.....	.....	.....	SFP	.....	.....	.....			
<b>IFM-5*</b>	.....	.....	.....	SFP/XFP	.....	.....	.....			
<b>IFM-6*</b>	.....	.....	.....	SFP/XFP	.....	.....	.....			
<b>IFM-7**</b>	.....	.....	.....	SFP/XFP	.....	.....	.....			
<b>IFM-8**</b>	.....	.....	.....	SFP/XFP	.....	.....	.....			
<b>IFM-9**</b>	.....	.....	.....	SFP	.....	.....	.....			
<b>IFM-10**</b>	.....	.....	.....	SFP	.....	.....	.....			
<b>HW ed.</b> = Hardware Edition <b>Serial No.</b> = Serial Number * = not available in XT-1104-A ** = not available in XT-1104-A and XT-2206-A *** = not available in XT-2209-A <b>NSM: Node Support Module / IFM: Interface Module / PSU: Power Supply Unit / CSM: Central Switching Module</b>										

## **ESD Recommendations**

## 18. ESD RECOMMENDATIONS

### 18.1 General

This document describes guidelines and precautions for handling, storing and transporting printed circuits which may be damaged or destroyed when subjected to electrostatic discharges.

It is the purpose to prevent damage by electrostatic discharges by using suitable identification labels, packaging material, workshop equipment, clothing and personnel training.

An electrostatic discharge is a transfer of an electrostatic charge between two bodies having a different electrostatic potential, due to direct contact or to induction of another electrostatic field.

Units that are sensitive to electrostatic discharges are marked worldwide by the abbreviation 'ESD', which stands for Electro Static Discharge. ESD units may be damaged or destroyed by static charges as low as 100 Volts. The charges carried by the human body can be a thousand times higher. Consequently, the guidelines and precautions described in this document are to be complied with strictly.

Additional information is to be found in document DOD-HDBK-263: 'Electrostatic Discharge Control Handbook'.

Some important items are defined in this standard:

- a. ESD-PROTECTIVE MATERIAL: raw materials which and/or
  - ▶ limit the generation of static electricity;
  - ▶ provide for a rapid dissipation of electrostatic charges over surface or volume;
  - ▶ form a shield against discharge sparks or against electrostatic fields.
- b. CONDUCTIVE MATERIAL: ESD protective material with a surface resistivity of  $10^5 \Omega$  per surface unit.
- c. STATIC DISSIPATIVE MATERIAL: ESD protective material with a surface resistance of  $10^5$  to  $10^9 \Omega$  per surface unit.
- d. ANTI-STATIC MATERIAL: ESD protective material with a surface resistivity of  $10^9$  to  $10^{14} \Omega$  per surface unit.
- e. INSULATIVE MATERIAL: material with a surface resistivity  $> 10^{14} \Omega$  per surface unit.

### 18.2 Identification and Packaging of ESD Modules

Printed circuits sensitive to static discharges shall be clearly marked to indicate that they are to be handled with care at all times. Hirschmann selected as their warning label the international 'EIA' symbol on a yellow background, represented in the figure below.

#### 18.2.1 Static Protective Packaging

It must be possible for all ESD modules to be identified as such by means of the type of packaging.

The static protective packaging shall comply with the following requirements:

- a. Packaging material: all conductive - and in specific cases static dissipative - materials are suited.

- b. The packaging **MUST** be closed, i.e. the ESD modules must be protected against touching.
- c. While in the packaging, the ESD modules shall be prevented from being charged. They shall be protected as if they were contained in a Faraday cage.



**Hirschmann ESD Warning Labels**

- d. The ESD identification must be such that it is visible before opening the packaging.
- e. Ordinary plastic bags, styropore and similar insulating materials are **NOT ALLOWED**. To be avoided is the use of either conductive polystyrene foam with carbon additive or of aluminum foil, as they go brittle after multiple use and may leave conductive residues which could cause short-circuits.

The following 'Static protective packaging's are to be used for ESD modules:

- a. Conductive transparent plastic bag (bearing the ESD label).
- b. Structure:
  - ▶ Rub-off layer
  - ▶ Metallized outer layer
  - ▶ PE layer
  - ▶ Anti-static inner layer

All conductive or static protective packaging's used to contain ESD modules shall be clearly marked with the ESD label or the EIA label as represented in the figure below.

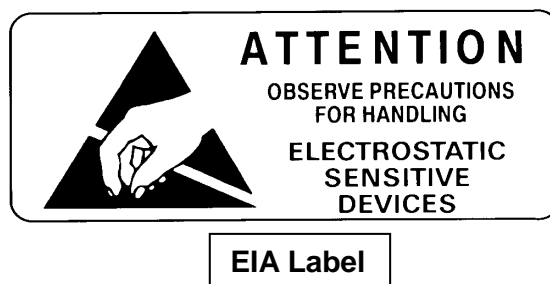

Components which were treated with anti-static agents shall be marked with the STATICIDE label represented in in the figure below. As the effect of the anti-static treatment is only temporary and depends of the RH %, the treatment needs to be repeated at regular intervals.

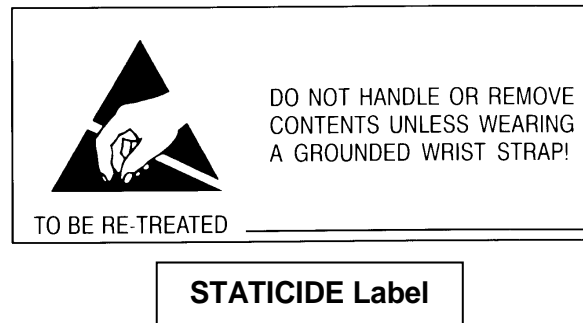

### 18.3 Handling of ESD Modules

#### 18.3.1 General Guidelines and Precautions

ESD modules shall be handled only in protected workshops by trained and properly grounded personnel. Outside these protected workshops, the ESD modules shall always be placed inside a static protective packaging.

While handling ESD modules, the following ambient conditions need to be avoided:

- a. Ambient temperatures  $> 40^{\circ}\text{C}$
- b. RH  $< 30\%$
- c. Ultrasonic vibrations  $< 30\text{ kHz}$
- d. Currents of warm air

#### 18.3.2 ESD Guidelines upon Receipt

Check whether the ESD modules are contained in a static protective bag and whether the correct ESD indications are applied. During these checks, the PACKAGING SHALL REMAIN CLOSED.

When the packaging needs to be opened, this shall only be done in a protected workshop by trained, properly grounded personnel.

As soon as an ESD module is removed from the packaging, direct contact with any static discharge source such as non-grounded personnel, ordinary plastic materials, synthetic clothing, etc. must be avoided.

#### 18.3.3 Handling

The conditions regarding a protected workshop are complied within the following situations:

1. Always wear the prescribed work clothes:
  - ▶ Anti-static work clothes consisting of (at least) 50 % cotton or equivalent fabric; static charge caused by friction shall be  $< 100\text{ V}$ .
  - ▶ Grounded wrist strap, with incorporated resistor for personal protection, contacting both skin and ground.

2. ESD modules, which are NOT contained in an antistatic protective packaging shall not be used without testing previously.
3. ESD modules shall NEVER be touched when there is a difference of potential.
4. Prior to removing modules from the static protective packaging, place it on a conductive working surface or hold it against a grounded frame, in order to discharge possible charges on the exterior.
5. NEVER remove ESD modules from the packaging, except on the static dissipating or anti-static working surface.

**NOTE:** Pay attention when using adhesive tape (slowly pull loose) and rubber gloves (not near ESD modules or when removing modules).

6. ESD modules shall only leave the protected area inside the proper static protective packaging.
7. As the rules to be applied are more extensive, and as the application of the precautions are personnel dependent, special training and close supervision are necessary.

#### **18.3.4 Protective Guidelines for Workshop Equipment**

When possible damage or destruction by electric fields or electrostatic discharges is to be excluded, the proper work-shop equipment is required. This can be achieved by using materials, tools and instruments which undoubtedly have the same potential as the workstations. Make sure that all metal parts of the workstation are electrically interconnected and are grounded via a central grounding point. Miscellaneous objects such as plastic bags, cups, bottles and similar insulating materials are NOT allowed on the workstation. Whether certain materials, tools and instruments are suited for ESD prevention needs to be checked at regular intervals.

The floor shunt resistance (RE) is important in avoiding electrostatic charging and draining. Basically, every type of floor is suitable for an individual ESD workstation, where the personnel use a grounded wrist strap. However, it is recommended to provide a conducting floor grounded by means of a protective resistance, underneath the workstation, when  $RE \leq 10^7 \Omega$ . In a protected area, RE MUST BE  $< 10^7 \Omega$ .

#### **18.4 Storage of ESD Modules**

ESD modules are to be kept in their original static protective packaging.

#### **18.5 Transportation of ESD Modules**

ESD modules NEED to be transported in their static protective packaging.

## 18.6 Handling and Transportation of Racks and Systems

Racks and systems are always packed in a static protective packaging with distinct ESD indication.

The floor covering of an installation must always be made-out of a substance which prevents build-up of static charges. Wooden parquet floors or stone floors are recommended. If a floor covering is used on which static charges may build up, the use of a special conductive floor mat is recommended. The ground shunt of the floor (RE) MUST always be  $< 10^7 \Omega$ .

Upon installation of a rack or system, every contact with a connector or the wiring is to be avoided. Grounding needs to be done immediately after the rack is installed. As soon as modules and wiring are to be manipulated, the guidelines and precautions described in Chapter 18.3 must be applied.

## 18.7 Summary of Rules to be Obeyed

The following rules need to be complied with:

- a. Train all personnel on the correct application of ESD precautions and frequently check everybody as far as the implementation is concerned.
- b. Mark all ESD equipment.
- c. Insist on a static protective packaging for all incoming ESD modules and refuse every incoming product which is not properly packed.
- d. Protect all ESD equipment during packaging, transportation and storage.
- e. Always wear the prescribed work clothes: anti-static work clothes (cotton > 50 %) and grounded wrist strap, with incorporated resistor, which contacts both skin and ground.
- f. Never work on the system without proper grounding.
- g. Keep modules inside the static protective bags as long as possible.
- h. Put the modules immediately back into the static protective packaging if they are removed from the cabinet.
- i. Handle the modules by the edges only.
- j. Avoid contact with connector tabs and components on the module.
- k. Avoid contact between the module and plastics or textiles.