



HIRSCHMANN

A **BELDEN** BRAND

User Manual

Installation Industrial Ethernet Ruggedized Switch MACH 1000 Family



MACH 1020

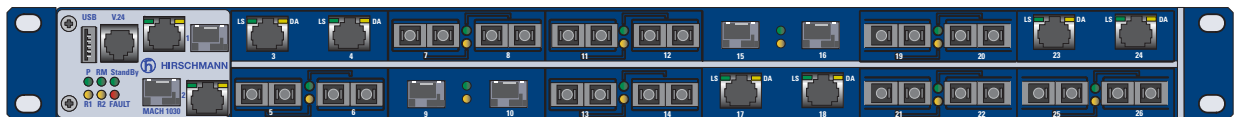

MACH 1030

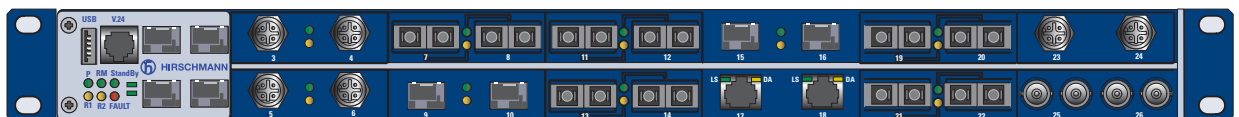

MACH 1032

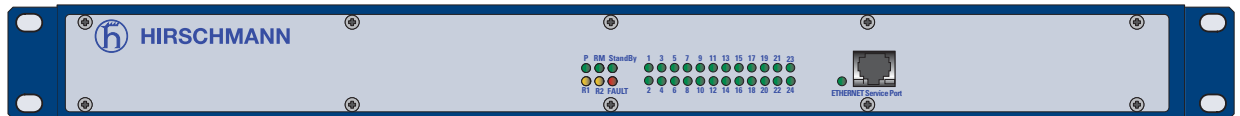
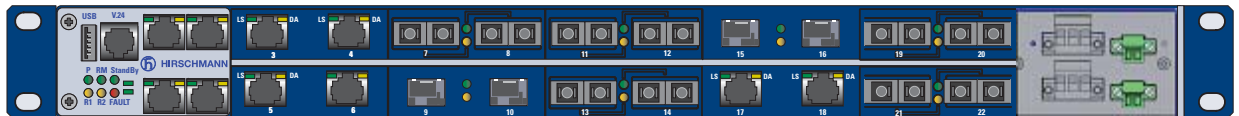

MACH 1132



039687003030415000

The naming of copyrighted trademarks in this manual, even when not specially indicated, should not be taken to mean that these names may be considered as free in the sense of the trademark and tradename protection law and hence that they may be freely used by anyone.

© 2015 Hirschmann Automation and Control GmbH

Manuals and software are protected by copyright. All rights reserved. The copying, reproduction, translation, conversion into any electronic medium or machine scannable form is not permitted, either in whole or in part. An exception is the preparation of a backup copy of the software for your own use. For devices with embedded software, the end-user license agreement on the enclosed CD/DVD applies.

The performance features described here are binding only if they have been expressly agreed when the contract was made. This document was produced by Hirschmann Automation and Control GmbH according to the best of the company's knowledge. Hirschmann reserves the right to change the contents of this document without prior notice. Hirschmann can give no guarantee in respect of the correctness or accuracy of the information in this document.

Hirschmann can accept no responsibility for damages, resulting from the use of the network components or the associated operating software. In addition, we refer to the conditions of use specified in the license contract.

You can get the latest version of this manual on the Internet at the Hirschmann product site (www.hirschmann.com).

Hirschmann Automation and Control GmbH
Stuttgarter Str. 45-51
72654 Neckartenzlingen
Germany
Tel.: +49 1805 141538

Contents

Safety instructions	5
About this Manual	14
Legend	14
1 Description	15
1.1 General device description	15
1.2 Combination options	16
1.3 Description of the device variants	19
1.3.1 Front view of the MACH 1000 with 2 Gigabit ports	20
1.3.2 Front view of the MACH 1000 with 4 Gigabit ports (SFP)	21
1.3.3 Front view of the MACH 1000 with 4 Gigabit ports (2 x SFP and 2 x RJ45)	22
1.3.4 Front view of the MACH 1000 with PoE	23
1.3.5 Views of the MACH 1000, ports in the back	24
1.3.6 Connections for voltage-carrying lines	25
1.3.7 MACH 1000 devices with PoE	28
1.4 Ethernet ports	28
1.4.1 10/100/1000 Mbit/s twisted pair port	28
1.4.2 10/100 Mbit/s twisted pair port	29
1.4.3 10/100 Mbit/s PoE port	29
1.4.4 1000 Mbit/s F/O port	30
1.4.5 100 Mbit/s F/O port	30
1.4.6 10 Mbit/s F/O port	30
1.4.7 Pin assignments	31
1.5 Display elements	32
1.5.1 Device state	32
1.5.2 Port state	34
1.6 Management interfaces	35
1.6.1 V.24 interface (external management)	35
1.6.2 USB interface	35
1.7 Signal contact	36
2 Installation	37
2.1 Checking the package contents	37
2.2 Connecting the power unit connections for supply voltage and signal contact	37

2.2.1	Connecting the voltage supply terminals (power supply units “C” and “G”)	37
2.2.2	Connecting the plugged voltage supply (power supply units “L” and “M”)	40
2.2.3	Connecting the signal contact	42
2.3	Installing and grounding the device	43
2.3.1	Mounting in a switch cabinet	43
2.3.2	Vertical mounting on the wall	45
2.3.3	Grounding the device	46
2.4	Operating the device	46
2.5	Connecting data cables	46
2.5.1	Twisted Pair ports	46
2.5.2	Optical fiber ports	46
2.6	Installing an SFP transceiver (optional)	47
3	Making basic settings	48
4	Monitoring the ambient air temperature	49
5	Maintenance and service	50
6	Disassembly	51
6.1	Removing the device	51
6.2	Removing an SFP transceiver (optional)	51
7	Technical data	52
A	Further Support	65

Safety instructions



WARNING

UNCONTROLLED MACHINE ACTIONS

To avoid uncontrolled machine actions caused by data loss, configure all the data transmission devices individually.

Before you start any machine which is controlled via data transmission, be sure to complete the configuration of all data transmission devices.

Failure to follow these instructions can result in death, serious injury, or equipment damage.

■ General safety instructions

You operate this device with electricity. Improper usage of the device entails the risk of physical injury or significant property damage. The proper and safe operation of this device depends on proper handling during transportation, proper storage and installation, and careful operation and maintenance procedures.

- Before connecting any cable, read this document, and the safety instructions and warnings.
- Operate the device with undamaged components exclusively.
- The device is free of any service components. In case of a damaged or malfunctioning the device, turn off the supply voltage and return the device to Hirschmann for inspection.

■ Intended usage

- Use the product only for the application cases described in the Hirschmann product information, including this manual.
- Operate the product only according to the technical specifications. [See “Technical data” on page 52.](#)
- Connect to the product only components suitable for the requirements of the specific application case.

■ Installation site requirements

- Install this device solely in a switch cabinet or in an operating site with restricted access, to which maintenance staff have exclusive access.
- Mount the device horizontally in a cabinet or vertically on a flat surface. Operating the device as a table unit is inadmissible.
[See “General technical data” on page 52.](#)
- Install the device in a fire protected shell if you are mounting it vertically.
- If you are operating the device in a 19" switch cabinet: install sliding/mounting rails for supporting the weight of the device.
- When you are selecting the installation location, make sure you observe the climatic threshold values specified in the technical data.
- Use the device in an environment with a maximum pollution degree that complies with the specifications in the technical data.

■ Device casing

Only technicians authorized by the manufacturer are permitted to open the casing.

- Make sure there is at least 3.94 inches (10 cm) of space in front of the ventilation slits of the housing.
[See “General technical data” on page 52.](#)
- Never insert pointed objects (narrow screwdrivers, wires, etc.) into the device or into the connection terminals for electric conductors. Do not touch the connection terminals.
- Do not touch the housing during operation or shortly after switching off the device. Hot surfaces can cause injury.
- Operating the device in the maximum surrounding air temperature and stacking devices: When installing the device, make sure there is at least one free rack space (approx. 5 cm) above the device, because heat is discharged via the housing of the device.

■ Qualification requirements for personnel

- Only allow qualified personnel to work on the device.

Qualified personnel have the following characteristics:

- ▶ Qualified personnel are properly trained. Training as well as practical knowledge and experience make up their qualifications. This is the prerequisite for grounding and labeling circuits, devices, and systems in accordance with current standards in safety technology.
- ▶ Qualified personnel are aware of the dangers that exist in their work.
- ▶ Qualified personnel are familiar with appropriate measures against these hazards in order to reduce the risk for themselves and others.
- ▶ Qualified personnel receive training on a regular basis.

■ **National and international safety regulations**

- Verify that the electrical installation meets local or nationally applicable safety regulations.

■ **Grounding the device**

The device is grounded via the separate grounding screw on the back of the device.

- Use a wire diameter for the ground conductor that is no smaller than the diameter of the supply voltage connection, however of at least 1.0 mm² (AWG16).
- Ground the device before connecting any other cables.
- Disconnect the grounding only after disconnecting all other cables.

■ **Shielded ground**

The shielded ground wire of the twisted pairs cables is connected to the front panel as a conductor.

Beware of possible short circuits when connecting a cable section with conductive shield braiding.

■ **Supply voltage**

The supply voltage is electrically isolated from the housing.

Connect only a supply voltage that corresponds to the type plate of your device.

- Every** time you connect the electrical conductors, make sure that the following requirements are met:
 - ▶ The power supply conforms to overvoltage category I or II.
 - ▶ The power supply has an easily accessible disconnecting device (e.g., a switch or a plug). This disconnecting device is clearly identified. So in the case of an emergency, it is clear which disconnecting device belongs to which power supply cable.
 - ▶ The disconnecting device is clearly identified so that in the case of an emergency, it is clear which disconnecting device belongs to which line.
 - ▶ The electrical wires are voltage-free.
 - ▶ The ground screw on the back of the device is connected to the protective conductor.
 - ▶ There is a fuse in the outer conductor (AC) or the positive conductor (DC) of the voltage supply.
Regarding the properties of this fuse: [See “General technical data” on page 52.](#)
 - ▶ Supply with DC voltage: the fuse is suitable for a DC voltage.
 - ▶ If the neutral conductor (AC) or the negative conductor (DC) is not grounded: there is a fuse in each of the two wires.
 - ▶ The wire diameter of the power supply cable is at least 1 mm² (North America: AWG16) on the supply voltage input.

- ▶ The cross-section of the protective conductor is the same size as or bigger than the cross-section of the power supply cables.
- ▶ The cables used are permitted for the temperature range of the application case.
- ▶ Relevant for North America:
For use in Class 2 circuits, the copper wire conforms to class 1, 60/75 °C or 75 °C.

- Verify that the electrical installation meets locally or nationally applicable safety regulations.
- Use undamaged parts.
- Internal fuses are triggered only in the case of a detected error in the device. In case of damage or malfunction of the device, turn off the supply voltage and return the device to the plant for inspection.
- Only switch on the device when the housing is closed.
- First connect the ground screw on the back of the device with the protective conductor before you set up the other connections. When removing the connections, you remove the protective conductor last.
- For supply voltage connections with protective conductor connection:
First connect the protective conductor before connecting the wires for the supply voltage.
If your device comprises a 2nd supply voltage connection of this type:
First connect the protective conductor before connecting the wires for the supply voltages.

■ Use in Hazardous Locations

Relevant for use in explosion hazard areas of the Hazardous Locations category (Class I, Division 2):

This device is only suitable for use in explosion hazard areas of category "Class I, Division 2, Groups A, B, C, D" or for use in non-explosion hazard areas.

The maximum operating temperature (ambient air) is 70 °C for device variants with the designation: MAR1xxx-xxxxxxxxxxxxxxxxxxxxxxxxxxxxxxxxUxxxxx or MAR1xxxxxxxxxxxxxxxxxxxxxxxxxxxxxxxxFxxxxx, where x corresponds to the letters and numbers from the table of product designations (see page 27 "Combination options"). The maximum operating temperature (ambient air) is 60 °C for device variants with the designation: MAR1xxx-xxxxxxxxxxxxxxxxxxxxxxxxxxxxxxxxSxxxxx, where x corresponds to the letters and numbers from the table of product designations (see page 27 "Combination options").

For operation in explosion hazard areas of the Hazardous Locations category (Class I, Division 2), the following applies:



CLASS I; DIV. 2, GROUPS A, B, C, D
TEMPERATURE CODE T4
ENVIRONMENT:

Standard: 0 °C ... +60 °C

Extended: -40 °C ... +70 °C

List of standards: ISA 12.12.01, CSA C22.2 no. 213-M1987



Warning: When the USB port is being used, the device must be located in a housing that is locked by means of a tool.

Only disconnect devices when the system is voltage-free or is located in an area without inflammable concentrations or substances.

Avertissement - Risque d'explosion - Ne pas débrancher tant que le circuit est sous tension à moins que l'emplacement soit connu pour ne contenir aucune concentration de gaz inflammable.

Avertissement - Risque d'explosion - La substitution de tout composant peut rendre ce matériel incompatible pour une utilisation en classe I, division 2.

Class I, Division 2, Groups A, B, C, D
HAZARDOUS LOCATION

NON HAZARDOUS LOCATION

Detail: left side

USB Port for Auto Configuration Adapter.
For maintenance only.

V.24 Interface (External management)

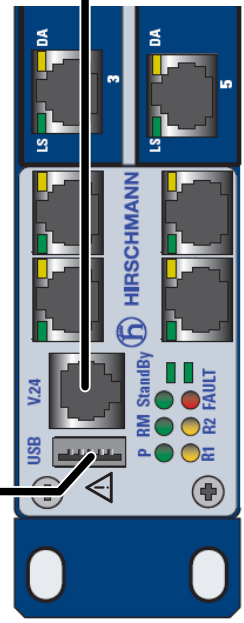

Power Supply 2

9: Not present

C: 18 V DC to 60 V DC

G: 77 V DC to 300 V DC / 90 V AC to 265 V AC

L: 18 V DC to 60 V DC

M: 77 V DC to 300 V DC / 90 V AC to 265 V AC

Relay Contacts:

Associated Apparatus:
Equipment with nonincendive field wiring

Power Supply 1

C: 18 V DC to 60 V DC

G: 77 V DC to 300 V DC / 90 V AC to 265 V AC

L: 18 V DC to 60 V DC

M: 77 V DC to 300 V DC / 90 V AC to 265 V AC

Detail: right side

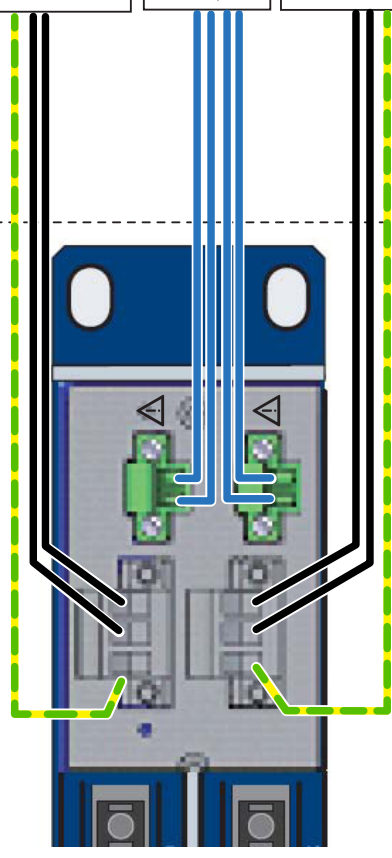

The Use in Hazardous Locations is only allowed for MACH1000-Family model No's which are individually labeled "FOR USE IN CLASS I, DIVISION 2 HAZARDOUS LOCATIONS".

CONTROL DRAWING for Ethernet Switch MACH1000	
Family	
According to ANSI / ISA 12.12.01-2011	
Rev.: 0	Date: 2012-01-10
Document No.: 000159391DNR	

 **HIRSCHMANN**
A BELDEN BRAND

Page 1 of 2

Notes:



The nonincendive field wiring circuit concept allows interconnection of nonincendive field wiring apparatus and associated nonincendive field wiring apparatus using any of the wiring methods permitted for unclassified locations when certain parametric conditions are met.

Voltage: $V_{max} \geq V_{oc}$

Capacity: $C_a \geq C_i + C_{Cable}$

The maximum cable length has to be determined as follows:

(a) max. Cable Length $< (L_a - L_i) / L_{Cable}$ and (b) max. Cable Length $< (C_a - C_i) / C_{Cable}$

The lower value of (a) and (b) is to apply.

L_{Cable} : inductance per unit length of used cable.

C_{Cable} : capacitance per unit length of used cable.

Other C-parameters and L-parameters are according to ANSI / ISA 12.12.01-2011 section 7.

Where the cable capacitance and inductance per foot are not known, the following values shall be used:

C_{Cable} 60 pF/foot, L_{Cable} 0.2 μ H/foot

Nonincendive field wiring circuits must be wired in accordance with the National Electrical Code (NEC), NFPA 70, article 501.

Current: $I_{max} \geq I_{sc}$

Inductivity: $L_a \geq L_i + L_{Cable}$

Nonincendive Field Wiring Parameters:

The Relay Contacts are dependent upon the following Entity parameters:

V_{max}	I_{max}	C_i	L_i
30 V	90 mA	50 pF	2 μ H



WARNING – EXPLOSION HAZARD – SUBSTITUTION OF ANY COMPONENTS MAY IMPAIR SUITABILITY FOR HAZARDOUS LOCATIONS OR EXPLOSIVE ATMOSPHERES.

WARNING – EXPLOSION HAZARD – DO NOT DISCONNECT EQUIPMENT UNLESS POWER HAS BEEN SWITCHED OFF OR THE AREA IS KNOWN TO BE NON-HAZARDOUS.

DO NOT OPEN WHEN ENERGIZED.

CONTROL DRAWING for Ethernet Switch MACH1000

Family

According to ANSI / ISA 12.12.01-2011



HIRSCHMANN
A BELDEN BRAND

Rev.: 0

Date: 2012-01-10

Document No.: 000159391DNR

Page 2 of 2

■ **CE marking**

The labeled devices comply with the regulations contained in the following European directive(s):

2011/65/EU (RoHS)

Directive of the European Parliament and of the Council on the restriction of the use of certain hazardous substances in electrical and electronic equipment.

2004/108/EC (EMC)

Directive of the European Parliament and the council for standardizing the regulations of member states with regard to electromagnetic compatibility.

2006/95/EC

Directive of the European Parliament and the council for standardizing the regulations of member states with regard to electrical equipment to be used within specific voltage ranges.

In accordance with the above-named EU directive(s), the EU conformity declaration will be at the disposal of the relevant authorities at the following address:

Hirschmann Automation and Control GmbH

Stuttgarter Str. 45-51

72654 Neckartenzlingen

Germany

Tel.: +49 1805 141538

The product can be used in the industrial sector.

▶ Interference immunity: EN 61000-6-2

▶ Emitted interference: EN 55022

▶ Reliability: EN 60950-1

You find more information on technical standards here:

[“Technical data” on page 52](#)

The assembly guidelines provided in these instructions must be strictly adhered to in order to observe the EMC threshold values.

Warning! This is a class A device. This device can cause interference in living areas, and in this case the operator may be required to take appropriate measures.

■ **LED or laser components**

LED or LASER components according to IEC 60825-1 (2014):

CLASS 1 LASER PRODUCT

CLASS 1 LED PRODUCT

■ **FCC note:**

This device complies with part 15 of the FCC rules. Operation is subject to the following two conditions: (1) this device may not cause harmful interference; (2) this device must accept any interference received, including interference that may cause undesired operation.

Appropriate testing has established that this device fulfills the requirements of a class A digital device in line with part 15 of the FCC regulations.

These requirements are designed to provide sufficient protection against interference when the device is being used in a business environment.

The device creates and uses high frequencies and can also radiate these frequencies. If it is not installed and used in accordance with this operating manual, it can cause radio transmission interference. The use of this device in a residential area can also cause interference, and in this case the user is obliged to cover the costs of removing the interference.

■ **Recycling note**

After usage, this device must be disposed of properly as electronic waste, in accordance with the current disposal regulations of your county, state, and country.

About this Manual

The “Installation” user manual contains a device description, safety instructions, a description of the display, and the other information that you need to install the device.

The following manuals are available as PDF files on the CD/DVD supplied:

- ▶ Installation user manual
- ▶ Basic Configuration user manual
- ▶ Redundancy Configuration user manual
- ▶ Reference manual for the graphical user interface
- ▶ Command Line Interface reference manual

The Industrial HiVision network management software provides you with additional options for smooth configuration and monitoring:

- ▶ ActiveX control for SCADA integration
- ▶ Auto-topology discovery
- ▶ Browser interface
- ▶ Client/server structure
- ▶ Event handling
- ▶ Event log
- ▶ Simultaneous configuration of multiple devices
- ▶ Graphical user interface with network layout
- ▶ SNMP/OPC gateway

Legend

The symbols used in this manual have the following meanings:

▶	Listing
□	Work step
■	Subheading

1 Description

1.1 General device description

You can choose from between a wide range of variants. You have the option to set up your device individually based on different criteria:

- ▶ Number of ports
- ▶ Transmission speed
- ▶ Types of connectors
- ▶ Temperature range
- ▶ Supply voltage range
- ▶ Certifications

The MACH 1000 devices are designed for the special requirements of industrial automation. They meet the relevant industry standards, provide very high operational reliability, even under extreme conditions, and also long-term reliability and flexibility.

The devices allow you to set up switched industrial Ethernet networks that conform to the IEEE 802.3 standard.

The devices work without a fan.

If required, the devices are PoE-capable.

For devices without PoE, the voltage supply can be redundant if required.

The following installation options are available:

- ▶ 19" switch cabinet
- ▶ Mounting on a flat surface

You have the option of choosing various media to connect to the terminal devices and other network components:

- ▶ twisted pair cable
- ▶ multimode F/O
- ▶ singlemode F/O

The ring redundancy concept allows the network to be reconfigured quickly after a failure.

Product configuration data can be provided by:

- ▶ diagnosis displays
- ▶ displaying the operating parameters

There are convenient options for managing the device. Administer your devices via:

- ▶ a Web browser
- ▶ Telnet

- ▶ HiDiscovery (Software for putting the device into operation)
- ▶ network management software (e.g. Industrial HiVision)
- ▶ a V.24 interface (locally on the device)

The devices provide you with a large range of functions, which the manuals for the operating software inform you about. You will find these manuals as PDF files on the enclosed CD/DVD, or you can download them from the Internet on the Hirschmann product pages (www.hirschmann.com). The Hirschmann network components help you ensure continuous communication across all levels of the company.

1.2 Combination options

The product designation of your device is made from combining the desired product characteristics in accordance with the following table. The corresponding short designation is in column 3.

You have numerous options of combining the device characteristics. You can determine the possible combinations using the configurator which is available in the Belden E-Catalog (www.e-catalog.beldensolutions.com) on the web page of the device.

Position	Characteristic	Ident.	Property
1 to 7	Product	MAR1020	MACH Ruggedized Fast Ethernet Switch
		MAR1030	MACH Ruggedized Gigabit Ethernet Switch
		MAR1022	MACH Ruggedized Fast Ethernet Switch with PoE ^{a b}
		MAR1032	MACH Ruggedized Gigabit Ethernet Switch with PoE ^{a b}
		MAR1120	MACH Ruggedized Fast Ethernet Switch, ports on the back
		MAR1130	MACH Ruggedized Gigabit Ethernet Switch, ports on the back
		MAR1122	MACH Ruggedized Fast Ethernet Switch, ports on the back and with PoE ^{a b}
		MAR1132	MACH Ruggedized Gigabit Ethernet Switch, ports on the back and with PoE ^{a b}
8	- (hyphen)	-	
9 to 10	10/100/1000 Mbit/s ports 1 + 2 or 1 to 4	99	Not present (in MAR1020)
		CC	2 × combo port (SFP slot: 100/1000 Mbit/s, alternatively twisted pair RJ45 socket: 10/100/1000 Mbit/s)
		4O	2 × 2 Gigabit Ethernet ports SFP 1000 Mbit/s
		4T	2 × 2 Gigabit Ethernet ports RJ45 10/100/1000 Mbit/s
		OT	2 × Gigabit Ethernet port SFP 1000 Mbit/s plus 2 × Gigabit Ethernet port RJ45 10/100/1000 Mbit/s
11 to 12	10/100 Mbit/s ports 1+ 2 ^a)	99	Module position empty
		TT	2 × twisted pair TX, RJ45, 10/100 Mbit/s
		BB	2 × Multimode FX LC 100 Mbit/s
		MM	2 × Multimode FX DSC 100 Mbit/s
		JJ	2 × Multimode FX MTRJ 100 Mbit/s
		NN	2 × Multimode FX ST 100 Mbit/s
		VV	2 × Singlemode FX DSC 100 Mbit/s
		UU	2 × Singlemode FX ST 100 Mbit/s
		LL	2 × Singlemode Long Haul FX DSC 100 Mbit/s
		GG	2 × Singlemode Long Haul FX DSC 200 km 100 Mbit/s
		ZZ	2 × SFP slot 100 Mbit/s
RR	2 × twisted pair TX, M12, 10/100 Mbit/s		
FF ^b	2 × Multimode FL ST 10 Mbit/s		

Table 1: Combination options for the device variants of the MACH 1000

Position	Characteristic	Ident.	Property
13 to 14	10/100 Mbit/s ports 3 + 4		See 11 to 12
15 to 16	10/100 Mbit/s ports 5 + 6		See 11 to 12
17 to 18	10/100 Mbit/s ports 7 + 8		See 11 to 12
19 to 20	10/100 Mbit/s ports 9 + 10		See 11 to 12
21 to 22	10/100 Mbit/s ports 11 + 12		See 11 to 12
23 to 24	10/100 Mbit/s ports 13 + 14		See 11 to 12
25 to 26	10/100 Mbit/s ports 15 + 16		See 11 to 12
27 to 28	10/100 Mbit/s ports 17 + 18		See 11 to 12
29 to 30	10/100 Mbit/s ports 19 + 20		See 11 to 12
31 to 32	10/100 Mbit/s ports 21 + 22		See 11 to 12
33 to 34	10/100 Mbit/s ports 23 + 24		See 11 to 12
35	Temperature range	S	Standard: see page 52
		U	Extended: see page 52
		F	Extended, Conformal Coating: see page 52
36	Type of power supply unit 1	C	Specification of types: see page 52
		G	
		L	
		M	
37	Type of power supply unit 2	9	Not present
		C	Specification of types: see page 52
		G	
		L	
38	Approvals	H	CE, UL 508, ISA 12.12.01- Class I, Div. 2, GL, IEC 61850, IEEE 1613 Substation, EN 50121-4 Railway (along track), NEMA TS2
		T	CE, UL 508, ISA 12.12.01- Class I, Div. 2, EN 50121-4 railway (along track), NEMA TS2, EN 50155 railway (train) ^{cd}
39	Software variant	P	Professional

Table 1: Combination options for the device variants of the MACH 1000

- In device variants with PoE (Power over Ethernet), the first 4 ports can be twisted pair TX RJ45 10/100 Mbit/s (short designation TT) or twisted pair TX M12 10/100 Mbit/s (short designation RR), as desired. The other ports are freely selectable from the table. Power supply unit 2 is a PoE power supply unit (input voltage range position 37: “G” or “M”). Power supply unit 1 is freely selectable from the table.
- Device variants with PoE or with FL ports: no “T” certification (EN 50155 railway (train)) present.
- Rated voltage for power supply unit type G and M: 110 VDC; for power supply unit type C and L: 36 VDC
- The railway standard EN 50155 is only met if the PoE power is limited to 15 W.

1.3 Description of the device variants

- ▶ The MAR1020-..., MAR1022-..., MAR1120-... and MAR1122-... device variants are MACH 1000 Ruggedized Switches without Gigabit ports and, depending on the requirements, a selectable number (up to 24) of Fast Ethernet ports (10/100 Mbit/s). You can choose the media for the Fast Ethernet ports 1 to 24 in pairs.
The MAR1120-... and MAR1122-... devices have an additional Fast Ethernet port on the front of the device that you can use for diagnosis purposes.
 - ▶ The MAR1022-... devices support PoE in accordance with IEEE 802.3af.
The PoE ports are the Fast Ethernet ports 1 to 4.
 - ▶ In the MAR1120-... devices, all the cable outlets are at the back, i.e. the ports are on the back of the device.
 - ▶ The MAR1122-... devices support PoE in accordance with IEEE 802.3af.
The PoE ports are the Fast Ethernet ports 1 to 4.
All the cable outlets are at the back, i.e. the ports are on the back of the device.

- ▶ The MAR1030-..., MAR1032-..., MAR1130-... and MAR1132-... device variants are MACH 1000 Ruggedized Switches with 2 or 4 Gigabit ports (10/100/1000 Mbit/s) and, depending on the requirements, a selectable number (up to 24) of Fast Ethernet ports (10/100 Mbit/s). You can choose the media for the Fast Ethernet ports 1 to 24 in pairs.
In device variants with 2 Gigabit Ethernet ports, these ports are combo ports (2 x SFP slot: 100/1000 Mbit/s, alternatively:
2 x twisted pair RJ45 socket: 10/100/1000 Mbit/s).
In device variants with 4 Gigabit Ethernet ports, these can be optionally -
SFP slots (2 x 2 slots),
- twisted pair RJ45 sockets (2 x 2 sockets) or
- 2 x SFP slots plus 2 x twisted pair RJ45 sockets.
The MAR1130-... and MAR1132-... devices have an additional Fast Ethernet port on the front of the device that you can use for diagnosis purposes.
 - ▶ The MAR1032-... devices support PoE (Power over Ethernet) in accordance with IEEE 802.3af. The PoE ports are the Fast Ethernet ports 1 to 4.
 - ▶ In the MAR1130-... devices, all the cable outlets are at the back, i.e. the ports are on the back of the device.
 - ▶ The MAR1132-... devices support PoE (Power over Ethernet) in accordance with IEEE 802.3af. The PoE ports are the Fast Ethernet ports 1 to 4.
In these devices, all the cable outlets are at the back, i.e. the ports are on the back of the device.

1.3.1 Front view of the MACH 1000 with 2 Gigabit ports

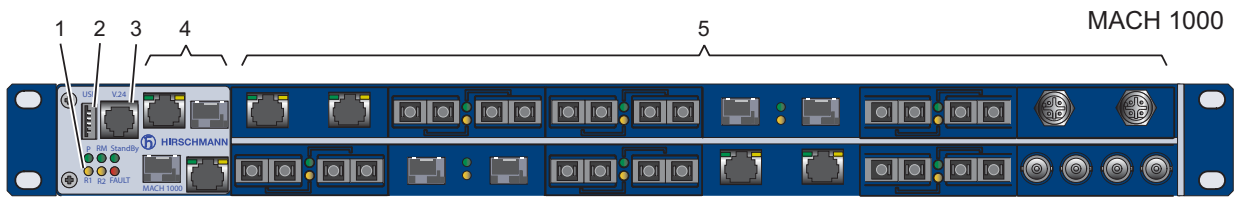

Figure 1: 1 - LED display elements
 2 - USB interface
 3 - V.24 connection for external management
 4 - See following table, column 1
 5 - See following table, column 2

Gigabit Ethernet GE ports 1 and 2 (combo ports)	Fast Ethernet FE ports 1 to 24, free choice of connections
100/1000 Mbit/s	99: Module position empty
Fiber optic, SFP slots	TT: 2 * twisted pair TX, RJ45, 10/100 Mbit/s
Alternative connections: 10/100/1000 Mbit/s	MM: 2 * Multimode FX DSC 100 Mbit/s
Twisted pair, RJ45 connections	JJ: 2 * Multimode FX MTRJ 100 Mbit/s
	NN: 2 * Multimode FX ST 100 Mbit/s
	VV: 2 * Singlemode FX DSC 100 Mbit/s
	UU: 2 * Singlemode FX ST 100 Mbit/s
	LL: 2 * Singlemode Long Haul FX DSC 100 Mbit/s
	GG: 2 * Singlemode Long Haul FX DSC 200 km 100 Mbit/s
	ZZ: 2 * SFP slot 100 Mbit/s
	RR: 2 * twisted pair TX, M12, 10/100 Mbit/s
	FF: 2 * Multimode FL ST 10 Mbit/s

1.3.2 Front view of the MACH 1000 with 4 Gigabit ports (SFP)

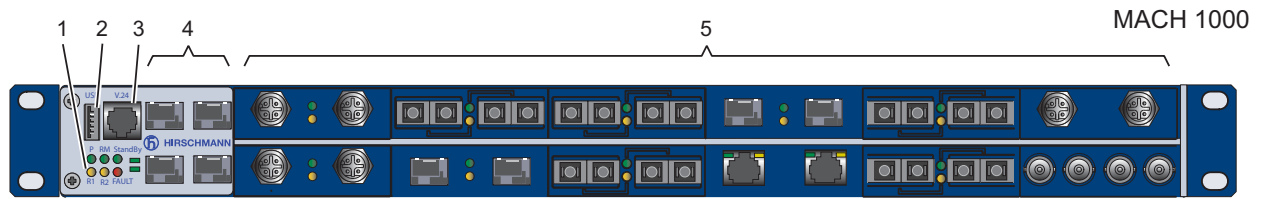

Figure 2: 1 - LED display elements
 2 - USB interface
 3 - V.24 connection for external management
 4 - See following table, column 1
 5 - See following table, column 2

Gigabit Ethernet GE ports 1 to 4	Fast Ethernet FE ports 1 to 24, free choice of connections
1000 Mbit/s	99: Module position empty
Fiber optic, SFP slots	TT: 2 * twisted pair TX, RJ45, 10/100 Mbit/s
	MM: 2 * Multimode FX DSC 100 Mbit/s
	JJ: 2 * Multimode FX MTRJ 100 Mbit/s
	NN: 2 * Multimode FX ST 100 Mbit/s
	VV: 2 * Singlemode FX DSC 100 Mbit/s
	UU: 2 * Singlemode FX ST 100 Mbit/s
	LL: 2 * Singlemode Long Haul FX DSC 100 Mbit/s
	GG: 2 * Singlemode Long Haul FX DSC 200 km 100 Mbit/s
	ZZ: 2 * SFP slot 100 Mbit/s
	RR: 2 * twisted pair TX, M12, 10/100 Mbit/s
	FF: 2 * Multimode FL ST 10 Mbit/s

1.3.3 Front view of the MACH 1000 with 4 Gigabit ports (2 x SFP and 2 x RJ45)

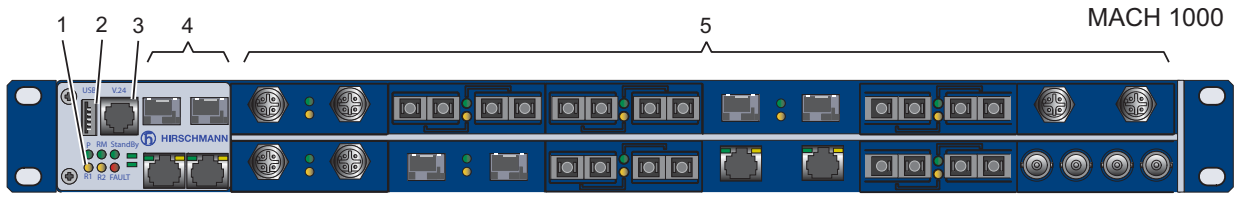

Figure 3: 1 - LED display elements
 2 - USB interface
 3 - V.24 connection for external management
 4 - See following table, column 1
 5 - See following table, column 2

Gigabit Ethernet GE ports 1 to 4	Fast Ethernet FE ports 1 to 24, free choice of connections
1000 Mbit/s	99: Module position empty
Fiber optic, SFP slots	TT: 2 * twisted pair TX, RJ45, 10/100 Mbit/s
And / or:	MM: 2 * Multimode FX DSC 100 Mbit/s
10/100/1000 Mbit/s	JJ: 2 * Multimode FX MTRJ 100 Mbit/s
Twisted pair, RJ45 connections	NN: 2 * Multimode FX ST 100 Mbit/s
	VV: 2 * Singlemode FX DSC 100 Mbit/s
	UU: 2 * Singlemode FX ST 100 Mbit/s
	LL: 2 * Singlemode Long Haul FX DSC 100 Mbit/s
	GG: 2 * Singlemode Long Haul FX DSC 200 km 100 Mbit/s
	ZZ: 2 * SFP slot 100 Mbit/s
	RR: 2 * twisted pair TX, M12, 10/100 Mbit/s
	FF: 2 * Multimode FL ST 10 Mbit/s

1.3.4 Front view of the MACH 1000 with PoE

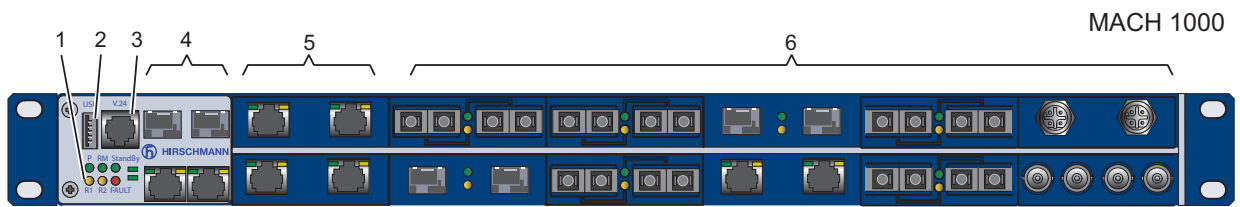

Figure 4: 1 - LED display elements
 2 - USB interface
 3 - V.24 connection for external management
 4 - See below [table 2](#), column 1
 5 - See below [table 2](#), column 2
 6 - See below [table 3](#)

Gigabit Ethernet Up to 4 GE ports	Fast Ethernet FE ports 1 to 4, Power over Ethernet
1000 Mbit/s	TT: 2 * twisted pair TX, RJ45, 10/100 Mbit/s
Fiber optic, SFP slots	RR: 2 * twisted pair TX, M12, 10/100 Mbit/s
And / or:	
10/100/1000 Mbit/s	
Twisted pair, RJ45 connections	



Table 2: Gigabit Ethernet, Fast Ethernet FE ports 1 to 4

Fast Ethernet FE ports 5 to 24, free choice of connections
99: Module position empty
TT: 2 * twisted pair TX, RJ45, 10/100 Mbit/s
MM: 2 * Multimode FX DSC 100 Mbit/s
JJ: 2 * Multimode FX MTRJ 100 Mbit/s
NN: 2 * Multimode FX ST 100 Mbit/s
VV: 2 * Singlemode FX DSC 100 Mbit/s
UU: 2 * Singlemode FX ST 100 Mbit/s
LL: 2 * Singlemode Long Haul FX DSC 100 Mbit/s
GG: 2 * Singlemode Long Haul FX DSC 200 km 100 Mbit/s
ZZ: 2 * SFP slot 100 Mbit/s
RR: 2 * twisted pair TX, M12, 10/100 Mbit/s
FF: 2 * Multimode FL ST 10 Mbit/s

Table 3: Fast Ethernet, FE ports 5 to 24

1.3.5 Views of the MACH 1000, ports in the back

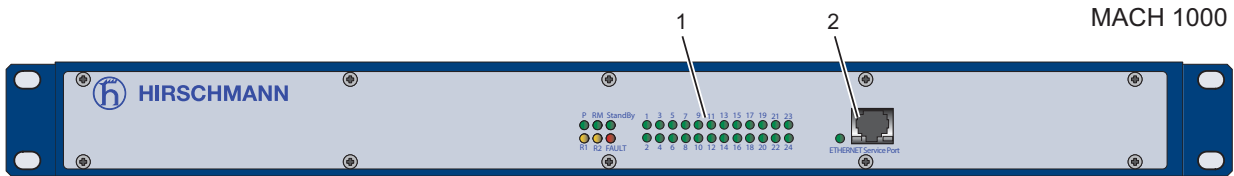

Figure 5: Front panel:
 1 - LED display elements
 2 - Diagnosis port

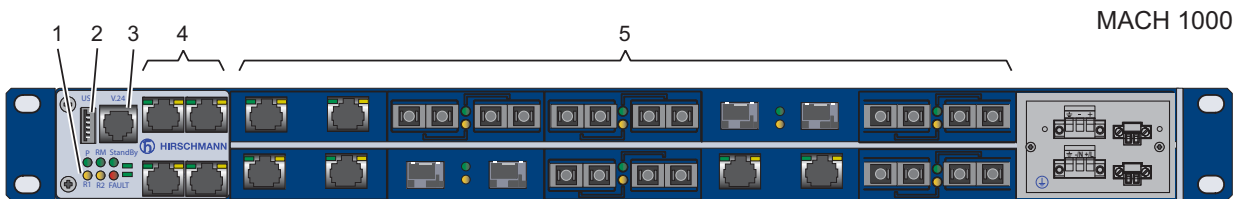

Figure 6: Rear panel:
 1 - LED display elements
 2 - USB interface
 3 - V.24 connection for external management
 4 - See following table, column 1
 5 - See following table, column 2

Gigabit Ethernet Up to 4 GE ports	Fast Ethernet FE ports 1 to 20, free choice of connections
1000 Mbit/s	99: Module position empty
Fiber optic, SFP slots	TT: 2 * twisted pair TX, RJ45, 10/100 Mbit/s
And / or:	MM: 2 * Multimode FX DSC 100 Mbit/s
10/100/1000 Mbit/s	JJ: 2 * Multimode FX MTRJ 100 Mbit/s
Twisted pair, RJ45 connections	NN: 2 * Multimode FX ST 100 Mbit/s
	VV: 2 * Singlemode FX DSC 100 Mbit/s
	UU: 2 * Singlemode FX ST 100 Mbit/s
	LL: 2 * Singlemode Long Haul FX DSC 100 Mbit/s
	GG: 2 * Singlemode Long Haul FX DSC 200 km 100 Mbit/s
	ZZ: 2 * SFP slot 100 Mbit/s
	RR: 2 * twisted pair TX, M12, 10/100 Mbit/s
	FF: 2 * Multimode FL ST 10 Mbit/s

The device variants of the MACH 1000 with ports on the rear panel have the following characteristics:

- ▶ The display LEDs are on the front of the device. There are up to 4 LEDs for displaying the status of the Gigabit Ethernet ports and up to 21 LEDs for displaying the status of the Fast Ethernet ports, as well as 6 LEDs for displaying the device status.
- ▶ The supply voltage connection and the ports are on the back of the device. The device allows you to connect a maximum of 20 Fast Ethernet ports as well as an additional Fast Ethernet port on the front of the device that you can use for diagnosis purposes.

1.3.6 Connections for voltage-carrying lines

The supply voltage is electrically isolated from the housing.

A device has one or two internal power supply units. Each power supply unit has a connection for the supply voltage and a connection for the signal contact.

The power supply unit types have the following different properties:

- ▶ Type of connections: terminal or plugged
- ▶ Type of connectable supply voltages: DC or AC voltage
- ▶ Level of connectable supply voltages:

For devices without PoE featuring 2 power supply units, you can connect the supply voltage redundantly. Both inputs are uncoupled. With a non-redundant supply of the supply voltage, the device reports the loss of a supply voltage. You can prevent this message by applying the supply voltage via both inputs, or by changing the configuration in the Management.

Note: To find out which power supply unit type your device has, refer to positions 36 and 37 of the product code (see [table 1](#) on [page 17](#)).

The following tables provide an overview of the possible connections for voltage-carrying lines:

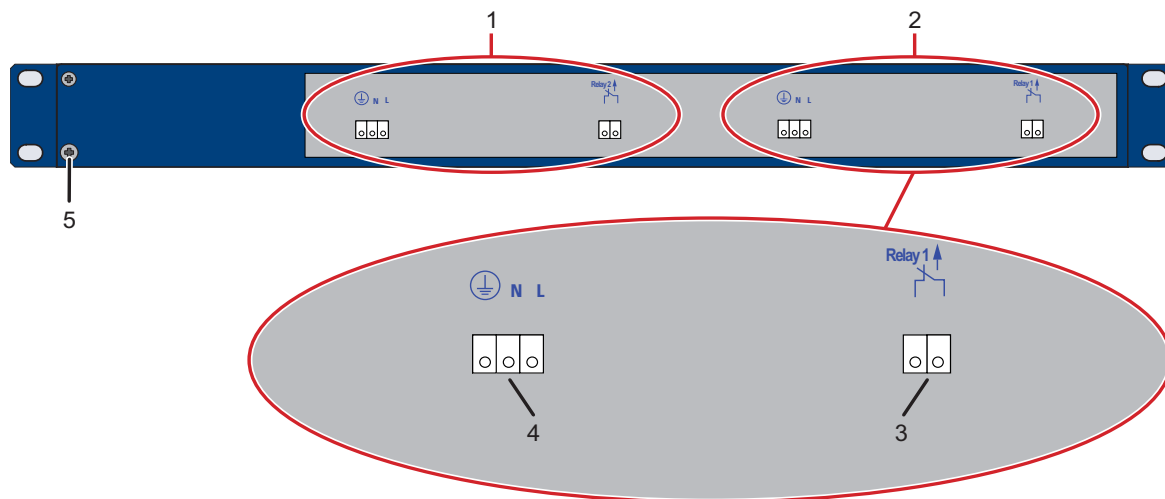

1	Power supply unit 2 ^a	Possible types:	C	DC voltage connectable
				Voltage range: See “General technical data” on page 52.
			G ^b	DC or AC voltage connectable
				Voltage range: See “General technical data” on page 52.
2	Power supply unit 1	Possible types:	C	See 1
			G	See 1
3	Connection for the signal contact	▶ Spring-loaded terminal ▶ 2-pin		
4	Supply voltage connection	▶ Spring-loaded terminal ▶ 3-pin		
5	Grounding screw			

Table 4: Connections for voltage-carrying lines:
rear view of the device variants with terminal connections

- a. In devices without PoE, power supply unit 2 is optional. It is used for redundant voltage supply. In devices with PoE, power supply unit 2 is mandatory. It is only used to supply PoE voltage to the connected devices.
- b. For devices with PoE that have terminal connections, power supply unit 2 must be type “G”.

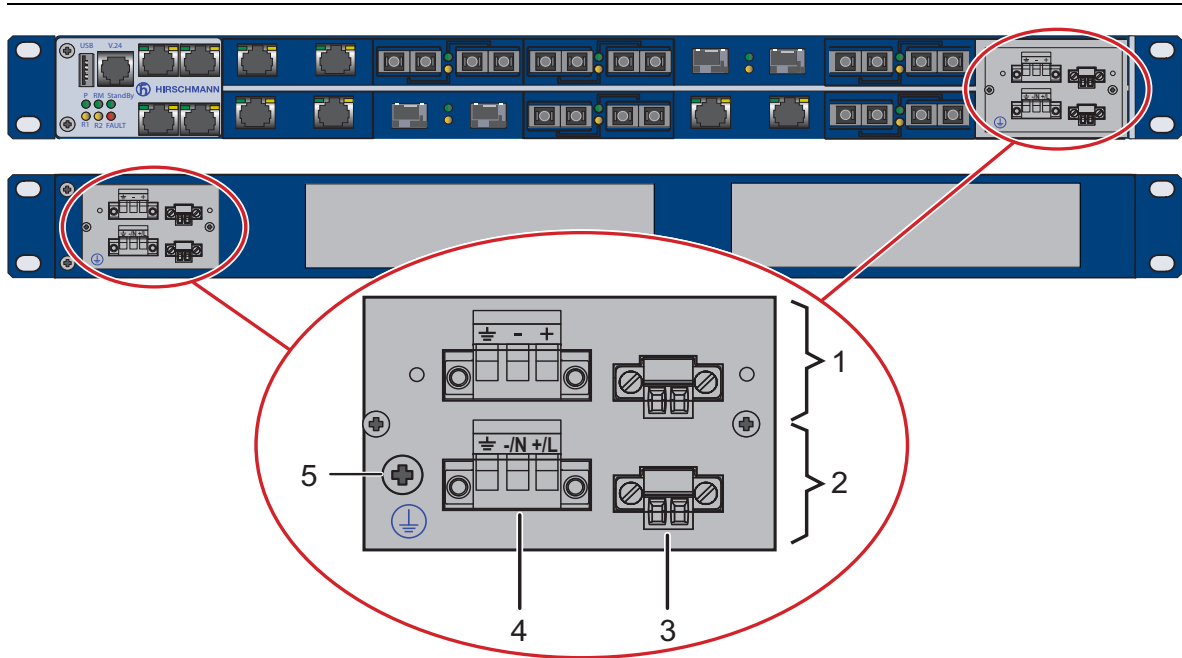

1	Power supply unit 2 ^a	Possible types:	L	DC voltage connectable Voltage range: See "General technical data" on page 52.
			M ^b	DC or AC voltage connectable Voltage range: See "General technical data" on page 52.
2	Power supply unit 1	Possible types:	L	See 1
			M	See 1
3	Connection for the signal contact	▶ Spring-loaded terminal ▶ 2-pin		
4	Supply voltage connection	▶ Spring-loaded terminal ▶ 3-pin		
5	Grounding screw			

Table 5: Connections for voltage-carrying lines:
rear view of the device variants with plugged connections (above: MAR11..., below: MAR10...)

- In devices without PoE, power supply unit 2 is optional. It is used for redundant voltage supply. In devices with PoE, power supply unit 2 is mandatory. It is only used to supply PoE voltage to the connected devices.
- For devices with PoE that have plugged connections, power supply unit 2 must be type "M".

1.3.7 MACH 1000 devices with PoE

The MACH 1000 device variants MAR1022-..., MAR1032-..., MAR1132-... and MAR 1132-... support Power over Ethernet (PoE) in accordance with IEEE 802.3af. They allow the connection and remote supply of, for example, IP telephones (Voice over IP), webcams, sensors, printer servers and WLAN access points via 10BASE-T/100BASE-TX. With PoE, these terminal devices are powered by the twisted-pair cable.

The MACH 1000 devices with PoE have 2*2 twisted pair ports TX 10/100 Mbit/s, depending on the device variant, as RJ45 or M12 sockets for connecting network segments or PoE terminal devices (PD, Powered Device) for all IEEE802.3af classes up to a maximum power output of 15.4 W.

The current is supplied on wire pairs transmitting the signal; the individual ports are not electrically insulated from each other.

The following conditions are met in accordance with IEEE 802.3af:

- ▶ Endpoint PSE
- ▶ Alternative A

1.4 Ethernet ports

You can connect end devices and other segments to the device ports using twisted pair cables or optical fibers (F/O).

You find information on pin assignments for making patch cables here:

[“Pin assignments” on page 31](#)

1.4.1 10/100/1000 Mbit/s twisted pair port

This port is an RJ45 socket.

The 10/100/1000 Mbit/s twisted pair port offers you the ability to connect network components according to the IEEE 802.3 10BASE-T/100BASE-TX/1000BASE-T standard.

This port supports:

- ▶ Autonegotiation
- ▶ Autopolarity
- ▶ Autocrossing (if autonegotiation is activated)
- ▶ 1000 Mbit/s full duplex
- ▶ 100 Mbit/s half-duplex mode, 100 Mbit/s full duplex mode
- ▶ 10 Mbit/s half-duplex mode, 10 Mbit/s full duplex mode

Delivery state: Autonegotiation activated

The socket housing is electrically connected with the front panel.

The pin assignment corresponds to MDI-X.

1.4.2 10/100 Mbit/s twisted pair port

This port is an RJ45 socket.

The 10/100 Mbit/s twisted pair port offers you the ability to connect network components according to the IEEE 802.3 10BASE-T/100BASE-TX standard.

This port supports:

- ▶ Autonegotiation
- ▶ Autopolarity
- ▶ Autocrossing (if autonegotiation is activated)
- ▶ 100 Mbit/s half-duplex mode, 100 Mbit/s full duplex mode
- ▶ 10 Mbit/s half-duplex mode, 10 Mbit/s full duplex mode

Delivery state: Autonegotiation activated

The socket housing is electrically connected with the front panel.

Pin assignment of the RJ45 socket:

- One line pair: pin 3 and pin 6
- One line pair: pin 1 and pin 2
- Remaining pins: not used.

Note: In substation applications, the RJ45 ports are used to connect to additional communication devices such as routers or telecommunication multiplexers that are installed in close proximity to the device (i.e. less than 3 meters away). It is not recommended to use these ports for connection to field devices across longer distances which could cause a significant increase in the ground potential (Ground Potential Rise GPR, i.e. more than 2500 V).

1.4.3 10/100 Mbit/s PoE port

This port is an RJ45 socket or a M12 socket.

The 10/100 Mbit/s PoE port allows you to connect network components as a PoE voltage sink according to the standard IEEE 802.3 10BASE-T/100BASE-TX and IEEE 802.3af.

This port supports:

- ▶ Autonegotiation
- ▶ Autopolarity
- ▶ Autocrossing (if autonegotiation is activated)
- ▶ 100 Mbit/s half-duplex mode, 100 Mbit/s full duplex mode
- ▶ 10 Mbit/s half-duplex mode, 10 Mbit/s full duplex mode
- ▶ Power over Ethernet (PoE)

Delivery state: Autonegotiation activated

The socket housing is electrically connected with the front panel.

The PoE power is supplied via the wire pairs transmitting the signal (phantom voltage).

- Use a shielded CAT5 cable or better.
- Use a shielded 4-pin M12 plug.
- Connect the cable shield to the connector housing.

1.4.4 1000 Mbit/s F/O port

This port is an SFP slot.

The 1000 Mbit/s F/O port offers you the ability to connect network components according to the IEEE 802.3 100BASE-SX/1000BASE-LX standard.

This port supports:

- ▶ Autonegotiation

Delivery state: Autonegotiation activated.

Note: On the MACH 1030 with two 1000 Mbit/s F/O ports, these ports are combo ports (SFP/RJ45). You can use either the SFP slot or the RJ45 socket to connect data cables. If both are used, the assigned SFP slot switches off the related RJ45 port.

1.4.5 100 Mbit/s F/O port

This port is an ST, LC, DSC or MTRJ socket or an SFP slot.

The 100 Mbit/s F/O port offers you the ability to connect network components according to the IEEE 802.3 100BASE-FX standard.

This port supports:

- ▶ Full or half duplex mode

Default setting: Full duplex

1.4.6 10 Mbit/s F/O port

This port is an ST socket.

The 10 Mbit/s F/O port offers you the ability to connect network components according to the IEEE 802.3 10BASE-FL standard.

This port supports:

- ▶ Full or half duplex mode

Default setting: Full duplex

1.4.7 Pin assignments

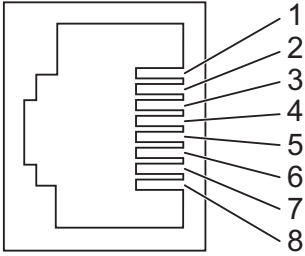
RJ45	Pin	10/100 Mbit/s	1000 Mbit/s	PoE
	MDI mode			
	1	TX+	BI_DA+	Positive V_{PSE}^a
	2	TX-	BI_DA-	Positive V_{PSE}^a
	3	RX+	BI_DB+	Negative V_{PSE}^a
	4	—	BI_DC+	Positive V_{PSE}^b
	5	—	BI_DC-	Positive V_{PSE}^b
	6	RX-	BI_DB-	Negative V_{PSE}^a
	7	—	BI_DD+	Negative V_{PSE}^b
	8	—	BI_DD-	Negative V_{PSE}^b
	MDI-X mode			
	1	RX+	BI_DB+	Negative V_{PSE}^a
	2	RX-	BI_DB-	Negative V_{PSE}^a
	3	TX+	BI_DA+	Positive V_{PSE}^a
	4	—	BI_DD+	Positive V_{PSE}^b
	5	—	BI_DD-	Positive V_{PSE}^b
	6	TX-	BI_DA-	Positive V_{PSE}^a
7	—	BI_DC+	Negative V_{PSE}^b	
8	—	BI_DC-	Negative V_{PSE}^b	

- a. Phantom supply
b. Spare pair supply

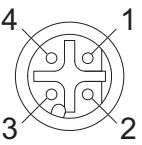
M12 4-pin (D coded)	Pin	Data	PoE
	1	TX+	Positive V_{PSE}
	2	RX+	Negative V_{PSE}
	3	TX-	Positive V_{PSE}
	4	RX-	Negative V_{PSE}

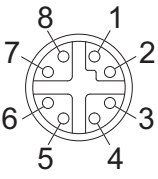
M12 8-pin (X-coded)	Pin	10/100 Mbit/s	1000 Mbit/s	PoE
	1	RX+	BI_DB+	Negative V_{PSE}
	2	RX-	BI_DB-	Negative V_{PSE}
	3	TX+	BI_DA+	Positive V_{PSE}
	4	TX-	BI_DA-	Positive V_{PSE}
	5	—	BI_DC+	—
	6	—	BI_DC-	—
	7	—	BI_DD-	—
	8	—	BI_DD+	—

1.5 Display elements

After the supply voltage is set up, the software starts and initializes itself. Afterwards, the device performs a self-test. During this process, various LEDs light up. The process takes around 60 seconds.

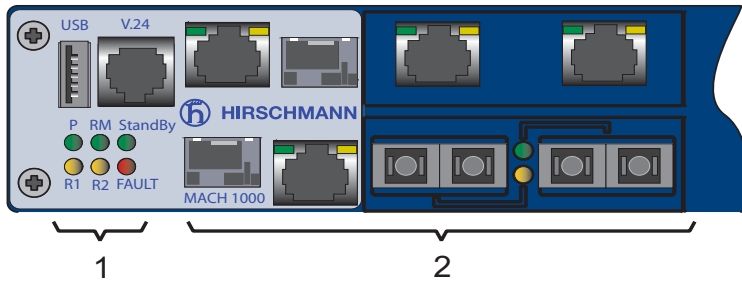

Figure 7: Display elements of MACH 1000, device variants with ports on the front
 1 - Device status display elements
 2 - Port status display elements

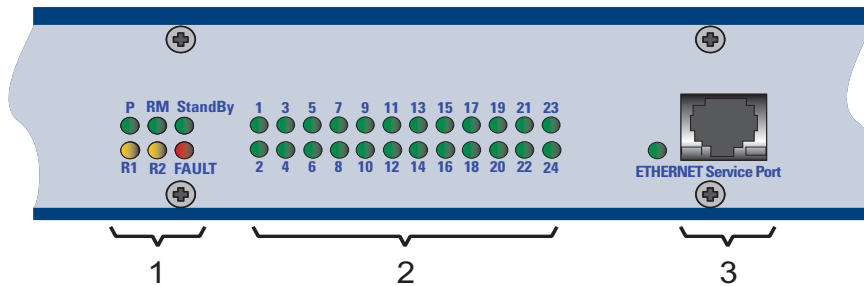

Figure 8: Display elements of MACH 1000, device variants with ports on the back
 1 - Device status display elements
 2 - Port status display elements for up to 4 Gigabit Ethernet ports and up to 20 Fast Ethernet ports
 3 - Diagnosis port with display element

1.5.1 Device state

These LEDs provide information about conditions which affect the operation of the whole device.

The following table applies only to device variants with 2 power supply units:

LED	Display	Color	Activity	Meaning
P	Supply voltage	Green	Lights up	Supply voltages 1 and 2 are on
		Yellow	Lights up	Supply voltage 1 or 2 is on
		None		The supply voltages 1 and 2 are too low.

The following table applies only to device variants with one power supply unit:

LED	Display	Color	Activity	Meaning
P	Supply voltage	Green	Lights up	Supply voltage is on
		None		Supply voltage is too low

The following table applies to all device variants:

LED	Display	Color	Activity	Meaning
Stand-by	Stand-by mode		None	Stand-by mode not enabled
		Green	Lights up	Standby mode enabled
RM	Ring Manager		None	The RM function is deactivated.
		Green	Lights up	The RM function is active. The redundant port is disabled.
			flashing	The device detects an incorrect configuration of the HIPER-Ring (e.g. the ring is not connected to the ring port).
		Yellow	Lights up	The RM function is active. The redundant port is enabled.
RM and Stand-by	ACA memory operations		Flashing alternately	Error in the memory operation
			flash synchronously – 2 x per period	Save a configuration file from the ACA to the device.
			flash synchronously – 1 x per period	Saving a configuration file from the device to the ACA.

Applies to software releases previous to 06.0.00:

LED	Display	Color	Activity	Meaning
FAULT	Signal contact 1	Red	Lights up	The signal contact is open - it is reporting a detected error.
			None	The signal contact is closed - it is not reporting any detected errors.

Applies to software release 06.0.00 and higher:

LED	Display	Color	Activity	Meaning
FAULT	Signal contact 1	Red	Lights up	The signal contact is open - it is reporting a detected error.
			None	The signal contact is closed - it is not reporting any detected errors.
	Duplicate IP detection	Red	flashes 4 times a period	Reports an IP conflict.

Applies to software releases previous to 06.0.00:

LED	Display	Color	Activity	Meaning
R1	Signal contact 1	Yellow	Lights up	The signal contact is closed in manual operation.
			None	The signal contact is open in manual operation.
R2	Signal contact 2	Yellow	Lights up	The signal contact is closed in manual operation.
			None	The signal contact is open in manual operation.

Applies to software release 06.0.00 and higher:

LED	Display	Color	Activity	Meaning
R1	Signal contact 1	Yellow	Lights up	The signal contact is open.
			None	The signal contact is closed.
R2	Signal contact 2	Yellow	Lights up	The signal contact is open.
			None	The signal contact is closed.

If the manual setting is active on the signal contact, then the error display is independent of the setting of the signal contact.

1.5.2 Port state

The green and yellow LEDs at the individual port display port-related information. During the boot phase, these LEDs are used to display the status of the boot procedure.

LS - data, link status (one green/yellow LED or one green and one yellow LED)	
Not glowing	No valid connection.
Glowing green	Valid connection.
Flashing green (1 time a period)	Port is switched to stand-by.
Flashing green (3 times a period)	Port is switched off.
Flashing yellow	Data reception.

1.6 Management interfaces

1.6.1 V.24 interface (external management)

The V.24 interface is an RJ11 socket.

The V.24 user interface is serial and allows you to connect the following devices directly:

- ▶ External management station (VT100 terminal or PC with appropriate terminal emulation). With this management station, the Command Line Interface (CLI) is available to you. Furthermore, the system monitor is available to you at the system start.
- ▶ An AutoConfiguration Adapter ACA 11

VT 100 terminal settings

Speed	9600 Baud
Data	8 bit
Stopbit	1 bit
Handshake	off
Parity	none

The socket housing is electrically connected to the front panel of the device. The V.24 interface is not electrically isolated from the supply voltage.

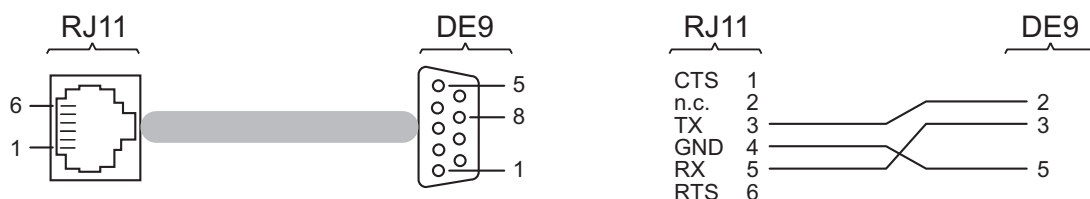

Figure 9: Pin assignment of the V.24 interface and the DE9 connector

Note: You will find the order number for the terminal cable, which is ordered separately, in the Technical Data section ([see on page 52 “Technical data”](#)).

You will find a description of the V.24 interface in the “User Manual Basic Configuration” document on the CD/DVD supplied.

1.6.2 USB interface

The USB interface allows you to connect the AutoConfiguration Adapter ACA21 storage medium. This is used for saving/loading the configuration data and diagnostic information, and for loading the software.

Figure	Pin	Operation
	1	VCC (VBus)
	2	- Data
	3	+ Data
	4	Ground (GND)

Table 6: Pin assignment of the USB interface

1.7 Signal contact

Depending on the MACH 1000 device variant (equipped with one or two power units), you have either one or two signal contacts.

- ▶ The signal contact is a potential-free relay contact.
The device allows you to perform remote diagnosis via the signal contact. In the process, the device signals events such as a line interruption. When an event occurs, the device opens the relay contact and interrupts the closed circuit. The management setting specifies which events switch a contact.
You can also use the management to switch the signal contact manually and thus control external devices.
- ▶ You can also use the Management to switch the signal contact manually and thus control external devices.

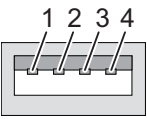
The potential-free signal contact (relay contact, closed circuit) reports through a break in contact:

- ▶ The failure of at least one supply voltage.
- ▶ The device is not operational.
- ▶ The failure of the connection on at least one port.
The report of the link status can be masked by the Management for each port. In the delivery state, is deactivated.
- ▶ Failure of the ring redundancy reserve.
- ▶ Errors detected during the self-diagnostic test.
- ▶ Incorrect configuration of the HIPER-Ring or ring coupling.
- ▶ Permitted temperature range exceeded/not reached.

The following condition is also reported in RM mode:

- ▶ Ring redundancy reserve is available. On delivery, there is no ring redundancy monitoring.

Note: You can use the signal contact functions when the voltage supply is connected. If there is redundant voltage supply, but this is turned off, there is a contact interruption at the corresponding signal contact.

2 Installation

The devices have been developed for practical application in a harsh industrial environment.

On delivery, the device is ready for operation.

Perform the following steps to install and configure the device:

- ▶ [Checking the package contents](#)
- ▶ [Connecting the power unit connections for supply voltage and signal contact](#)
- ▶ [Installing and grounding the device](#)
- ▶ [Operating the device](#)
- ▶ [Connecting data cables](#)
- ▶ [Installing an SFP transceiver \(optional\)](#)

2.1 Checking the package contents

- Check whether the package includes all items named in the section [“Scope of delivery” on page 61](#).
- Check the individual parts for transport damage.

2.2 Connecting the power unit connections for supply voltage and signal contact

2.2.1 Connecting the voltage supply terminals (power supply units “C” and “G”)

WARNING

ELECTRIC SHOCK

Connect only a supply voltage that corresponds to the type plate of your device.

Never insert sharp objects (small screwdrivers, wires, etc.) into the connection terminals for electric conductors, and do not touch the terminals.

Failure to follow these instructions can result in death, serious injury, or equipment damage.



Note: Note the permitted voltage ranges for devices with certification type “T” (EN 50155 railway (train) - see product code position 38 in [table 1](#)).

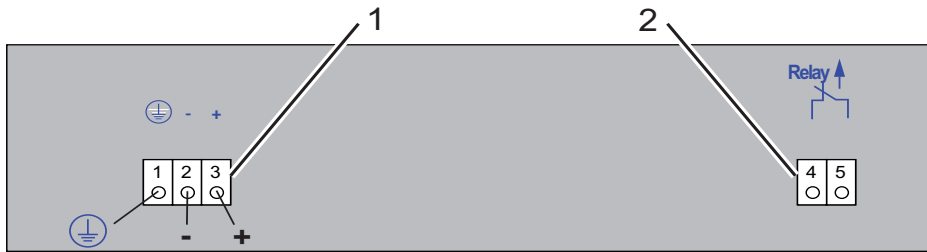

Figure 10: Power supply unit “C”, DC voltage 52 [“General technical data”](#)
 Connection for
 1 - supply voltage
 2 - signal contact

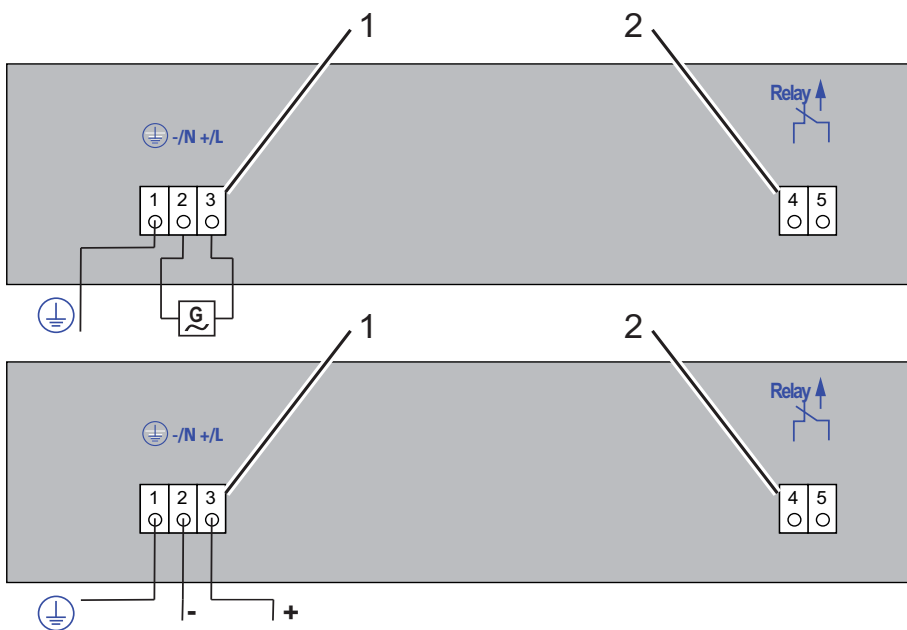

Figure 11: Power supply unit “G” ([see on page 52 “General technical data”](#)):
 AC voltage (pictured above) or DC voltage (pictured below)
 Connecting
 1 - Supply voltage
 2 - Signal contact

Connection	Type “C”	Type “G” VDC	Type “G” VAC
\perp , pin 1	Protective conductor	Protective conductor	Protective conductor
-/N, pin 2	Minus terminal of the supply voltage	Minus terminal of the supply voltage	Neutral conductor
+/L, pin 3	Plus terminal of the supply voltage	Plus terminal of the supply voltage	Line conductor

Table 7: Pin assignment of spring-loaded terminal for voltage supply

Note: Use copper wire with cross-section AWG 16 to AWG 12 (0.75 mm² to 3.0 mm²) and stripping length 12 mm.

For **every** supply voltage to be connected, perform the following steps:

- Ensure the required conditions for connecting the supply voltage.
[See “Supply voltage” on page 7.](#)
- To insert the cable, you open the terminal lock by positioning the screwdriver as illustrated below and pressing on the lever.
- Connect the protective conductor according to the pin assignment on the device with the clamp.

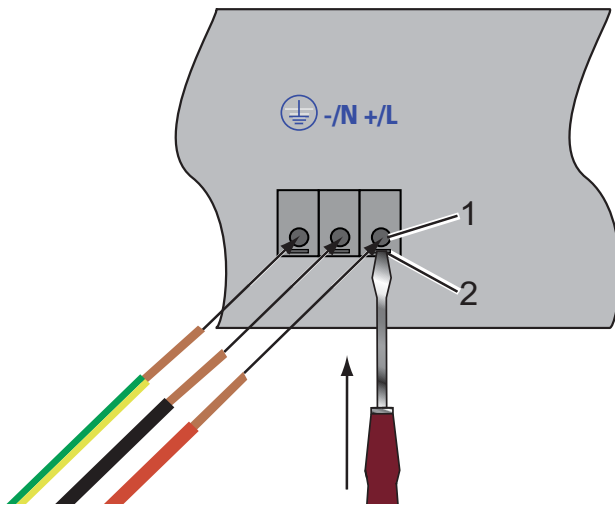

*Figure 12: Connecting the supply voltage via the 3-pin spring-loaded terminal
1 - Field connection terminal for supply voltage
2 - Terminal lock*

- Connect the wires according to the pin assignment on the device with the clamps.

2.2.2 Connecting the plugged voltage supply (power supply units “L” and “M”)

WARNING

ELECTRIC SHOCK

Connect only a supply voltage that corresponds to the type plate of your device.

Never insert sharp objects (small screwdrivers, wires, etc.) into the connection terminals for electric conductors, and do not touch the terminals.

Failure to follow these instructions can result in death, serious injury, or equipment damage.



Note: Note the permitted voltage ranges for devices with certification type “T” (EN 50155 railway (train) - see product code position 38 in [table 1](#)).

Relevant for North America:

The torque for tightening the supply voltage terminal block on the device is 4.5 lb-in (0.51 Nm).

The terminal blocks for devices with power unit type “M” (type “L”) are coded to prevent them from being accidentally connected to devices with power unit type “L” (type “M”).

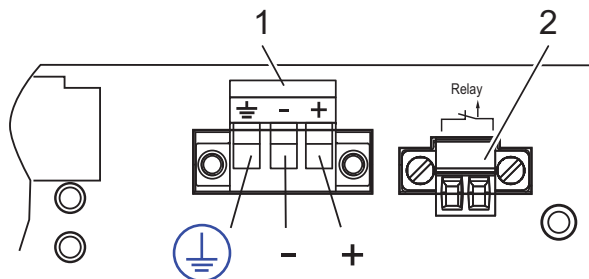

Figure 13: Power supply unit “L”, DC voltage (see on page 52 “General technical data”)

Connecting

1 - Supply voltage

2 - Signal contact

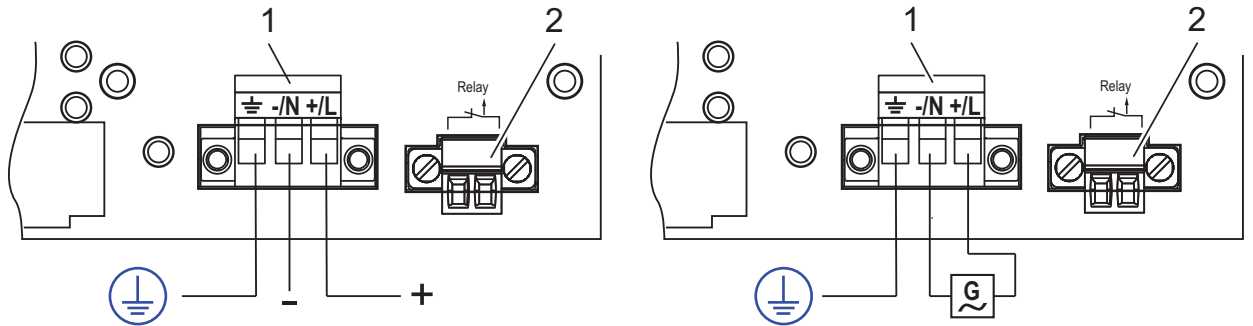

Figure 14: Power supply unit “M” (see on page 52 “General technical data”):
AC voltage (pictured on right) or DC voltage (pictured on left)

Connecting

1 - Supply voltage

2 - Signal contact

Connection	Type “L”	Type “M” VDC	Type “M” VAC
⏚ , pin 1	Protective conductor	Protective conductor	Protective conductor
-/N, pin 2	Minus terminal of the supply voltage	Minus terminal of the supply voltage	Neutral conductor
+/L, pin 3	Plus terminal of the supply voltage	Plus terminal of the supply voltage	Line conductor

Table 8: Pin assignment of terminal block for voltage supply

For **every** supply voltage to be connected, perform the following steps:

- Ensure the required conditions for connecting the supply voltage.
See “Supply voltage” on page 7.
- Remove the power connector from the device.
- Connect the protective conductor according to the pin assignment on the device with the clamp.
- Connect the wires according to the pin assignment on the device with the clamps.
- Mount the terminal block on the device using screws.

2.2.3 Connecting the signal contact

Relevant for North America:

The torque for tightening the terminal block for the signal contact on the device is 3 lb-in (0.34 Nm).

Note: Use copper wire with cross-section AWG 20 to AWG 12 (0.5 mm² to 3.0 mm²) and stripping length 12 mm.

For every signal contact to be connected, make sure the following requirements are met:

- ▶ The electrical wires are voltage-free.
- ▶ The connected voltage is limited by a current limitation device or a fuse. Observe the electrical threshold values for the signal contact.

For every signal contact to be connected, perform the following steps:

- For plugged connections: connect the signal contact lines with the terminal block connections. Mount the terminal block on the device using screws.
- To insert the cable, you open the terminal lock by positioning the screwdriver as illustrated below and pressing on the lever.
- For terminal connections: connect the signal contact lines to the connection terminals.

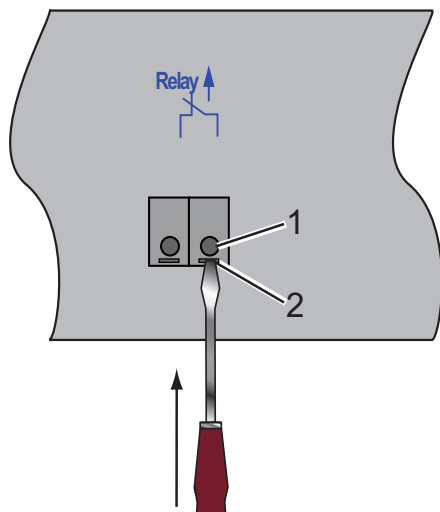

Figure 15: Connecting the switching voltage via the 2-pin spring-loaded terminal
1 - Field connection terminal for switching voltage
2 - Terminal lock

2.3 Installing and grounding the device



WARNING

ELECTRIC SHOCK

Install this device solely in a switch cabinet or in an operating site with restricted access, to which maintenance staff have exclusive access.

Failure to follow these instructions can result in death, serious injury, or equipment damage.

Note: The shielding ground of the connectable twisted pair cables is connected to the front panel as a conductor.

2.3.1 Mounting in a switch cabinet

Install the device in the 19" switch cabinet using sliding or mounting rails. This provides a more stable position of your device in environments subject to vibration.

For more information on sliding/mounting rails and how to install them, please contact your switch cabinet manufacturer.

The devices are designed to be mounted in a 19" switch cabinet.

- Verify that there is sufficient ventilation. Bauen Sie gegebenenfalls einen Lüfter ein, um ein Überhitzen des Gerätes zu vermeiden.
- Measure the depth of the 19" cabinet so that all the lines to be connected can be fed in easily.
- Assemble the sliding or mounting rails in the 19" switch cabinet as specified by the manufacturer.

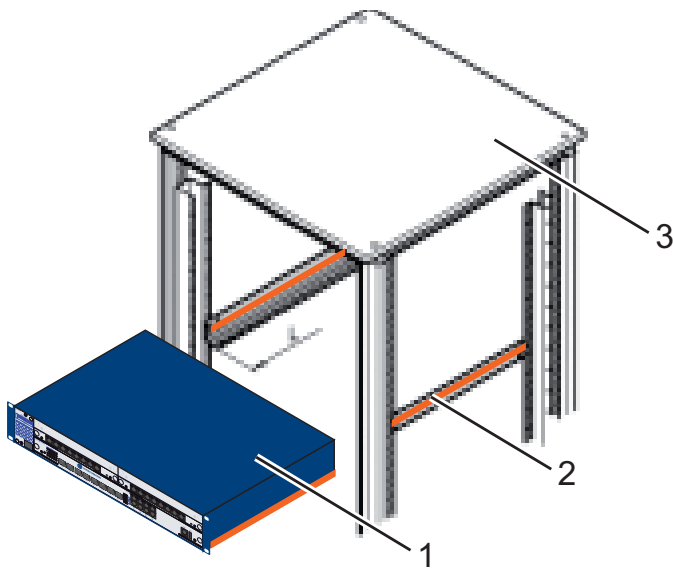

Figure 16: Assembly in a switch cabinet with sliding/mounting rails

- 1 - MACH 1000 device
- 2 - sliding/mounting rail
- 3 - 19" switch cabinet

On delivery, two brackets are attached to the sides of the device (see figure below).

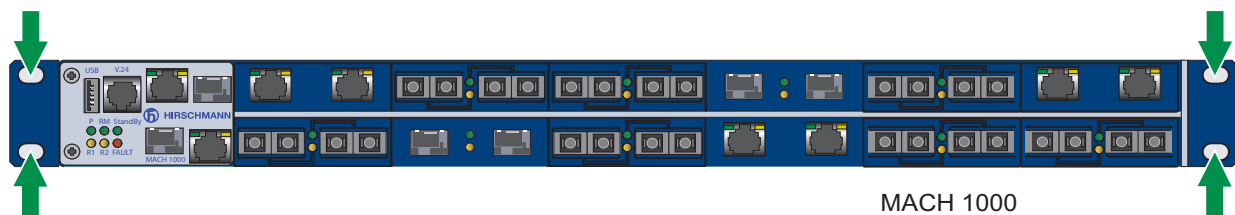

Figure 17: Mounting in the switch cabinet

- Fasten the device by screwing the brackets to the switch cabinet.

Note: When operating the device in an environment with strong vibrations, you have the option to additionally fasten the device to the switch cabinet using 2 holding brackets on the back of the device. You can obtain additional brackets as accessories ([see on page 61 "Accessories"](#)).

2.3.2 Vertical mounting on the wall

WARNING

FIRE HAZARD

Install the device in a fire protected shell if you are mounting it vertically.

Failure to follow these instructions can result in death, serious injury, or equipment damage.

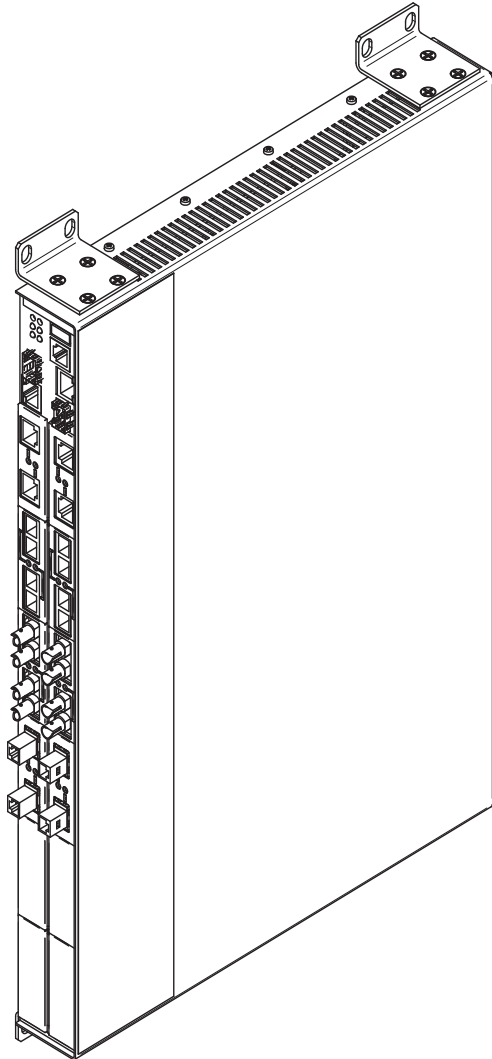

- Use the pre-mounted brackets included in the delivery.
- Additionally attach 2 brackets to the back of the device.
You can obtain additional brackets as accessories ([see on page 61 "Accessories"](#)).
- Fasten the device by screwing the brackets to the wall.

2.3.3 Grounding the device

The device is grounded via the separate grounding screw on the back of the device.

2.4 Operating the device

When you connect the supply voltage, you start up the device.

2.5 Connecting data cables

2.5.1 Twisted Pair ports

In general, adhere to the following recommendations for data cable connections in environments with high electrical interference levels:

- ▶ Keep the length of the data cables as short as possible.
- ▶ Use optical data cables for the data transmission between the buildings.
- ▶ When using copper cables, provide a sufficient separation between the power supply cables and the data cables. Ideally, install the cables in separate cable channels.
- ▶ Verify that power supply cables and data cables do not run parallel over longer distances, and that ideally they are installed in separate cable channels. If reducing the inductive coupling is necessary, verify that the power supply cables and data cables cross at a 90° angle.
- ▶ Use shielded cables (SF/UTP cables as per ISO/IEC 11801:2002).
- Connect the data cables according to your requirements.

[See “10/100/1000 Mbit/s twisted pair port” on page 28.](#)

[See “10/100 Mbit/s twisted pair port” on page 29.](#)

[See “10/100 Mbit/s PoE port” on page 29.](#)

2.5.2 Optical fiber ports

Verify that you connect LH ports only with LH ports, SX ports only with SX ports, and LX ports only with LX ports.

- Connect the data cables according to your requirements.

[See “1000 Mbit/s F/O port” on page 30.](#)

[See “10/100 Mbit/s PoE port” on page 29.](#)

[See “10 Mbit/s F/O port” on page 30.](#)

2.6 Installing an SFP transceiver (optional)

Use only Hirschmann SFP transceivers which are suitable for usage with the device.

See [“Accessories” on page 61](#).

Proceed as follows:

- Remove the protection cap from the SFP transceiver.
- Push the transceiver with the lock closed into the slot until it latches in.

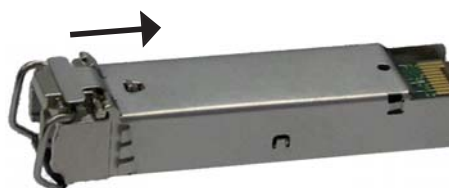

3 Making basic settings

The IP parameters must be entered when the device is installed for the first time. The device provides 6 options for configuring IP addresses:

- ▶ Entry via V.24 connection
- ▶ Entry using the HiDiscovery protocol via the application HiDiscovery or Industrial HiVision
- ▶ Configuration via BOOTP
- ▶ Configuration via DHCP
- ▶ Configuration via DHCP Option 82
- ▶ Auto Configuration Adapter

Further information on the basic settings of the device can be found in the “Basic Configuration” user manual on the CD/DVD.

3.0.1 Default settings

- ▶ IP address: The device looks for the IP address using DHCP
- ▶ Password for management:
Login: user; password: public (read only)
Login: admin; password: private (read and write)
- ▶ Parameters that can be set via the management are set to pre-defined values in accordance with the MIB
- ▶ V.24 data rate: 9,600 Baud
- ▶ Ring redundancy: disabled
- ▶ Ethernet ports: link status is not evaluated (signal contact)
- ▶ Optical 100 Mbit/s ports: 100 Mbit/s, full duplex
All other ports: autonegotiation
- ▶ Ring manager disabled
- ▶ Stand-by coupling: disabled
Port 4 = control port, port 3 = coupling port for red. Ring coupling

4 Monitoring the ambient air temperature

Operate the device below the specified maximum ambient air temperature exclusively.

See [“General technical data” on page 52](#).

The ambient air temperature is the temperature of the air at a distance of 2 in (5 cm) from the device. It depends on the installation conditions of the device, e.g. the distance from other devices or other objects, and the output of neighboring devices.

The temperature displayed in the CLI and the GUI is the internal temperature of the device. It is higher than the ambient air temperature. The maximum internal temperature of the device named in the technical data is a guideline that indicates to you that the maximum ambient air temperature has possibly been exceeded.

5 Maintenance and service

- When designing this device, Hirschmann largely avoided using high-wear parts. The parts subject to wear and tear are dimensioned to last longer than the lifetime of the product when it is operated normally. Operate this device according to the specifications.
- Relays are subject to natural wear. This wear depends on the frequency of the switching operations. Check the resistance of the closed relay contacts and the switching function depending on the frequency of the switching operations.
- Hirschmann are continually working on improving and developing their software. Check regularly whether there is an updated version of the software that provides you with additional benefits. You find information and software downloads on the Hirschmann product pages on the Internet (www.hirschmann.com).
- Depending on the degree of pollution in the operating environment, check at regular intervals that the ventilation slots in the device are not obstructed.

Note: You will find information about the complaints and returns procedures on the Internet under

<http://www.beldensolutions.com/en/Service/Repairs/index.phtml> .

6 Disassembly

6.1 Removing the device

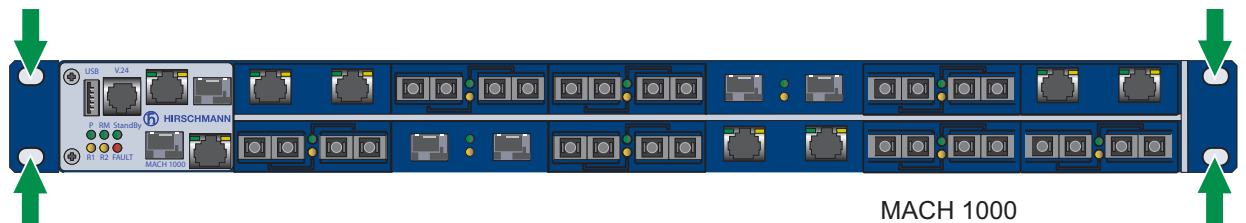

Proceed as follows:

- Disconnect the data cables.
- Disable the supply voltage.
- Disconnect the grounding.
- To detach the device from the switch cabinet or the wall, remove the screws from the brackets on the device.

6.2 Removing an SFP transceiver (optional)



Proceed as follows:

- Pull the SFP transceiver out of the slot by means of the opened lock.
- Close the SFP transceiver with the protective cap.

7 Technical data

■ General technical data

Dimensions W × H × D	Devices with terminal connection voltage supply (power unit types C and G)	448 × 310 × 44 mm (without brackets)
	Devices with pluggable voltage supply (power unit types T and M)	448 × 345 × 44 mm (without brackets)
Weight (incl. redundant power unit or PoE power unit)	MAR1020-... fully equipped	max. 4.6 kg
	MAR1030-... fully equipped	max. 4.7 kg
	MAR1120-... fully equipped (incl. redundant power unit)	max. 5.4 kg
	MAR1130-... fully equipped (incl. redundant power unit)	max. 5.5 kg
	MAR1122-... fully equipped	max. 5.5 kg
	MAR1132-... fully equipped	max. 5.6 kg
	MAR1022-... fully equipped	max. 4.7 kg
	MAR1032-... fully equipped	max. 4.8 kg
Weight	MAR1020-... basic device	approx. 3.9 kg
	MAR1030-... basic device	approx. 4.0 kg
	MAR1120-... basic device	approx. 4.7 kg
	MAR1130-... basic device	approx. 4.8 kg
	MAR1122-... basic device	approx. 5.1 kg
	MAR1132-... basic device	approx. 5.2 kg
	MAR1022-... basic device	approx. 4.3 kg
	MAR1032-... basic device	approx. 4.4 kg
	Optional PoE power unit	approx. 0.3 kg
	Optional second power unit	additional approx. 0.3 kg
	Per 6 ports (3 modules)	additional approx. 0.1 kg
	Per M12 module	additional approx. 0.09 kg
Power supply types G and M	Rated voltage range AC	100 V ... 240 V, 50 Hz ... 60 Hz
	Voltage range AC incl. maximum tolerances	90 V ... 265 V, 47 Hz ... 63 Hz
	Rated voltage range DC	110 V ... 250 V Devices with certification type "T": 110 V
	Voltage range DC incl. maximum tolerances	77 V ... 300 V
	Connection type G	3-pin spring-loaded terminal for copper wire with cross-section AWG 20-12 (0.5 mm ² ... 3.0 mm ²) and stripping length 12 mm
	Connection type M	3-pin terminal block
	Power loss buffer	> 20 ms at 230 V AC
	Peak inrush current	14 A

Power supply types C and L	Rated voltage range DC	24 V ... 48 V Devices with certification type "T": 36 V
	Voltage range DC incl. maximum tolerances	18 V ... 60 V
	Connection type C	3-pin spring-loaded terminal for copper wire with cross-section AWG 20-12 (0.5 mm ² ... 3.0 mm ²) and stripping length 12 mm
	Connection type L	3-pin terminal block
	Power loss buffer	> 10 ms at 20.4 V DC
	Peak inrush current	15 A
Input voltage for device variants with PoE	Rated voltage range DC	110 V ... 250 V
	Voltage range DC incl. maximum tolerances	77 V ... 300 V
	Rated voltage range AC	110 V ... 230 V
	Voltage range AC incl. maximum tolerances	90 V ... 265 V, 47 Hz ... 63 Hz
Output voltage for device variants with PoE	48 V DC ± 5%	
Back-up fuse	Power unit types C and G	Nominal rating: 6.3 A Characteristic: slow blow
	Power unit types L and M	Nominal rating: 2.5 A Characteristic: slow blow
Signal contact	Nominal value for AC	$I_{\max} = 2 \text{ A}$ at $U_{\max} = 230 \text{ V}$
	Nominal value for DC	$I_{\max} = 2 \text{ A}$ at $U_{\max} = 30 \text{ V}$ $I_{\max} = 0.2 \text{ A}$ at $U_{\max} = 125 \text{ V}$ $I_{\max} = 0.1 \text{ A}$ at $U_{\max} = 250 \text{ V}$
	Connection type for power unit types C and G	2-pin spring-loaded terminal for copper wire with cross-section AWG 20-12 (0.5 mm ² ... 3.0 mm ²) and stripping length 12 mm
	Connection type for power unit types L and M	2-pin terminal block

Climatic conditions during operation	Minimum clearance around the device	Top and bottom sides of device: 1.97 in (5 cm)		
		Left and right device side: 3.94 in (10 cm)		
	Ambient air temperature ^a	Standard	+32 °F ... +140 °F (0 °C ... +60 °C)	
		Extended ^{b c d e f}	-40 °F ... +185 °F (-40 °C ... +85 °C)	
	Humidity	5 % ... 95 % (non-condensing)		
Air pressure	Up to 2000 m (795 hPa), higher altitudes on request			
Climatic conditions during storage	Ambient air temperature ^a	Standard	-40 °F ... +185 °F (-40 °C ... +85 °C)	
		Extended	-40 °F ... +185 °F (-40 °C ... +85 °C)	
	Humidity	5 % ... 95 % (non-condensing)		
	Air pressure	Up to 2000 m (795 hPa), higher altitudes on request		
Pollution degree	2			
Protection classes	Laser protection	Class 1 according to EN 60825-1		
	Degree of protection	IP 30		

- a. Temperature of the ambient air at a distance of 2 inches (5 cm) from the device
- b. If you are using SFP modules without the “EEC” extension, an operating temperature of +32 °F to +140 °F (0 °C to +60 °C) applies for your device ([see on page 61 “Accessories”](#)).
- c. For devices equipped with more than 14 F/O ports, a gradually reduced maximum operating temperature applies. When equipped with 28 F/O ports, the maximum operating temperature is +158 °F (+70 °C).
- d. MACH 1000 Device equipped with Fast Ethernet modules “GG” (Singlemode Long Haul FX DSC 200 km): +32 °F to +140 °F (0 °C to +60 °C).
- e. -40 °F to +158 °F (-40 °C to +70 °C) for devices with PoE, for devices with FL ports and for devices with 4 Gigabit Ethernet ports.
- f. Relevant for explosion hazard areas and approval ISA 12.12.01 Class I, Division 2, UL508: The maximum operating temperature is for device variants “U” and “F” +158 °F (+70 °C) and for device variant “S” +140 °F (60 °C) ([see on page 9 “Use in Hazardous Locations”](#)).

■ Dimension drawings

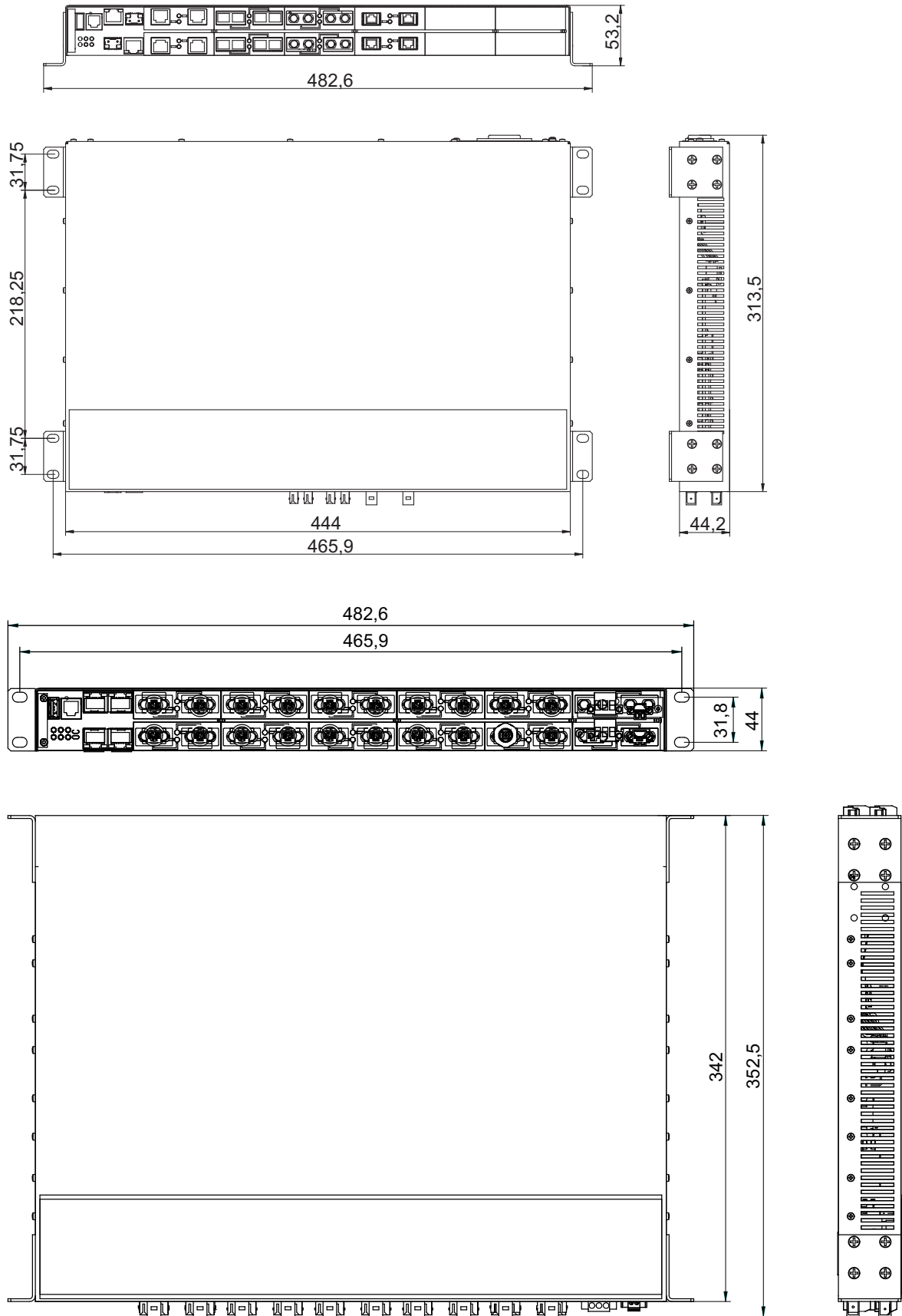

Figure 18: MACH 1000, dimensions of device variants

■ EMC and immunity

EMC interference immunity IEC/EN 61850-3:2002 EMI TYPE tests, test in comp. with	Description	Test level
IEC/EN 61000-4-2	Electrostatic discharge	
	Contact discharge	± 8 kV
	Air discharge	± 15 kV
IEC/EN 61000-4-3	Electromagnetic field	
	80 MHz ... 2700 MHz	20 V/m
IEC/EN 61000-4-4	Fast transients (burst)	
	DC Power Line	± 4 kV
	AC Power Line	± 4 kV
	Data line	± 4 kV
IEC/EN 61000-4-5	Voltage surges	
	DC Power Line	± 2 kV line/ground; ± 1 kV line/line
	AC Power Line	± 4 kV line/ground; ± 2 kV line/line
	Data line	± 4 kV line/ground
IEC/EN 61000-4-6	Conducted disturbances	
	150 kHz ... 80 MHz	10 V
IEC/EN 61000-4-12	Damped oscillation	
	DC Power Line	± 2,5 kV line/earth; ± 1 kV line/line
	AC Power Line	± 2,5 kV line/earth; ± 1 kV line/line
	Data line	± 2,5 kV line/earth; ± 1 kV line/line
IEC 60255-5	dielectric strength	
	DC Power Line, power unit type „C“, „L“	500 V AC
	AC Power Line, power unit type „G“, „M“	2000 V AC
	DC Power Line, power unit type „G“, „M“	2000 V AC
	signal contact type „C“, „L“ and „G“, „M“	2000 V AC

EMC interference immunity IEEE 1613:2009 EMI TYPE tests, test in comp. with	Description	Test level
IEEE C37.90.3	Electrostatic discharge	
	Contact discharge	± 8 kV
	Air discharge	± 15 kV
IEEE C37.90.2	Electromagnetic field	
	80 MHz ... 1000 MHz	35 V/m (peak)
IEEE C37.90.1	Fast transients (burst)	
	DC Power Line	± 4 kV
	AC Power Line	± 4 kV
	Data line	± 4 kV
IEEE C37.90.1	Damped oscillation	
	DC Power Line	± 2,5 kV line/earth; ± 1 kV line/line
	AC Power Line	± 2,5 kV line/earth; ± 1 kV line/line
	Data line	± 2,5 kV line/earth; ± 1 kV line/line
IEEE C37.90	H.V. Impulse	
	DC Power Line	± 5 kV line/earth
	AC Power Line	± 5 kV line/earth
IEEE C37.90	dielectric strength	
	DC Power Line, power unit type „C“, „L“	500 V AC
	AC Power Line, power unit type „G“, „M“	2000 V AC
	DC Power Line, power unit type „G“, „M“	2000 V AC
	signal contact type „C“, „L“ and „G“, „M“	2000 V AC

EMC interference emission

EN 55022	Class A
FCC 47 CFR Part 15	Class A
German Lloyd	Classification + Construction Guidelines VI-7-3 Part 1 Ed.2001

Environment type tests, test in comp. with	Description	Test level
IEC 60068-2-1	Cold	-40 °F (-40 °C), 16 hours
IEC 60068-2-2	Dry heat	+185 °F (+85 °C), 16 hours
IEC 60068-2-30	Relative humidity	95 % (non condensing) 131 °F (55 °C), 4 cycles
IEC 60068-2-6	Vibration, test Fc	2 - 9 Hz with 3 mm amplitude 1 g at 9 - 150 Hz 1.5 g at 200 - 500 Hz
IEC 60068-2-27	Shock, test Ea	15 g at 11 ms

■ Network range

Note: The line lengths specified for the transceivers apply for the respective fiber data (fiber attenuation and BLP/dispersion).

Product code M-SFP-...	Wave length	Fiber	System attenuation	Example for F/O line length ^a	Fiber attenuation	BLP ^b /dispersion
-SX/LC...	MM 850 nm	50/125 μm	0-7.5 dB	0-550 m	3.0 dB/km	400 MHz×km
-SX/LC...	MM 850 nm	62.5/125 μm	0-7.5 dB	0-275 m	3.2 dB/km	200 MHz×km
-MX/LC	MM 1310 nm	50/125 μm	0-8 dB	2 km ^c	1.0 dB/km	500 MHz×km
-MX/LC	MM 1310 nm	62.5/125 μm	0-8 dB	1 km	1.0 dB/km	500 MHz×km
-LX/LC...	MM 1310 nm ^d	50/125 μm	0-10.5 dB	0-550 m	1.0 dB/km	800 MHz×km
-LX/LC...	MM 1310 nm ^c	62.5/125 μm	0-10.5 dB	0-550 m	1.0 dB/km	500 MHz×km
-LX/LC...	SM 1310 nm	9/125 μm	0-10.5 dB	0-20 km ^e	0.4 dB/km	3.5 ps/(nm×km)
-LX+/LC...	SM 1310 nm	9/125 μm	5-20 dB	14-42 km	0.4 dB/km	3.5 ps/(nm×km)
-LH/LC...	LH 1550 nm	9/125 μm	5-22 dB	23-80 km	0.25 dB/km	19 ps/(nm×km)
-LH+/LC	LH 1550 nm	9/125 μm	15-30 dB	71-108 km	0.25 dB/km	19 ps/(nm×km)
-LH+/LC	LH 1550 nm	9/125 μm	15-30 dB	71-128 km	0.21 dB/km (typically)	19 ps/(nm×km)

Table 9: Fiber port 1000BASE-FX (SFP fiber optic Gigabit Ethernet Transceiver)

- a. including 3 dB system reserve when compliance with the fiber data is observed
- b. Using the bandwidth length product is inappropriate for expansion calculations.
- c. Distances of up to 3 km reachable, 1000 MHz×km (1300 nm)
- d. With F/O adapter compliant with IEEE 802.3-2002 clause 38 (single-mode fiber offset-launch mode conditioning patch cord)
- e. including 2.5 dB system reserve when compliance with the fiber data is observed

Product code M-SFP-BIDI...	Wave length TX	Wave length RX	Fiber	System attenuation	Example for F/O line length ^a	Fiber attenuation	Dispersion
Type A LX/LC EEC	SM 1310 nm	1550 nm	9/125 μm	0-11 dB	0-20 km	0.4 dB/km	3.5 ps/(nm×km)
Type B LX/LC EEC	SM 1550 nm	1310 nm	9/125 μm	0-11 dB	0-20 km	0.25 dB/km	19 ps/(nm×km)
Type A LH/LC EEC	LH 1490 nm	1590 nm	9/125 μm	5-24 dB	23-80 km	0.25 dB/km	19 ps/(nm×km)
Type B LH/LC EEC	LH 1590 nm	1490 nm	9/125 μm	5-24 dB	23-80 km	0.25 dB/km	19 ps/(nm×km)

Table 10: F/O port (bidirectional Gigabit Ethernet SFP Transceiver)

- a. including 3 dB system reserve when compliance with the fiber data is observed

Product code M-FAST-SFP-...	Wave length	Fiber	System attenuation	Example for F/O line length ^a	Fiber attenuation	BLP/dispersion
-MM/LC...	MM 1310 nm	50/125 μm	0-8 dB	0-5 km	1.0 dB/km	800 MHz*km
-MM/LC...	MM 1310 nm	62.5/125 μm	0-11 dB	0-4 km	1.0 dB/km	500 MHz*km
-SM/LC...	SM 1310 nm	9/125 μm	0-13 dB	0-25 km	0.4 dB/km	3.5 ps/(nm*km)
-SM+/LC...	SM 1310 nm	9/125 μm	10-29 dB	25-65 km	0.4 dB/km	3.5 ps/(nm*km)
-LH/LC...	SM 1550 nm	9/125 μm	10-29 dB	47-104 km	0.25 dB/km	19 ps/(nm*km)
-LH/LC...	SM 1550 nm	9/125 μm	10-29 dB	55-140 km	0.18 dB/km ^b	18 ps/(nm*km)

Table 11: Fiber port 100BASE-FX (SFP fiber optic Fast Ethernet Transceiver)

- a. including 3 dB system reserve when compliance with the fiber data is observed
b. with ultra-low-loss optical fiber

Product code	Wave length	Fiber	System attenuation	Example for F/O line length ^a	Fiber attenuation	BLP/dispersion
-FF	MM 820 nm	50/125 μm	0-9.5 dB	0-2.1 km	3.0 dB/km	400 MHz*km
-FF	MM 820 nm	62.5/125 μm	0-12.5 dB	0-3.0 km	3.2 dB/km	200 MHz*km

Table 12: F/O port 10BASE-FL

- a. including 3 dB system reserve when compliance with the fiber data is observed

Product code	Wave length	Fiber	System attenuation	Example for F/O line length ^a	Fiber attenuation	BLP/dispersion
-JJ, -MM, -NN, -BB	MM 1300 nm	50/125 μm	0-8 dB	0-5 km	1.0 dB/km	800 MHz*km
-JJ, -MM, -NN, -BB	MM 1300 nm	62.5/125 μm	0-11 dB	0-4 km	1.0 dB/km	500 MHz*km
-VV, -UU	SM 1300 nm	9/125 μm	0-16 dB	0-30 km	0.4 dB/km	3.5 ps/(nm*km)
-LL	LH 1550 nm	9/125 μm	3-29 dB	14-104 km	0.25 dB/km;	19 ps/(nm*km)
-GG	LH 1550 nm	9/125 μm	14-47 dB	67-176 km	0.25 dB/km	19 ps/(nm*km)

Table 13: F/O port 100BASE-FX

- a. including 3 dB system reserve when compliance with the fiber data is observed

MM = Multimode, SM = Singlemode, LH = Singlemode Longhaul

TP port
Length of a twisted pair segment

max. 100 m (cat5e cable with 1000BASE-T)

Table 14: TP port 10BASE-T / 100BASE-TX / 1000BASE-T

■ Power consumption/power output

Name	Power consumption	Power output
Basic devices		
MAR1020-... basic device (without Fast Ethernet modules)	7.5 W	25.6 Btu (IT)/h
MAR1030-... basic device (incl. 2 Gigabit Ethernet module combo ports, without Fast Ethernet modules)	10.5 W	35.9 Btu (IT)/h
MAR 1x3y-4O... basic device (x = 0 or 1, y = 0 or 2)	11.5 W	39.2 Btu (IT)/h
MAR 1x3y-4T... basic device (x = 0 or 1, y = 0 or 2)	14.5 W	49.5 Btu (IT)/h
MAR 1x3y-OT... basic device (x = 0 or 1, y = 0 or 2)	13.0 W	44.4 Btu (IT)/h
Fast Ethernet modules		
additionally for each Fast Ethernet FX module	2.0 W	6.9 Btu (IT)/h
additionally for each Fast Ethernet TX module	0.4 W	1.4 Btu (IT)/h
additionally for each PoE module	38.0 W	130.0 Btu (IT)/h
Examples		
MAR1020-99TTTTTTTTTTTTTTTTTTTTTTTTTTTTTUG9HPHHXX.X	12.3 W	42.0 Btu (IT)/h
MAR1020-99TTTTTTTTTTTTTMMMMMMMMMMMMMUG9HPHHXX.X	21.9 W	74.8 Btu (IT)/h
MAR1020-99MMMMMMMMMMMMMMMMMMMMMMMMMMMMMUG9HPHHXX.X	31.5 W	107.5 Btu (IT)/h
MAR1030-CCTTTTTTTTTTTTTTTTTTTTTTTTTTTTUG9HPHHXX.X	15.3 W	52.2 Btu (IT)/h
MAR1030-CCTTTTTTTTTTTTTTMMMMMMMMMMMMMUG9HPHHXX.X	24.9 W	85.0 Btu (IT)/h
MAR1030-CCMMMMMMMMMMMMMMMMMMMMMMMMMMMMMUG9HPHHXX.X	34.5 W	117.8 Btu (IT)/h
MAR1030-4TMMMMMMMMMMMMMMMMMMMMMMMMMMMMMUG9HPHHXX.X	38.5 W	131.4 Btu (IT)/h
MAR1032-4TTTRMMMMMMMMMMMMMMMMMMMMMMMMMUGGHPHHXX.X, non-PD (powered device)	35.3 W	120.5 Btu (IT)/h
MAR1132-4OTTRMMMMMMMMMMMMMMMMMMMMM9999UGGHPHHXX.X, non-PD (powered device)	28.3 W	96.6 Btu (IT)/h
MAR1032-4TTTRMMMMMMMMMMMMMMMMMMMMMMMMMUGGHPHHXX.X, 4 x Class0-PD (powered device)	111.3 W	380.5 Btu (IT)/h
MAR1132-4OTTRMMMMMMMMMMMMMMMMMMMMM9999UGGHPHHXX.X, 4 x Class0-PD (powered device)	104.3 W	356.6 Btu (IT)/h

■ Order numbers/product description

Combination options and device names (see table 1).

■ Scope of delivery

Device	Scope of delivery
MAR...	MAR... device Installation user manual CD/DVD

■ Accessories

Note: Please note that products recommended as accessories may have characteristics that do not fully correspond to those of the corresponding product. This may limit their possible usage range in the overall system.

Gigabit Ethernet SFP transceiver	Order number
M-SFP-SX/LC	943 014-001
M-SFP-SX/LC EEC	943 896-001
M-SFP-MX/LC	942 035-001
M-SFP-LX/LC	943 015-001
M-SFP-LX/LC EEC	943 897-001
M-SFP-LX+/LC	942 023-001
M-SFP-LX+/ LC EEC	942 024-001
M-SFP-LH/LC	943 042-001
M-SFP-LH/LC EEC	943 898-001
M-SFP-LH+/LC	943 049-001
Bidirectional Gigabit Ethernet SFP transceiver	Order number
M-SFP-BIDI Type A LX/LC EEC	943 974-001
M-SFP-BIDI Type B LX/LC EEC	943 974-002
M-SFP-BIDI Type A LH/LC EEC	943 975-001
M-SFP-BIDI Type B LH/LC EEC	943 975-002
M-SFP-BIDI Bundle LX/LC EEC (type A + B)	943 974-101
M-SFP-BIDI Bundle LH/LC EEC (type A + B)	943 975-101
Fast Ethernet SFP transceiver	Order number
M-FAST SFP-TX/RJ45	942 098-001
M-FAST SFP-TX/RJ45 EEC	942 098-002

The following operating conditions apply to twisted pair transceivers:

- ▶ Usable with:
 - HiOS as of software version 03.0.00
 - for PRP ports on RSP devices, as of software version 02.0.01
 - for PRP ports on EES devices, as of software version 02.0.02
 - Classic switch software as of software version 08.0.00
 - HiSecOS ab Software-Version 01.2.00
- ▶ Longer RSTP switching times and link loss detection times compared to twisted pair ports provided by the device directly.
- ▶ Not applicable for combo ports.
- ▶ Not applicable for ports which support only Gigabit Ethernet.
- ▶ To set autocrossing manually is currently not possible.

Fast Ethernet SFP transceiver	Order number
M-FAST SFP-MM/LC	943 865-501
M-FAST SFP-MM/LC EEC	943 945-001
M-FAST SFP-SM/LC	943 866-001
M-FAST SFP-SM/LC EEC	943 945-501
M-FAST SFP-SM+/LC	943 867-001
M-FAST SFP-SM+/LC EEC	943 945-501
M-FAST SFP-LH/LC	943 868-001
M-FAST SFP-LH/LC EEC	943 945-501

Other accessories	Order number
AutoConfiguration Adapter ACA 21-USB (EEC)	943 271-003
Terminal cable	943 301-001
3-pin High Voltage Interlock terminal block (50 pcs.)	943 845-008
3-pin Low Voltage Interlock terminal block (50 pcs.)	943 845-011
3-pin Low Voltage Interlock terminal block (50 pcs.)	943 845-011
Bracket for fastening the housing	943 943-001
Dust protection cap (50 pieces) for RJ 45 sockets	943 936-001
Dust protection cap (25 pieces) for SFP slot	943 942-001
Network management software Industrial HiVision	943 156-xxx

■ Underlying technical standards

Name	
EN 61000-6-2	Electromagnetic compatibility (EMC) – Part 6-2: Generic standards – Immunity for industrial environments
EN 55022	Information technology equipment – Radio disturbance characteristics – Limits and methods of measurement
EN 60950-1	Information technology equipment – Safety – Part 1: General requirements
EN 61131-2	Programmable controllers – Part 2: Equipment requirements and tests
EN 50121-4	Railway applications - EMC - emitted interference and interference immunity for signal and telecommunication systems
EN 50155	Railway applications - Electronic equipment used on rolling stock
FCC 47 CFR Part 15	Code of Federal Regulations
Germanischer Lloyd	Rules for Classification and Construction VI-7-2 – GL
UL 508	Safety for Industrial Control Equipment
EN 61850-3	Communications networks and systems in stations
IEEE 1613	Standard Environment and Testing Requirements for Communication Networking Devices in Electric Power Substations
ANSI/ ISA 12.12.01	Nonincendive Electrical Equipment for Use in Class I and II, Division 2, and Class III, Divisions 1 and 2 Hazardous (Classified)Locations

Table 15: List of the technical standards

IEEE 802.1 D	Switching, GARP, GMRP, Spanning Tree Media access control (MAC) bridges (includes IEEE 802.1p Priority and Dynamic Multicast Filtering, GARP, GMRP)
IEEE 802.1 Q	Tagging Virtual Bridged Local Area Networks (VLAN Tagging, GVRP)
IEEE 802.1 w	Rapid Reconfiguration
IEEE 802.3	Ethernet

Table 16: List of IEEE standards

The device has an approval based on a specific standard only if the approval indicator appears on the device casing.

If your device has a shipping approval according to Germanischer Lloyd, you find the approval mark printed on the device label. You will find out whether your device has other shipping approvals on the Hirschmann website under www.hirschmann.com in the product information.

A Further Support

■ Technical Questions

For technical questions, please contact any Hirschmann dealer in your area or Hirschmann directly.

You will find the addresses of our partners on the Internet at <http://www.hirschmann.com>

Contact our support at <https://hirschmann-support.belden.eu.com>

You can contact us

in the EMEA region at

- ▶ Tel.: +49 (0)1805 14-1538
- ▶ E-mail: hac.support@belden.com

in the America region at

- ▶ Tel.: +1 (717) 217-2270
- ▶ E-mail: inet-support.us@belden.com

in the Asia-Pacific region at

- ▶ Tel.: +65 6854 9860
- ▶ E-mail: inet-ap@belden.com

■ Hirschmann Competence Center

The Hirschmann Competence Center is ahead of its competitors:

- ▶ Consulting incorporates comprehensive technical advice, from system evaluation through network planning to project planning.
- ▶ Training offers you an introduction to the basics, product briefing and user training with certification.

The current technology and product training courses can be found at <http://www.hicomcenter.com>

- ▶ Support ranges from the first installation through the standby service to maintenance concepts.

With the Hirschmann Competence Center, you have decided against making any compromises. Our client-customized package leaves you free to choose the service components you want to use.

Internet:

<http://www.hicomcenter.com>



HIRSCHMANN

A **BELDEN** BRAND