

OI810141**TEMPERATURE SENSORS • CONTACTLESS MEASUREMENT (INFRARED)****MECHANICAL DATA**

Ambient temperature	-20 °C ... 75 °C
Degree of protection (IP)	IP67
Housing design	Cylinder plain
Housing material	Stainless steel 1.4571
Measurement of material humidity	No
Sensor diameter	60 mm

ELECTRICAL DATA

Display	None
Hysteresis	5 %
Infrared measurement	Yes
Interface	No
Max. output current	400 mA
Measured value memory	No
Measurement of differential temperature	No
Measurement of rel. air humidity	No
Measuring range	0 °C ... 600 °C
Multiple display	No
No-load current	15 mA
Number of pins	5
Operating voltage	10 V ... 55 V
Separate sensor	No
Short-circuit-proof	Yes
Switching frequency	10 Hz
Thermocouple RTD	No
Type B thermocouple	No
Type E thermocouple	No
Type J thermocouple	No
Type K thermocouple	No
Type N thermocouple	No
Type of electrical connection	Plug-in connection

ELECTRICAL DATA

Type of switching function	Normally open contact (NO)
Type of switching output	PNP
Type R thermocouple	No
Type S thermocouple	No
Type T thermocouple	No
Voltage type	DC
With LED display	Yes

OPTICAL DATA

Angle of beam spread	2 °
----------------------	-----

CONNECTION

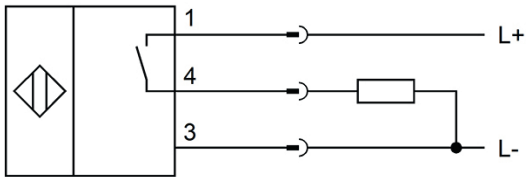

Colors: 1 = BN (brown), 3 = BU (blue), 4 = BK (black)

Functions: 1 = L+, 3 = L-, 4 = PNP NO

DIMENSIONAL DRAWING

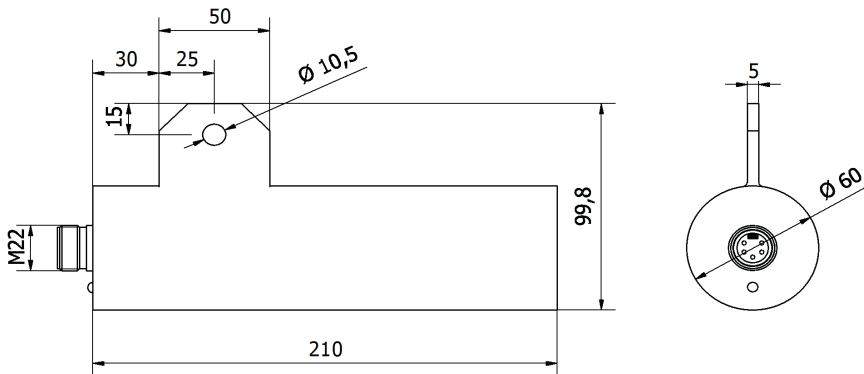

INSTALLATION



Mounting / Installation may only be carried out by a qualified electrician!

DISPOSAL



SAFETY WARNINGS

Before initial operation, please make sure to follow all safety instructions that may be provided in the product information!

