

CYLINDER SENSORS

Do you know where you stand?

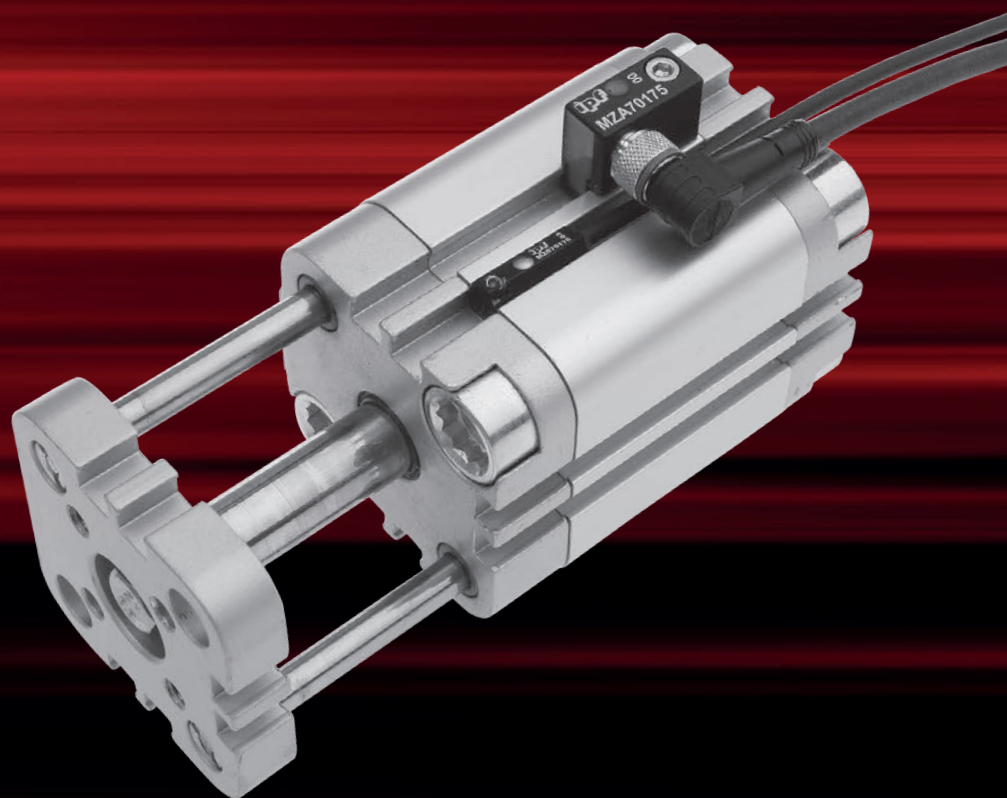

IPF ELECTRONIC

High-End in High-Tech.

CYLINDER SENSORS

THE RELIABLE CHOICE FOR POSITION DETERMINATION

In many automated applications, pneumatic cylinders have become nearly indispensable, for example, in molding tools and in drive, conveyor and handling technology. In these and many other areas of use, it is often necessary to receive a switching signal at certain piston positions. Ideally suited for this are our cylinder sensors, which query the position of piston rods in pneumatic cylinders contactlessly as well as wear-free and, thus, very reliably.

THE MANY ADVANTAGES OF FULLY ELECTRONIC SYSTEMS

**CONVINCING ARGUMENTS FOR WHY YOU SHOULD
CHOOSE OUR SOLUTIONS**

In practical use, our cylinder sensors must often withstand considerable stresses. These include not only high temperatures, but also extreme mechanical loads caused by vibrations, impacts, blows, etc., as well as the use of materials such as coolants, lubricants, oils, inks and cleaning agents and solvents, with which our sensors come into direct contact.

Regardless of what the surroundings demand of our devices, they always function trouble free – and do so over years or even decades.

The decisive reason: cylinder sensors are fully electronic solutions and, as a result, have numerous advantages over devices that use reed contacts for position sensing.

THIS MEANS THAT OUR SOLUTIONS ARE:

- / Highly reliable and operate wear free, since they have absolutely no moving parts
- / Extremely robust due to, among other reasons, the fully casted electronics and housing versions made of metal
- / Very temperature resistant due to a possible operating temperature range from -40°C to +130°C depending on sensor version
- / Extremely accurate, as – compared to devices with reed contacts – they feature higher accuracy with very good repeat accuracy
- / Highly precise due to very short travel paths
- / Extremely responsive, with a high switching frequency of up to 1kHz
- / Well protected, as they all feature degree of protection IP67

OPERATING PRINCIPLE

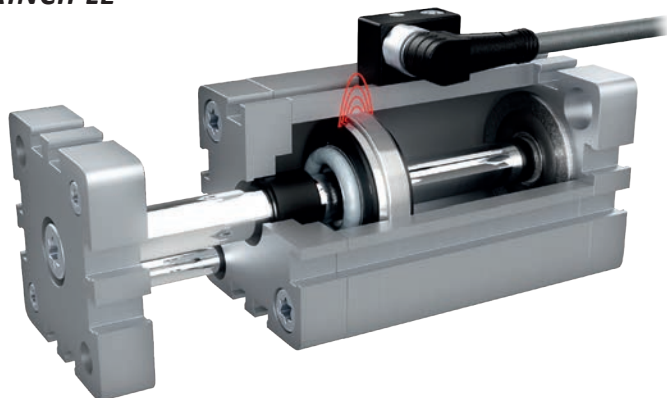

The sensor element located in the device detects the magnetic field of the ring magnet mounted on the piston rod.

APPLICATIONS

ROBUST FEATURE

Cylinder sensors on a special hydraulic cylinder that need to withstand the most extreme conditions, including high temperatures of up to +100°C and extraordinary mechanical loads.

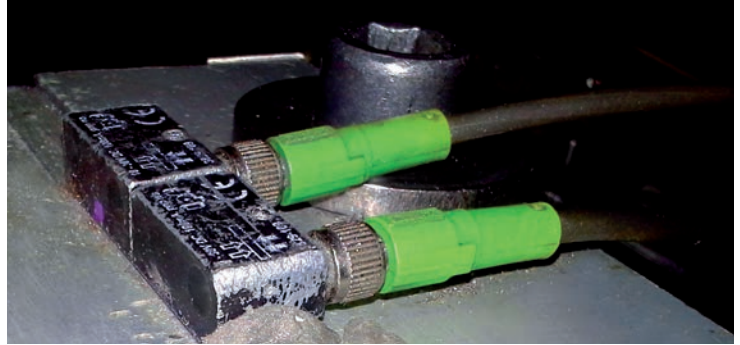

EXACT SWITCHING BEHAVIOUR IN A VERY SMALL SPACE

Two compact sensors on an extremely short pneumatic cylinder.

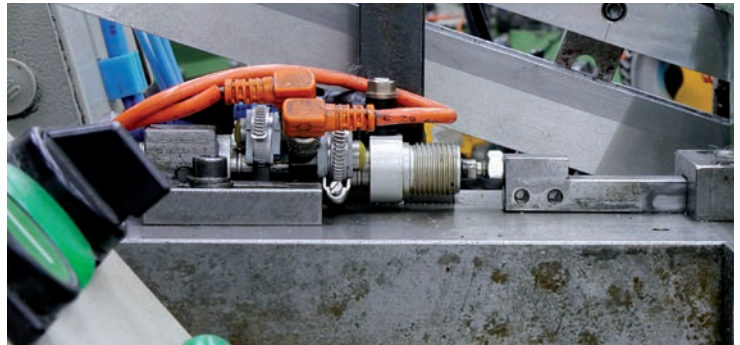

ALWAYS READY FOR USE AND RELIABLE

Even ink splashes and dried-on ink residues don't stop our sensors. They can also withstand the use of cleaning agents and solvents.



SEALED AND WEAR-FREE

Cylinder sensors on a machine in an extremely oily environment.

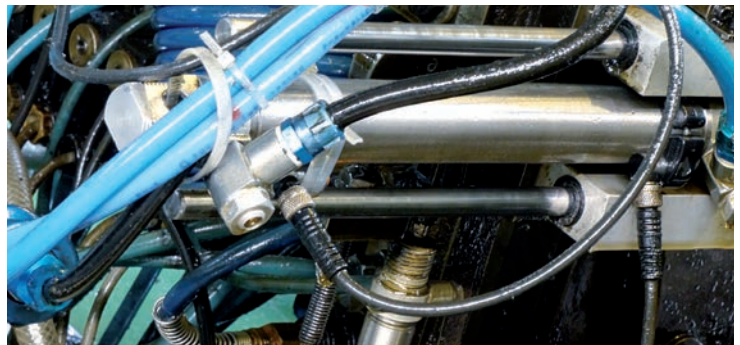

VERSATILE, VARIABLE, FLEXIBLE, ADVANCED

PRECISE POSITION DETERMINATION THAT CAN BENEFIT PRACTICAL APPLICATIONS

OUR RANGE OF OFFERINGS ARE AS DIVERSE AS THE POSSIBLE USES

ipf electronic has an immense selection of widely varying cylinder sensors with diverse fastening concepts for simple mounting on all common pneumatic cylinders to flexibly fulfill all customer wishes and requirements down to the smallest detail.

VARIABLE VARIETY

We now offer well over 200 different device types in all conceivable sizes, with additional variations, e.g., in the line length, in the design of the connections, for flush mounting or as a surface-mounted solution, with pluggable or permanently installed connection lines, and, and, and. Of course, all cables are resistant to oil and are suitable for trailing chains.

DEVELOPMENT 1: INDIVIDUAL AND UNIQUE

In addition to our devices available directly from our warehouse, we cooperate closely with our customers to develop custom cylinder sensors for very specific applications. With these individual and unique solutions, our customers receive numerous tangible benefits.

DEVELOPMENT 2: FLEXIBLE AND MODERN

The engineers at ipf electronic are also constantly working to optimize the fields of application and versatility of our cylinder sensors with respect to current and future customer requirements.

ONE FOR ALL

One example of this is our adapter concept, which facilitates the flexible fastening of a given sensor type to various pneumatic cylinders. Learn more in this brochure.

ONCE INSTEAD OF TWICE

Our teachable cylinder sensors for pneumatic short stroke cylinders are another example. With these sensors, you receive a solution that requires just a single sensor to query two piston-rod positions in applications with extremely short pneumatic cylinders. These devices are described in this brochure as well.

CYLINDER SENSORS



MZR4

for C-groove or round-groove cylinders from all leading manufacturers, high locking power, very compact design.



MZR9

for rods, pull-rods or profile cylinders from all leading manufacturers, metal housing, built-in amplifier, fastening with adapter.



MZ13

for rods, pull-rods or profile cylinders, high switching frequency, LED indicator.



MZ15

for dovetailed tenon, easy-to-install from above, independently of cylinder manufacturer.

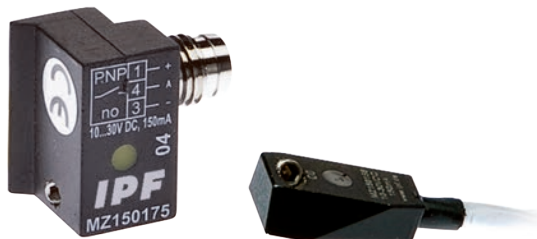

MZ07 / MZA7

for T-groove cylinders, metal housing (vibration-resistant). MZ07 and MZA7 can either be slid into the T-groove or inserted from above.



MZR4 / MZR9 / MZ13 / MZ15 / MZ07 / MZA7
CYLINDER SENSORS

ADVANTAGES AND HIGHLIGHTS

- / Versatile, for cylinders from all leading manufacturers
- / Simple mounting, simple connection
- / Precise through high switching accuracy with small hysteresis
- / Robust, housing versions in metal
- / With integrated amplifier
- / Very short travel paths
- / High temperature resistance to +130°C
- / Can also be used at very low temperatures to -40°C
- / Wear- and trouble-free and thus very long lasting
- / Impact and vibration resistant
- / Short-circuit and reverse polarity protection
- / High degree of protection IP67

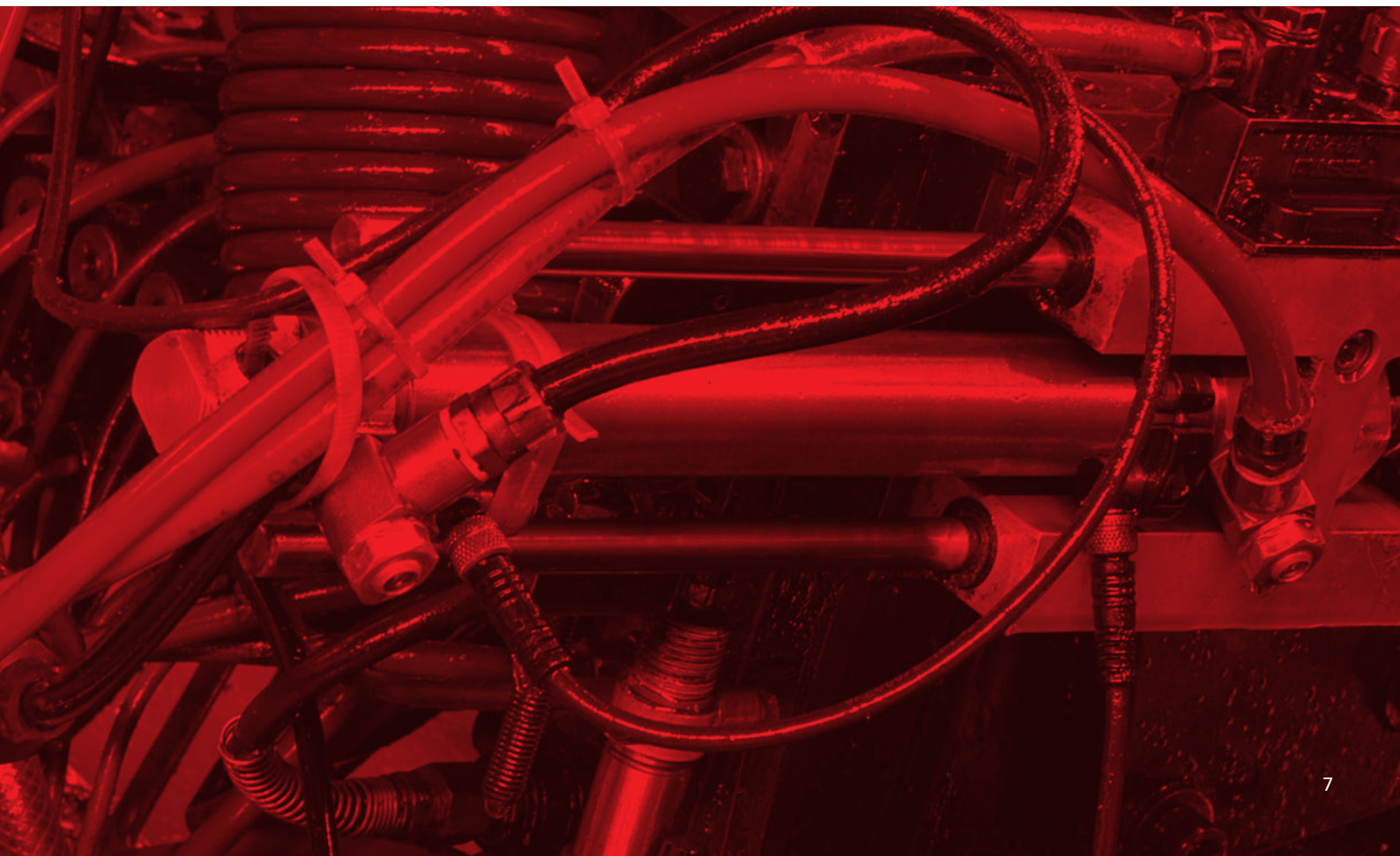

ACCESSORIES / FASTENING

ADAPTER AM000081

for T-groove cylinders



MOUNTING CLIP

AM000015

STRAP RETAINER

AM000004

for round cylinders



ADAPTER AM98A929

for cylinder CP95



MOUNTING CLIP

AM000040

for round cylinders

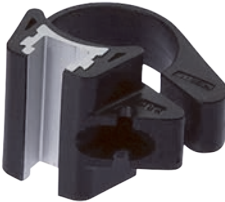

CLAMP AM000073

for profile cylinders



ADAPTER AM98A852

for cylinder ECDQ2



ADAPTER AM000036

for dovetailed cylinders



**ADAPTER / MOUNTIGN CLIPS / CLAMPS
ACCESSORIES / FASTENING**

ADVANTAGES AND HIGHLIGHTS

- / Versatile system fastening
- / Suitable for the respective cylinder types
- / Fast mounting with standard tools
- / In plastic or metal
- / Secure retention
- / Compact design

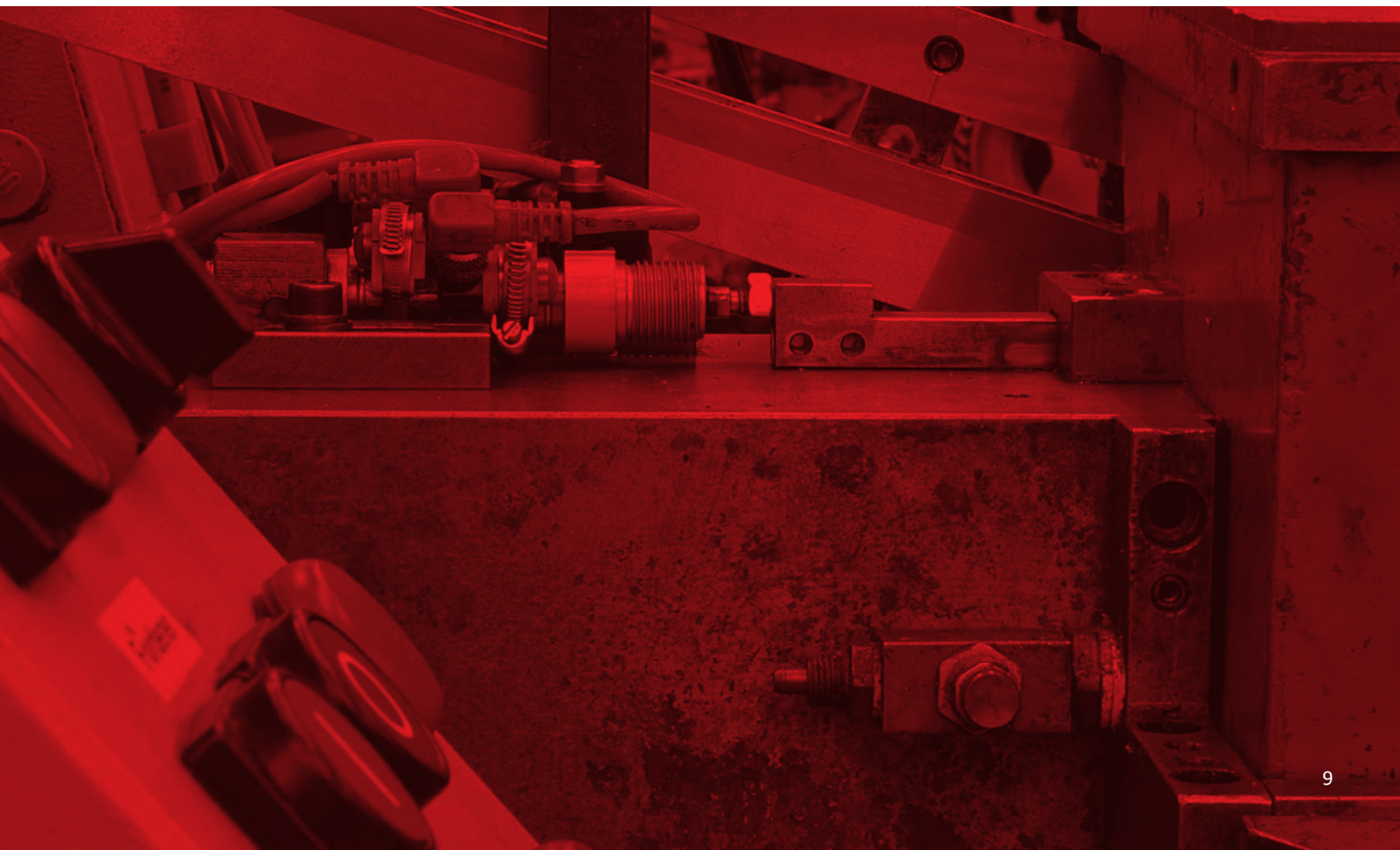



Tailor-made suits
from the rack.

THE RIGHT SENSOR FOR EVERY CYLINDER

FASTEN, CONNECT, GET TO WORK

SENSORS THAT ARE A PERFECT FIT ...

Our wide-ranging selection of cylinder sensors leaves nothing to be desired, regardless which pneumatic cylinders you use for your applications. You can also select from a variety of device variants with pluggable or permanently installed connection lines, for flush or surface mounting as well as numerous fastening concepts, which facilitate fast and trouble-free installation.

Our sensors are thus immediately ready for use and, depending on the device type, are suitable for use at temperatures from -40°C to +130°C. "Fasten, connect, get to work," is our motto. Our solutions are extremely robust and wear- and trouble-free. As a result, you can safely forget about them once installed, because they always function reliably.

THE RIGHT SENSOR FOR EVERY CYLINDER

CYLINDERS WITH C-GROOVE (ROUND GROOVE)

Pneumatic cylinders with C-groove require very compact cylinder sensors, such as our devices of the **MZR4** series. With our **MZR40787**, a device-side teach button can be used to teach two piston-rod positions with just a single sensor and output a 24V DC signal for both positions via two separate PNP outputs.

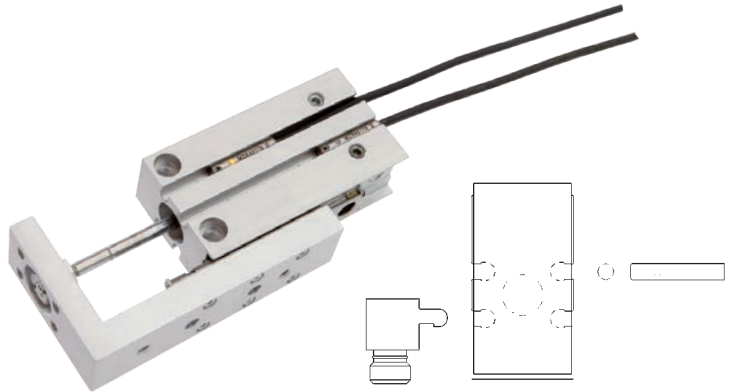

DOVETAILED CYLINDERS

Our cylinder sensors of the **MZ15** series can easily be mounted from above in the dovetailed tenon of a pneumatic cylinder. The sensors can be used completely independently of the respective cylinder manufacturer.

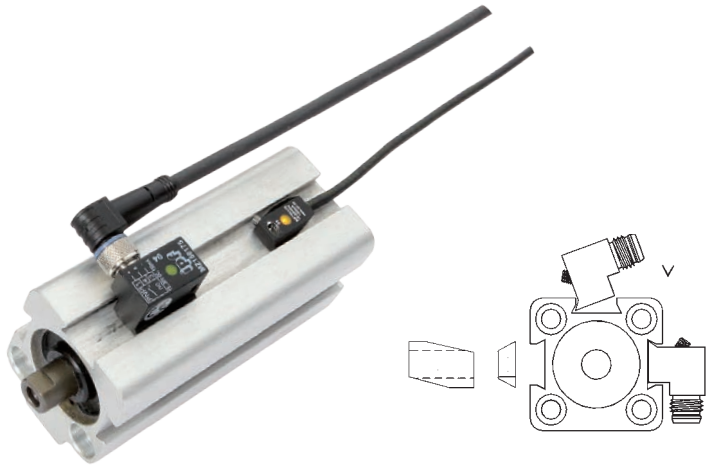

PULL-ROD CYLINDERS

Our **MZ31** sensor series was specially developed for fast mounting on pull-rod cylinders. The devices feature a built-in amplifier and, like all of our solutions, are impact- and vibration-resistant.

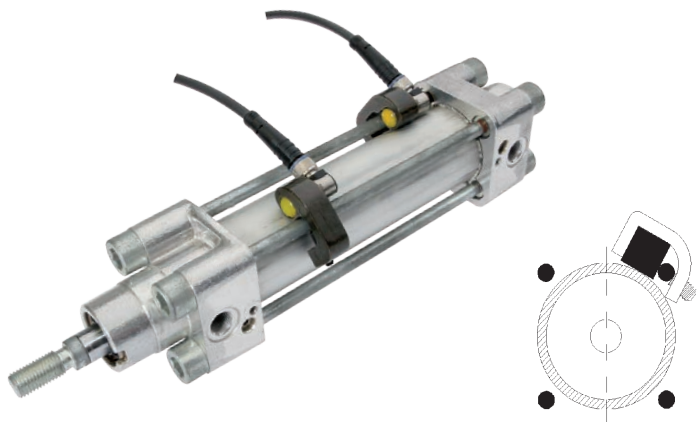



PROFILE CYLINDERS

With their robust metal housing, our sensors of the **MZR9** series, among others, can be fastened to profile and round cylinders. The devices can also be easily mounted to very short cylinders.

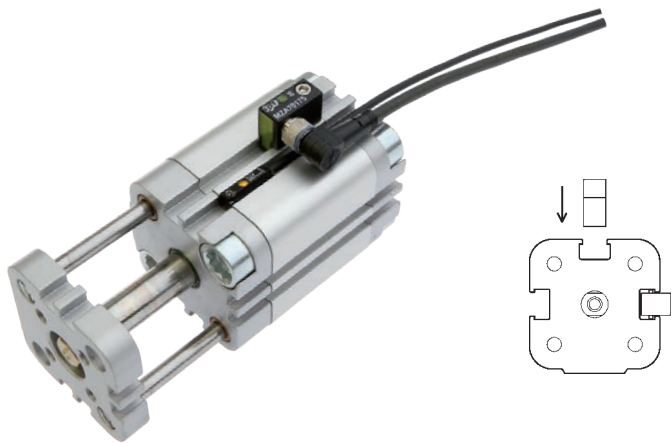

T-GROOVE CYLINDERS

Our sensors of the **MZ07** and **MZA7** series are simply slid or inserted from above into the T-groove of pneumatic cylinders. Like the **MZR40787**, our **MZ070787** features a teach button for teaching two piston-rod positions.



ROUND CYLINDERS

Developed specifically for round cylinders is our **MZ13** sensor series, which can be fastened with strap retainers. The strap retainers can be used independently of the diameter of the pneumatic cylinder.



One *for all.*

SENSOR MADE TO MEASURE

HIGH FLEXIBILITY THROUGH ADAPTERS

STAY FLEXIBLE

With our adapter concept, one sensor type can be fastened to various pneumatic cylinders, such as the **MZR4** sensor series, which is shown here as an example. This helps reduce capital commitment, as a different sensor is not needed for every cylinder, eliminating the need to keep various sensor types on hand.

Through simple mounting with standard tools, you also save time. True to the motto “one for all,” you are always flexible with this economical solution, regardless of which pneumatic cylinders you use.

SENSOR MADE TO MEASURE

C-GROOVE CYLINDERS

C-groove cylinders require no adapter for fastening to our **MZR4** sensor series.

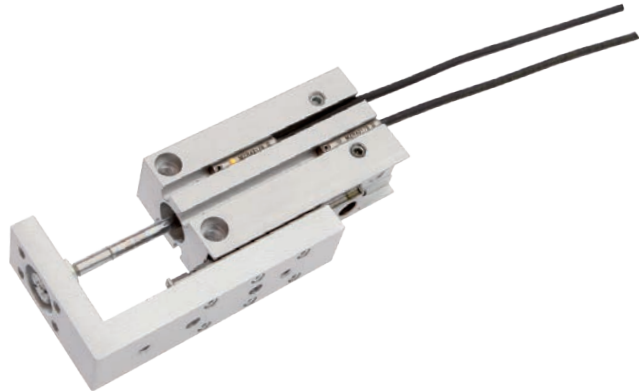

DOVETAILED CYLINDERS

with adapter **AM000081 + AM000036**

With the combination of adapters, sensors of the **MZR4** series can be fastened to dovetailed cylinders.

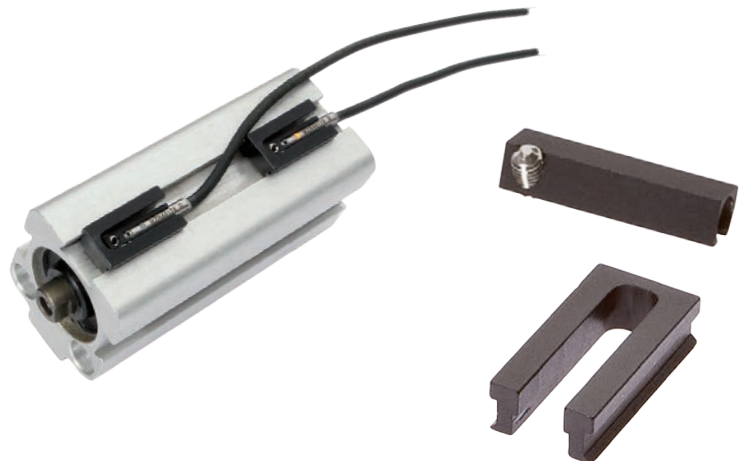

PULL-ROD CYLINDERS

with adapter **AM000081 + AM000070**

Adapters and clamps made of aluminum ensure reliable fastening of sensors of the **MZR4** series to pull-rod cylinders.





PROFILE CYLINDERS

with adapter AM000081 + AM000074

Adapters and aluminum clamp for fastening sensors of the **MZR4** series to profile cylinders.

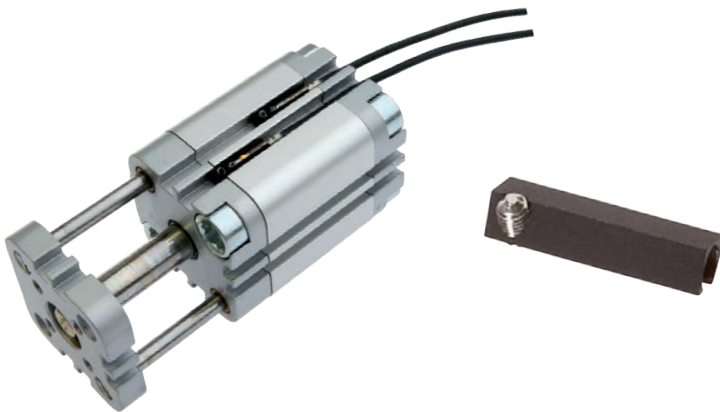

T-GROOVE CYLINDERS

with adapter AM000081

Adapters made of aluminum for mounting sensors of the **MZR4** series to cylinders with T-groove.



ROUND CYLINDERS

with adapter AM000093

Plastic clamp for fastening sensors of the **MZR4** series to round cylinders.

Customer- specific

special solutions.

10...30VDC, 100mA, pnp, no

ROEMHELD

3829-234

100°C

IPF



THE CUSTOM SPECIAL SOLUTION

UNIQUE – FOR YOUR SPECIFIC APPLICATION

DOESN'T FIT? NOT A CHANCE!

Do you have an application for which you cannot find suitable cylinder sensors in a standard design? Then speak with us. We will work closely together with you to develop a custom solution that meets the special requirements of your specific application. You benefit here from our extensive know-how and our decades of practical experience in the development of customer-specific sensors – including unique developments with which we have already overcome challenges for which there were not previously solutions.

THE CUSTOM SPECIAL SOLUTION

MZA7C879

The customer-specific sensor with special fastening concept for 6.4mm round groove was developed especially for reliable use near coupling systems with rail vehicles. The device is extremely resistant to impacts as well as vibrations and can be used in a temperature range from -40°C to +80°C.



MZ150182

This extremely robust, customer-specific solution is used on special hydraulic cylinders.

Unlike "normal" versions, these sensors have a cylinder housing made of stainless steel and an integrated position magnet. Here, the sensor must withstand very harsh operating conditions, e.g., on clamping tools for dies or interchangeable tools. Through the special fastening, the sensor always stays where it should and resists even extreme impacts as well as vibrations. This special solution can be used in temperatures from -15°C to +100°C.

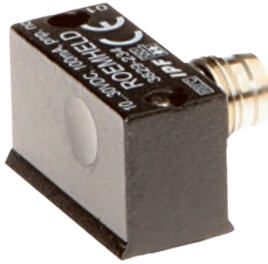

MZ07A108

A sensor solution developed for mounting on pneumatic cylinders of large systems for handling bulk, mass-produced parts, such as the cleaning and drying of workpieces made of metal. The device can withstand even the most extreme impacts and includes a special solution for fastening with a 2.5mm Allen key. Moreover, the sensor was equipped with an M12 connection at the customer's request.





MZ07C431

This special device was developed for use on a robot gripper. The fastening concept for the sensor is specially tailored to the already present pneumatic cylinder type, as are the electronics in the device, which are adapted to a non-interference-free (unclean) supply voltage. Furthermore, the solution includes a special line that is suitable for trailing chains, with a line outlet designed according to the customer's specifications.



MZ07E095

This robust sensor in metal housing with M12 plug connector is used in the immediate vicinity of a welding system. The 1m-long connection line has a Teflon sheathing to prevent damage caused by weld splatter.



MZ07E081

This sensor is used for position sensing in special gripper systems. For the mechanical integration, an especially short housing design is required. The robust metal housing ensures a long service life for the sensor, even under harsh environmental conditions.

APPLICATION EXAMPLE

PRACTICAL EXAMPLE THAT CONVINCES

PRACTICAL APPLICATIONS SHOW JUST WHAT “ROBUST” AND “LONG-LASTING” MEAN

Cylinder sensors don't have it easy in day-to-day use. In spite of high mechanical loading from impacts, vibrations, extreme oscillations, etc., the devices must always function reliably. In addition, they are often exposed to very low or very high temperatures and, particularly in the metalworking industry, they frequently come in direct contact with coolants, lubricants, emulsions and oils, to give just an overview. In order to ensure that they always function properly and over many years or decades, inks as well as cleaning agents and solvents must likewise not affect our cylinder sensors, as the following application example shows.

A company prints promotional materials, including balloons, on which images with one or more colors are printed. In order to print the desired image on both sides, the balloons are inflated in an appropriate system to a fraction of their actual volume. In the printing station, the first side of the balloon is printed with an image and then it is turned with a turning device so that the image can also be applied to the second side. For this purpose, a vacuum head is moved towards the balloon in the turning station via a pneumatic cylinder. The head applies suction to the balloon and then moves back via the pneumatic cylinder, rotates 180°, advances again via the cylinder and places the balloon back on the receiver. Because a balloon can easily explode during this “turning maneuver,” ink splashes, and thus ink deposits, are not uncommon on our cylinder sensors.

In spite of these adverse conditions, our devices with degree of protection IP67 operate trouble-free and extremely reliably over the entire production process. The system is also cleaned regularly in order to remove ink deposits, e.g., from profiles and other system components. During this process, the cylinder sensors come into direct contact with highly effective cleaning agents and solvents. Our devices remain completely undamaged by this “treatment.” With the cylinder sensors from ipf electronic, the company has found a solution for a production environment that, in several respects, meets demands on high reliability and, thus wear- and interruption-free operation. An extremely robust and long-lasting solution, in fact.



To the application report

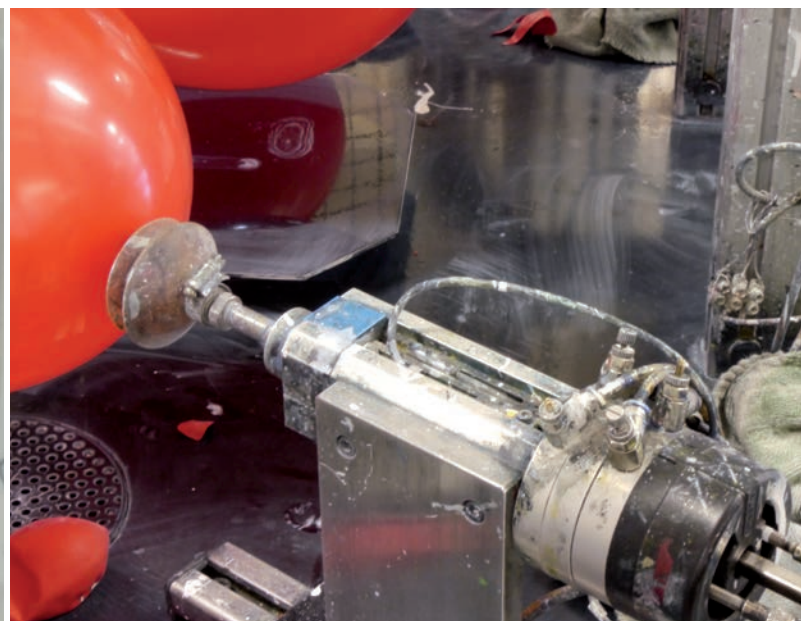
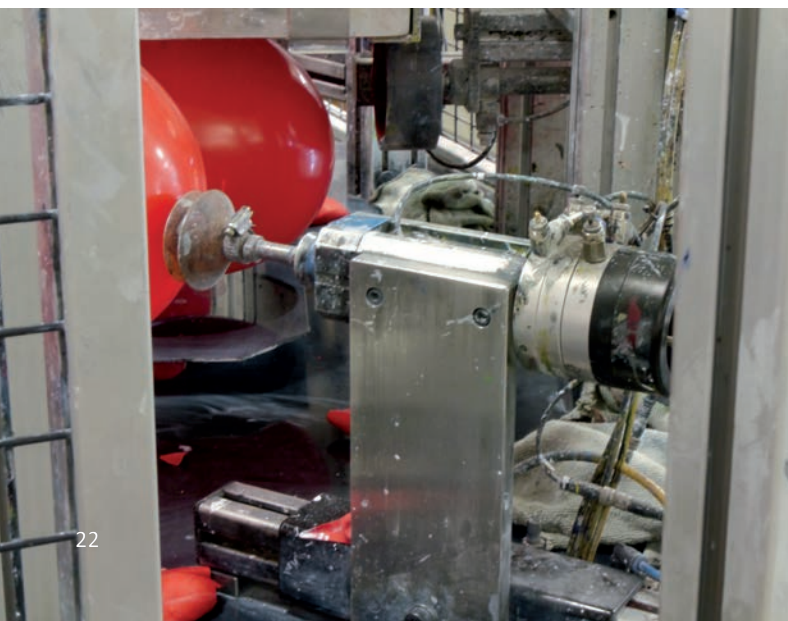

EFFICIENT CONSULTING IN ALL MATTERS

PERSONAL SERVICE AND RAPID SOLUTIONS FOR YOUR PROBLEMS

Every call is important! When you contact our technical hotline, you contact experienced employees who will answer your questions competently and conscientiously. Our goal is to provide you with comprehensive and individual advice around the clock. Our expert team of in-house trained personnel is here to support you.

In almost all industrial applications, problems are becoming ever more complex and varied. Solutions to these problems often require external expertise. You will find this expertise together with a high level of specialist and problem-solving competence at ipf electronic. We are happy to discuss tasks which may seem small with you. For us, this is a matter of course!

ipf electronic is a renowned supplier of industrial sensor technology and a reliable partner. No customer query is ignored and no on-site customer appointment is missed. Our extremely broad range of products will convince you.

Diversity, expertise, consultation and flexibility:
This is ipf electronic's recipe for success.

CONTACT

ipf electronic gmbh

Kalver Straße 25 - 27
58515 Lüdenscheid
Germany

Tel +49 2351 9365-0
Fax +49 2351 9365-19
info@ipf.de • www.ipf.de

ipf vertrieb deutschland gmbh niederlassung nord

Kirchenstraße 16
21224 Rosengarten
Germany

Tel +49 4108 4189-0
Fax +49 4108 4189-19
nord@ipf.de

ipf vertrieb deutschland gmbh niederlassung mitte

Römerweg 25
58513 Lüdenscheid
Germany

Tel +49 2351 4103-2
Fax +49 2351 9365-917
mitte@ipf.de

ipf vertrieb deutschland gmbh niederlassung süd

Flöschgasse 41
78647 Trossingen
Germany

Tel +49 7425 94005-0
Fax +49 7425 94005-19
sued@ipf.de

ipf electronic gmbh export division

Kalver Straße 25 - 27
58515 Lüdenscheid
Germany

Tel +49 2351 9365-0
Fax +49 2351 9365-19
export@ipf-electronic.com