

LT060311

FIBER OPTIC SENSORS • FIBER OPTICS GLASS FIBERS

Fiber optics in combination with the appropriate fiber optic amplifier function as contactless and wear-free position switches that can also be used in harsh environmental conditions. They detect objects independent of their characteristics (e.g., shape, color, surface structure, material). Because the ends and heads of the fiber optics have small dimensions and the fiber optics are flexible, very elegant solutions can be created for detecting objects in places that are difficult to access. Fiber optics can be used without special precautions in potentially explosive areas and in zones with electrical and/or magnetic fields (high-voltage installations, electrical welding equipment) as their function is not thereby affected. Fiber optics are available in versions for implementing the function as through-beam sensor or diffuse reflection sensor.



MECHANICAL DATA

Ambient temperature (MAX)	180 °C
Ambient temperature (MIN)	-40 °C
Bending radius (fixed)	25 mm
Bending radius (flexible)	50 mm
Degree of protection (IP)	IP67
End piece length	15 mm
Fiber diameter	6.7 mm
Fiber optics core material	Glass
Heavy soiling	Yes
Housing design	Cylinder plain
Housing material	Stainless steel
Increased ambient temperature ≤ 180°C	Yes
Material of cable sheath	Silicone
Number of fibers	1
Overall length	600 mm
Punching tools	Yes
Sensing head diameter	4 mm
Sheathing material	Stainless steel inner helix/braided glass fibers
Strong vibration / motion	Yes
Version	Push button

ELECTRICAL DATA

Analogue output 4 mA ... 20 mA	No
Bending angle of the sensing head	90 °
Light exit	Axial
Max. switching distance	60 mm
Sensing head length	37 mm

OPTICAL DATA

Range	60 mm
-------	-------

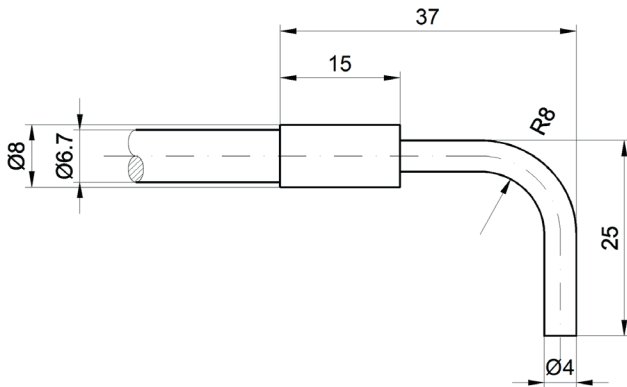
DIMENSIONAL DRAWING**INSTALLATION**

Mounting / Installation may only be carried out by a qualified electrician!

DISPOSAL**SAFETY WARNINGS**

Before initial operation, please make sure to follow all safety instructions that may be provided in the product information!

Never use these devices in applications where the safety of a person depends on their functionality.