



Valve Connectors

Industrial Connectivity Solutions



HIRSCHMANN

A **BELDEN** BRAND



lumbergautomation

A **BELDEN** BRAND



Type A

Type B

Type C

Accessories



Be certain.
Belden.



Industrial Connectivity Solutions from Belden

Founded in 1902, Belden's long-term proven solutions are in reliable operation worldwide. Our two leading brands – Hirschmann and Lumberg Automation – combine proven experience with innovation. And a focus on customer needs has made us the global leader in high-quality, end-to-end signal transmissions.

Developed with ease of use in mind, our industrial connectivity solutions are especially designed to stand up to surroundings characterized by dust, water and heavy vibrations.

Whether you want to transfer power, data, signals or all combined in the form of an intelligent I/O system, our diversified product portfolio offers you the right solution for every application.

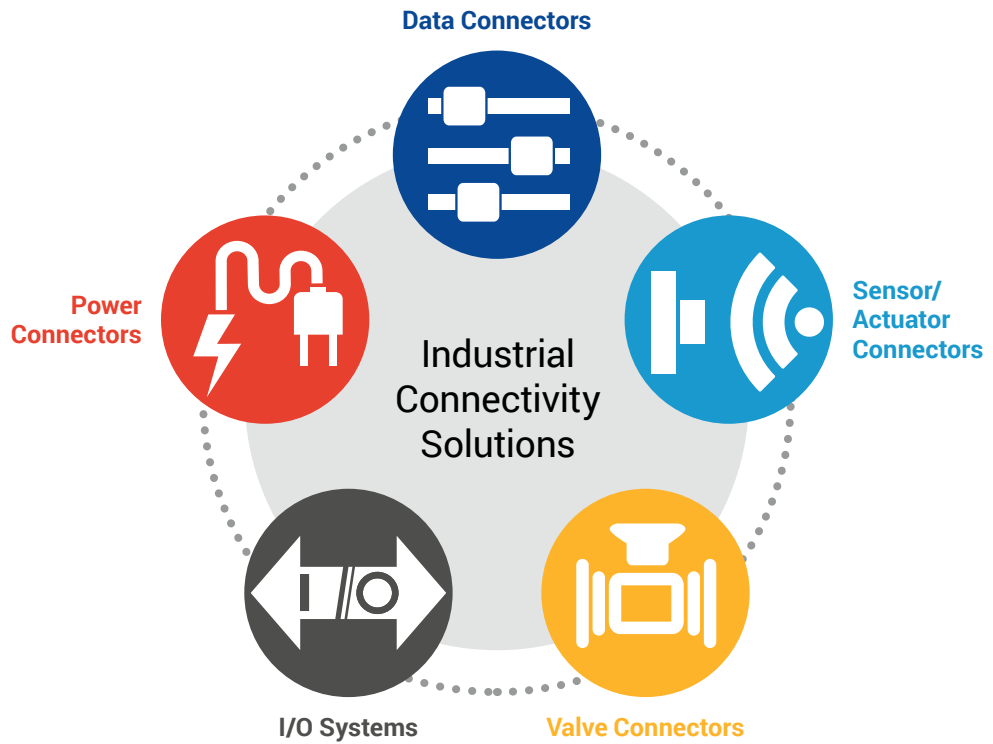



Valve Connectors

When it comes to hydraulic, pneumatic and electro-magnetic actuators and sensors, a reliable valve connector solution with high protection against dust, water and vibrations is required.

Thanks to a protection circuit and/or function indicator, as well as an extremely robust design, valve connectors from Hirschmann and Lumberg Automation reliably connect solenoid valves, pressure sensors, temperature sensors and flow monitors to voltage supplies or a data network.

Table of Contents

Industrial Connectivity Solutions	2
Valve Connectors	3
Product Overview	4–5
General Product Information	6–9
• Valve Connectors Type A	10–17
• Valve Connectors Type B	18–21
• Valve Connectors Type C	22–25
• Accessories	26–31
Our Services	32–33
Connectivity Center	34–35
Part Number Index	36–39

Two Strong Brands You Can Rely on for Decades



Product Overview

				
Products		Type A DIN Standard	Type A Flat Link Line	Type A High-Voltage Line
General Data	Standard	DIN EN 175 301-803-A ISO 4400	DIN EN 175 301-803-A ISO 4400	DIN EN 175 301-803-A ISO 4400
	Housing Color	Black, Transparent, Grey	Black, Transparent	Black, Grey
	Pin Assignment	2 + PE, 2 + 2 PE, 3 + PE		3 + PE
	Max. Operating Voltage	300 V AC/DC	230 V AC/DC	400 V AC/DC
	Max. Current	16 A	10 A	16 A
	IP-Rating	IP65, IP67, IP68, IP69 ¹⁾	IP65	IP65
Approvals	VDE	●	●	●
	UL	●		
	SEV	●		
	CSA	●		
Assembly Design	Single-Ended Cordsets	●		
	Field Attachables	●	●	●
	Receptacles	●	●	●
Circuitries	Without circuitry	●	●	●
	LED only	●	●	
	Varistor, (LED)	●	●	
	Varistor, (LED), bridge rectifier	●		
	Suppressor diode, (LED)	●	●	
	Suppressor, (LED), bridge rectifier	●		
	Recovery diode, (LED)	●	●	
	Bridge rectifier	●		
Dual LED (pressure switch)	●			
Dimensions				



					
Products		Type B DIN Standard	Type B Industry Standard	Type C DIN Standard	Type C Industry Standard
General Data	Standard	DIN EN 175 301-803-B ISO 6952	Industry Standard	DIN EN 175 301-803-C ISO 15217	Industry Standard
	Housing Color	Black, Transparent, Grey		Black, Transparent, Grey	
	Pin Assignment	2 + PE		2 + PE, 2 + 2 PE, 3 + PE	
	Max. Operating Voltage	230 V AC/DC		230 V AC/DC	
	Max. Current	16 A		6 A	
	IP-Rating	IP65, IP67 ¹⁾		IP65, IP67 ¹⁾	
Approvals²⁾	VDE	●	●	●	●
	UL	●	●	●	●
	SEV	●	●	●	●
	CSA		●	●	●
Assembly Design	Single-Ended Cordsets	●	●	●	●
	Field Attachables	●	●	●	●
	Receptacles	●	●	●	●
Circuitries	Without circuitry	●	●	●	●
	LED only	●	●	●	
	Varistor, (LED)	●	●	●	●
	Varistor, (LED), bridge rectifier	●	●		
	Suppressor diode, (LED)	●	●	●	●
	Suppressor, (LED), bridge rectifier				
	Recovery diode, (LED)	●	●		
	Bridge rectifier				
Dual LED (pressure switch)					
Dimensions					

1) Molded version only

2) Please review product chapters for more details

Cable Material Comparison

Material	High Temp	Low Temp	Flexibility	UV-Rays	Chemicals	Oil
PUR	●●●●	●●●○	●●●○	●●●○	●●●●	●●●○
PVC	●●○○	●●○○	●●○○	●●○○	●●○○	●●○○

●○○○ = Poor ●●○○ = Fair ●●●○ = Good ●●●● = Excellent

Please request data sheet for more detailed information

Control Cable Overview

Control Cable	Conductor Size	Cable Material	Jacket Color	Temperature Range Stationary / Flexible	Cable Diameter	Bend Radius Stationary / Flexible	Bending Cycles	Cable Characteristics
017	3G0.50mm ²	PVC	Black	-40 °C to +70 °C 5 °C to +70 °C	ø 5.0 mm	> 5 x D > 10 x D	-	
205	3G0.75mm ²	PVC	Black	-40 °C to +70 °C 5 °C to +70 °C	ø 5.50 mm	> 5 x D > 10 x D	-	
212	3G0.50mm ²	PVC	Black	-40 °C to +70 °C -5 °C to +70 °C	ø 5.0 mm	> 5 x D > 10 x D	-	
226	3G0.50mm ²	PUR	Black	-50 °C to +105 °C -25 °C to +105 °C	ø 4.6 mm	> 5 x D > 10 x D	> 5 Mio	
228	5G0.50mm ²	PUR	Black	-50 °C to +105 °C -25 °C to +80 °C	ø 5.4 mm	> 5 x D > 10 x D	> 5 Mio	
603	3G0.75mm ²	PUR	Grey	-40 °C to +90 °C -20 °C to +90 °C	ø 5.80 mm	> 5 x D > 7.5 x D	-	
604	4G0.75mm ²	PUR	Grey	-40 °C to +90 °C -20 °C to +90 °C	ø 6.50 mm	> 4 x D > 7.5 x D	> 5 Mio	
606	2x0.75mm ²	PUR	Grey	-40 °C to +90 °C -20 °C to +90 °C	ø 5.50 mm	> 4 x D > 7.5 x D	-	
609	3G0.75mm ²	PVC	Grey	-40 °C to +105 °C 5 °C to +105 °C	ø 5.5 mm	> 5 x D > 10 x D	-	
610	4G0.75mm ²	PVC	Grey	-40 °C to +90 °C -5 °C to +90 °C	ø 6.2 mm	> 5 x D > 10 x D	-	
611	5G0.75mm ²	PVC	Grey	-40 °C to +90 °C -5 °C to +90 °C	ø 6.8 mm	> 4 x D > 10 x D	-	
618	2x0.75mm ²	PVC	Grey	-40 °C to +90 °C -5 °C to +90 °C	ø 5.5 mm	> 4 x D > 7.5 x D	-	
744	4G0.50mm ²	PUR	Black	-40 °C to +80 °C -5 °C to +80 °C	ø 4.8 mm	> 5 x D > 10 x D	-	
743	4G0.50mm ²	PVC	Black	-40 °C to +80 °C -5 °C to +80 °C	ø 5.3 mm	> 5 x D > 10 x D	-	

Vibration and shock resistance
 UL-approved
 UV resistance
 Oil, coolants, lubricants and emulsion resistance
 Drag chain suitability
 Welding sparks resistance



Protection Circuitries

	Circuit Diagram	Circuitry Description	Operating Voltage	Rated Current	Combination with LED	Combination with Bridge Rectifier	Combination with LED and Bridge Rectifier
Indication							
		Bipolar LED function indication for applications with direct and alternating current	24, 48, 110, 230 V AC/DC	10 A	-		
		LED status indicator in combination with three switching contacts for pressure switch applications	24, 230 V AC/DC	10 A	-	-	-
Protection							
		Varistor, voltage-dependent resistor, for the absorption of inductive voltage spikes	24, 48, 110, 230 V AC/DC	10 A			
		Bidirectional suppressor diode (TVS) with fast response time protecting from critical overvoltage	24 V AC/DC	10 A			
		Recovery diode reducing voltage fly back in direct current applications	24-230 V AC/DC	10 A		-	-
Rectification							
		Bridge rectifier reversing alternating current into direct current	24-230 V AC/DC	1 A		-	
		Combination of bridge rectifier, varistor and capacitor for direct current applications protecting from surge with simultaneous signal smoothing	230 V	1 A		-	

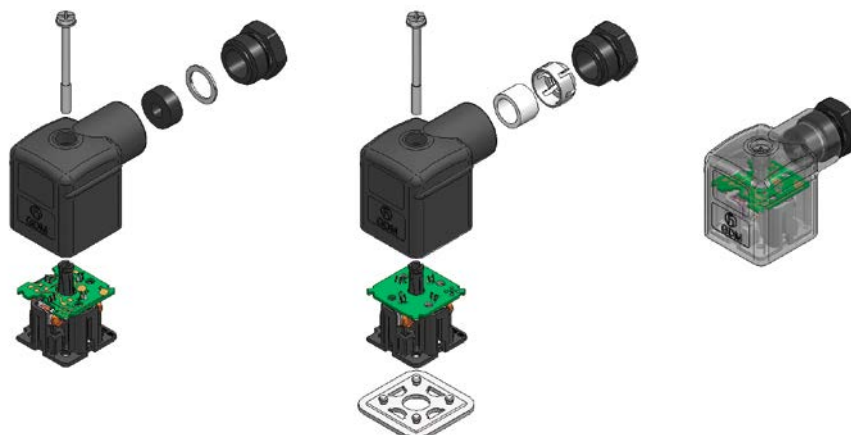

Gasket Material Comparison

Material	High Temp	Low Temp	UV & Ozone	Oil	Chemicals
NBR	●●○	●●○	●○○	●●●	●●○
EPDM	●●●	●●○	●●●	●○○	●●○
FKM	●●●	●○○	●●●	●●●	●●●
MPQ	●●●	●●●	●●●	●●●	●●●

○○○ = Not recommended ●○○ = Limited resistance ●●○ = Good resistance ●●● = Excellent resistance

Please request data sheet for more detailed information





IP Code

Index		Degree of Protection
0		No protection against accidental contact, no protection against solid foreign bodies
1		Protection against contact with any large area by hand and against solid foreign bodies with $\varnothing >50$ mm
2		Protection against contact with the fingers, protection against solid foreign bodies with $\varnothing >12$ mm
3		Protection against tools, wires or similar objects with $\varnothing >2.5$ mm, protection against solid foreign bodies with $\varnothing >2.5$ mm
4		Just like 3 except for the size difference of $\varnothing >1$ mm
5		Full protection against contact, protection against interior injurious dust deposits
6		Total protection against contact, protection against penetration of dust

Index		Degree of Protection
0		No protection against water
1		Protection against vertical water drops
2		Protection against water drops (up to a 15° angle)
3		Protection against diagonal water drops (up to a 60° angle)
4		Protection against splashed water from all directions
5		Protection against water (out of a nozzle) from all directions
6		Protection against water penetration during temporary flooding
7		Protection against temporary submersion in water
8		Protection against permanent submersion in water
9K		Protection against water from high-pressure/steam jet cleaners



Valve Connectors Type A

Build to Last, No Matter Where Your Applications
Take You

With hydraulic, pneumatic and electromagnetic actuators and sensors, the GDM and GAN series stands ready for any harsh environment. Rugged, highly impermeable design guarantees uncompromising reliability in the most demanding applications.



The Benefits

Long-lasting performance – state-of-the-art housing singularly engineered for mechanical challenges and vibrations, optionally with strain relief and UL2238 approval

Outstanding reliability – high IP67 and IP69 impermeability combined with an extraordinary resistance towards environmental impacts, oils and lubricants

Unmatched flexibility – choose from numerous configurations to match your individual application challenges

Markets

- Manufacturing Automation
- Machine Building
- Mobile Machinery
- Material Handling
- Transportation
- Process Automation

Technical Information

Type A Field Attachables	GDM Standard	GDM with cURus	GDMF Flat Line	GDMW High-Voltage Line
	General Data			
Standard	DIN EN 175301-803-A ISO 4400	DIN EN 175301-803-A ISO 4400	DIN EN 175301-803-A ISO 4400	DIN EN 175301-803-A ISO 4400
Housing Color	Black, Transparent, Grey	Black	Black, Transparent	Black, Grey
No. of Pins	2 + PE, 3 + PE	2 + PE, 3 + PE	2 + PE, 3 + PE	3 + PE
Cable Range	M16 & PG9: Ø 4.5 - 10 mm M20 & PG11: Ø 4.5 - 11 mm 1/2" NPTF: Ø 8 - 13.5 mm G1/2" (ISO 228): Ø 8 - 13 mm	M16 & PG9: Ø 6 - 8 mm M20 & PG11: Ø 8 - 10 mm 1/2" NPTF: Ø 8 - 10 mm G1/2" (ISO 228): Ø 8 - 10 mm	M16: Ø 4 - 8 mm	PG11: Ø 4.5 - 11 mm
Terminal Type	Screw	Screw	Screw	Screw
Conductor Size	0.25 - 1.5 mm ²	0.25 - 1.5 mm ²	0.34 - 1.5 mm ² 0.34 - 0.75 mm ² (with circuitry)	0.25 - 1.5 mm ²
Strain Relief	-	Clamping Cage	-	-
	Electrical Data			
Operating Voltage¹⁾	230 V AC/DC	300 V AC/DC	230 V AC/DC	400 V AC/DC
Current¹⁾	16 A	10 A	10 A	16 A
	Environmental Data			
Ambient Temperature²⁾	Black: -40°C to +125°C Transparent: -25°C to +90°C	-40°C to +125°C	Black: -40°C to +125°C Transparent: -25°C to +90°C	-40°C to +125°C
Protection Degree	IP65	IP65, IP67	IP65	IP65
Approvals	VDE, SEV	VDE, SEV, cURus (UL2238)	VDE	CSA, UL (1977)

1) In combination with circuitries values may deviate. Please review data sheet for more information.

2) Notice derating





Product Configurator

Type A Field Attachables

G D M 21 0 6 - A 0 U - 1 0 F

Design

GDM = Type A, female connector, field attachable

Pin Assignment

21 = 2 + PE

31 = 3 + PE

Housing

0 = Black

A = Black (cURus)

F = Transparent

6 = Grey

Cable Gland

6 = M16

A = M20

9 = PG9

B = PG11

D = 1/2" NPTF

E = G1/2" (ISO 228)

J = M16 with strain relief (cURus)

M = M20 with strain relief (cURus)

L = PG9 with strain relief (cURus)

N = PG11 with strain relief (cURus)

Q = 1/2" NPTF with strain relief (cURus)

R = G1/2" (ISO 228) with strain relief (cURus)

Circuitry

Protection circuitry

A0 = No circuitry

V1 = Varistor

S1 = Suppressor diode

D1 = Recovery diode

With bridge rectifier

V3 = Varistor, bridge rectifier

S3 = Suppressor diode, bridge rectifier

D3 = Bridge rectifier only

C3 = Varistor, bridge rectifier, capacitor

With LED

L1 = LED only

V2 = Varistor, LED

S2 = Suppressor diode, LED

D2 = Recovery diode, LED

P1 = Dual LED (pressure switch)

With bridge rectifier and LED

V4 = Varistor, bridge rectifier, LED

S4 = Suppressor diode, bridge rectifier, LED

D4 = Bridge rectifier, LED

C4 = Varistor, bridge rectifier, capacitor, LED

Voltage

Without LED

Q = 24 V

K = 48 V

S = 110 V

U = 230 V

With LED (yellow)

4 = 24 V

8 = 48 V

1 = 110 V

Y = 230 V

With dual LED (red and green)

J = 24 V (pressure switch)

N = 230 V (pressure switch)

@ Further circuitries and LED colors upon request, please contact us at: icos-sales@belden.com

Central Screw

1 = Steel, Phillips combi slot

2 = Steel, torx head

3 = Steel, knurled head

4 = Stainless steel, Phillips combi slot

Gasket

Flat Gasket

A = NBR

B = EPDM

C = FKM

D = MPQ

Profile Gasket

E = NBR

F = EPDM

H = MPQ

Captive Gasket

K = NBR

L = EPDM

0 = Without gasket

Packaging

F = Collect packaging, 200 pieces (versions without circuitry)

D = Collect packaging, 50 pieces (versions with circuitry only)

P = Single packaging, 200 pieces (versions without circuitry)

M = Single packaging, 50 pieces (versions with circuitry only)

Order Overview – Exemplary Configurations

Type A Field Attachables	24 V	48 V	110 V	230 V
<p>1. Choose Max. Voltage →</p> <p>2. Choose Design ↓</p>				
GDM Black Standard				
2 + PE, without circuitry, M16	–	–	–	GDM2106-A0U-10F
2 + PE, with varistor, M16	GDM2106-V1Q-10D	GDM2106-V1K-10D	GDM2106-V1S-10D	GDM2106-V1U-10D
2 + PE, with varistor and bridge rectifier, M16	GDM2106-V3Q-10D	GDM2106-V3K-10D	GDM2106-V3S-10D	GDM2106-V3U-10D
2 + PE, with suppressor diode, M16	GDM2106-S1Q-10D	–	–	–
2 + PE, with suppressor diode and bridge rectifier, M16	GDM2106-S3Q-10D	–	–	–
2 + PE, with recovery diode, M16	–	–	–	GDM2106-D1U-10D
2 + PE, with bridge rectifier, M16	–	–	–	GDM2106-D3U-10D
GDM Transparent Standard				
2 + PE, with LED, M16	GDM21F6-L14-10D	GDM21F6-L18-10D	GDM21F6-L11-10D	GDM21F6-L1Y-10D
2 + PE, with LED and bridge rectifier, M16	GDM21F6-D44-10D	GDM21F6-D48-10D	GDM21F6-D41-10D	GDM21F6-D4Y-10D
2 + PE, with LED and varistor, M16	GDM21F6-V24-10D	GDM21F6-V28-10D	GDM21F6-V21-10D	GDM21F6-V2Y-10D
2 + PE, with LED, varistor and bridge rectifier, M16	GDM21F6-V44-10D	GDM21F6-V48-10D	GDM21F6-V41-10D	GDM21F6-V4Y-10D
2 + PE, with LED and suppressor diode, M16	GDM21F6-S24-10D	–	–	–
2 + PE, with LED, suppressor diode and bridge rectifier, M16	GDM21F6-S44-10D	–	–	–
2 + PE, with LED and recovery diode, M16	GDM21F6-D24-10D	GDM21F6-D28-10D	GDM21F6-D21-10D	GDM21F6-D2Y-10D
GDM Black with cURus				
2 + PE, without circuitry, M16 with strain relief	–	–	–	GDM21AJ-A0U-10F
2 + PE, with bridge rectifier, M16 with strain relief	–	–	–	GDM21AJ-D3U-10D
2 + PE, with varistor, M16 with strain relief	GDM21AJ-V1Q-10D	GDM21AJ-V1K-10D	GDM21AJ-V1S-10D	GDM21AJ-V1U-10D
2 + PE, with varistor and bridge rectifier, M16 with strain relief	GDM21AJ-V3Q-10D	GDM21AJ-V3K-10D	GDM21AJ-V3S-10D	GDM21AJ-V3U-10D
2 + PE, with recovery diode, M16 with strain relief	–	–	–	GDM21AJ-D1U-10D
GDMF				
2 + PE, without circuitry, M16, flat line	–	–	–	GDMF 2016 DAAA
2 + PE, with LED, M16, flat line	GDMF 2016 DBAA	–	GDMF 2016 DCAA	GDMF 2016 DEAA
2 + PE, with LED and varistor, M16, flat line	–	–	GDMF 2016 DRAA	GDMF 2016 DLAA
2 + PE, with LED and recovery diode, M16	GDMF 2016 DGAA	–	–	–
2 + PE, with LED and suppressor diode, M16, flat line	GDMF 2016 DFAA	–	–	–
GDMW				
3 + PE, without circuitry, PG11, black housing	–	–	–	GDMW 3011 DF black
3 + PE, without circuitry, PG11, grey housing	–	–	–	GDMW 3011 DF grey

These articles are exemplary configurations. Please use our configurator on page 12 for more options.



Technical Information

Type A Receptacles	GSA / GSC	GSE	GSP	GSR
General Data				
Standard	DIN EN 175301-803-A ISO 4400	DIN EN 175301-803-A ISO 4400	DIN EN 175301-803-A ISO 4400	DIN EN 175301-803-A ISO 4400
No. of Pins	2 + PE, 3 + PE	2 + PE, 3 + PE	2 + PE, 3 + PE	2 + PE, 3 + PE
Conductor Size	Max. 1.5 mm ²	Max. 1.5 mm ²	Max. 1.5 mm ²	Max. 1.5 mm ²
Terminal Type	Solder (GSA), PE to screw Crimp (GSC), PE to screw	Solder, PE to screw	Solder, PE to screw	Solder
Installation	Screw	Screw	Thread	Overmolding
Electrical Data				
Operating Voltage	400 V AC/DC	400 V AC/DC	400 V AC/DC	400 V AC/230 V DC
Current	16 A	16 A	16 A	16 A
Environmental Data				
Ambient Temperature¹⁾	-40 °C to +125 °C	-40 °C to +125 °C	-40 °C to +125 °C	-40 °C to +125 °C
Protection Degree	IP65 IP67 (GSA-U)	IP65	IP65	IP65
Approvals	UL, VDE, SEV, CSA	UL, VDE, SEV, CSA	VDE, SEV	VDE

1) Notice derating

Order Overview

Type A Receptacles	2 + PE	3 + PE
<p>1. Choose Coding →</p> <p>2. Choose Design ↓</p>		
Rectangular, with oblong holes for optional front soldering	GSA 2000	GSA 3000
Rectangular, without oblong holes, solder contacts	GSA 2000 N	GSA 3000
Rectangular, crimp contacts	–	GSC 3000
Rectangular, for cylinder installation, solder contacts	GSAZ 200	GSAZ 300
Rectangular, molded, solder contacts	GSA-U 2000 N LO	GSA-U 3000 N LO
Rectangular, without oblong holes, round collar, solder contacts	GSE 2000 N4	GSE 3000 N4
Circular, solder contacts	GSR-U 2000 LO	GSR-U 3000 LO
Circular, with connection thread, solder contacts	GSP 211 PG11 GSP 212 1/2" NPTF Further threads upon request	GSP 311 PG11 GSP 312 1/2" NPTF Further threads upon request

Technical Information

Type A Molded	GAN	GAN with cULus approval
General Data		
Standard	DIN EN 175301-803-A, ISO 4400	DIN EN 175301-803-A, ISO 4400
Housing Color	Grey translucent	Black
No. of Pins	2 + PE, 2 + 2 PE, 3 + PE, 2-poles, 3-poles	
Cable Material	PUR, PVC	PUR, PVC
Conductor Size	0.5 mm ² , 0.75 mm ²	0.5 mm ² , 0.75 mm ²
Electrical Data		
Operating Voltage¹⁾	230 V AC/DC	230 V AC/DC
Current¹⁾	10 A (0.75 mm ²)/6 A (0.5 mm ²)	6 A (0.75 mm ²)/4 A (0.5 mm ²)
Environmental Data		
Ambient Temperature²⁾	-25 °C to +85 °C -40 °C to +105 °C, with add-on gasket	-25 °C to +85 °C -40 °C to +105 °C, with add-on gasket
IP-Rating	IP65, IP67, IP68, IP69 (with PUR cable)	IP65, IP67, IP68, IP69 (with PUR cable)
Approvals	VDE, SEV	VDE, SEV, cULus (UL2238)

1) In combination with protection circuitries values may deviate. Please review data sheet for more information.

2) Notice derating





Product Configurator

Type A Cordsets

G A N 2 2 L U - A 0 U - 6 0 3 0 2 0 0 - 1 U C

Design

GAN = Type A, female cordset, molded

Pin Assignment

20 = 2-poles(without PE) 30 = 3-poles(without PE)
21 = 2 + PE (PE across cable outlet) 31 = 3 + PE (PE across cable outlet)
22 = 2 + 2 PE 3Z = 3 + PE (PE at cable outlet)

Housing

LU = Grey translucent, molded 0U = Black, molded

Protection Circuitry

Circuitry

A0 = No Circuitry
V1 = Varistor
S1 = Suppressor diode
D1 = Recovery diode

With bridge rectifier

V3 = Varistor, bridge rectifier
S3 = Suppressor diode, bridge rectifier
D3 = Bridge rectifier only
C3 = Varistor, bridge rectifier, capacitor

With LED

L1 = LED only
V2 = Varistor, LED
S2 = Suppressor diode, LED
D2 = Recovery diode, LED
P1 = Dual LED (pressure switch)

With bridge rectifier and LED

V4 = Varistor, bridge rectifier, LED
S4 = Suppressor diode, bridge rectifier, LED
D4 = Bridge rectifier, LED
C4 = Varistor, bridge rectifier, capacitor, LED

Voltage

Without LED

Q = 24 V
K = 48 V
S = 110 V
U = 230 V

With LED (yellow)

4 = 24 V
8 = 48 V
1 = 110 V
Y = 230 V

With dual LED (red, green)

J = 24 V (pressure switch)
N = 230 V (pressure switch)

Control Cable

PVC

212 = PVC 3G0.50 mm², Black
205 = PVC 3G0.75 mm², Black
609 = PVC 3G0.75 mm², Grey
743 = PVC 4G0.50 mm², Black
610 = PVC 4G0.75 mm², Grey
611 = PVC 5G0.75 mm², Grey
618 = PVC 2X0.75 mm², Grey

PUR

226 = PUR 3G0.50 mm², Black
603 = PUR 3G0.75 mm², Grey
744 = PUR 4G0.50 mm², Black
604 = PUR 4G0.75 mm², Grey
606 = PUR 2X0.75 mm², Grey
228 = PUR 5G0.5 mm², Black

X: Without PE
G: With PE

@ Haven't yet found the cable or length you need? Please contact us at: icos-sales@belden.com

Length

0200 = 2 meter 0500 = 5 meter 1000 = 10 meter

Central Screw

1 = Steel, Phillips combi slot 4 = Stainless steel, Phillips combi slot

Gasket

U = Molded-on gasket Q = EPDM add-on gasket

Packaging

A - G = Collect packaging (5 - 200 units depending on length of control cable)
H - P = Single packaging (5 - 200 units depending on length of control cable)

Order Overview – Exemplary Configurations

Type A Cordsets	24 V	48 V	110 V	230 V
<p>1. Choose Max. Voltage →</p> <p>↓ 2. Choose Design</p>				
2 + 2 PE without circuitry, PUR	–	–	–	GAN22LU-A0U-6030200-1UC
2 + 2 PE with LED, PUR	GAN22LU-L14-6030200-1UC	GAN22LU-L18-6030200-1UC	GAN22LU-L11-6030200-1UC	GAN22LU-L1Y-6030200-1UC
2 + 2 PE with varistor, PUR	GAN22LU-V1Q-66030200-1UC	GAN22LU-V1K-6030200-1UC	GAN22LU-V1S-6030200-1UC	GAN22LU-V1U-6030200-1UC
2 + 2 PE with varistor and LED, PUR	GAN22LU-V24-66030200-1UC	GAN22LU-V28-6030200-1UC	GAN22LU-V21-6030200-1UC	GAN22LU-V2Y-6030200-1UC
2 + PE with varistor and bridge rectifier, PUR	GAN21LU-V3Q-66030200-1UC	GAN21LU-V3K-6030200-1UC	GAN21LU-V3S-6030200-1UC	GAN21LU-V3U-66030200-1UC
2 + PE with varistor, bridge rectifier and LED, PUR	GAN21LU-V44-6030200-1UC	GAN21LU-V48-6030200-1UC	GAN21LU-V41-6030200-1UC	GAN21LU-V4Y-6030200-1UC
2 + 2 PE with suppressor diode, PUR	GAN22LU-S1Q-6030200-1UC	–	–	–
2 + 2 PE with suppressor diode and LED, PUR	GAN22LU-S24-6030200-1UC	–	–	–
2 + PE with suppressor diode and bridge rectifier, PUR	GAN21LU-S3Q-6030200-1UC	–	–	–
2 + PE with suppressor diode, bridge rectifier and LED, PUR	GAN21LU-S44-6030200-1UC	–	–	–
2 + 2 PE with recovery diode, PUR	–	–	–	GAN22LU-D1U-6030200-1UC
2 + 2 PE with recovery diode and LED, PUR	GAN22LU-D24-6030200-1UC	GAN22LU-D28-6030200-1UC	GAN22LU-D21-6 030200-1UC	GAN22LU-D2Y-6030200-1UC
2 + PE with bridge rectifier, PUR	–	–	–	GAN21LU-D3U-6030200-1UC
2 + PE with bridge rectifier and LED, PUR	GAN21LU-D44-6030200-1UC	GAN21LU-D48-6030200-1UC	GAN21LU-D41-6030200-1UC	GAN21LU-D4Y-6030200-1UC

These articles are exemplary configurations. Please use our configurator on page 16 for more options.





Valve Connectors Type B

Dependable Technology, Perfect Connection

Intuitive handling combined with a particularly durable design makes the proven type B valve connectors the ideal choice for challenging industrial automation surroundings.



The Benefits

Easy to connect – with plug-and-play, prewired cordsets or flexible field attachables, user-friendly

Easy to maintain – protective circuitries combined with all-around clearly visible LED function displays facilitate quick optical controls and ease of maintenance

Easy to rely on – ideal for harsh applications due to an extended temperature range, high impermeability and a vibration-proof design

Markets

- Manufacturing Automation
- Machine Building
- Mobile Machinery
- Material Handling
- Transportation
- Process Automation

Technical Information



Type B	GMN(L)/GM(L) ...	VB/VBD	GSN/GSA ...
	General Data		
Standard	DIN EN 175301-803-B/ Industry Standard	DIN EN 175301-803-B/ Industry Standard	DIN EN 175301-803-B/ Industry Standard
Assembly Design	Field attachables	Cordsets	Receptacles
Housing Color	Black, Transparent, Grey	Black, Translucent	Black
No. of Pins	2 + PE	2 + PE	2 + PE
Cable Range	M16/PG 9: Ø 4.5 - 7 mm	–	–
Terminal Type	Screw	–	Solder
Conductor Size	Max. 1.5 mm ²	0.5 mm ² , 0.75 mm ²	Max. 1.5 mm ²
Cable Material	–	PUR, PVC	–
	Electrical Data		
Operating Voltage¹⁾	230 V AC/DC	230 V AC/DC	230 V AC/DC
Current¹⁾	16 A	4 A (0.5 mm ²)/10 A (0.75 mm ²)	16 A
	Environmental Data		
Ambient Temperature²⁾	Black: -40 °C to +125 °C Transparent: -40 °C to +90 °C	-25 °C to +80 °C	-40 °C to +125 °C
Protection Degree	IP65	IP65	IP65
Approvals	VDE, UL, CSA (GM only)	–	VDE, SEV, UL

1) In combination with circuitries values may deviate. Please review data sheet for more information.

2) Notice derating



Order Overview – Exemplary Configurations

Type B	DIN Standard	Industry Standard
<p style="text-align: center;">1. Choose Standard →</p> <p style="text-align: center;">↓ 2. Choose Design</p>		
Field Attachables		
2 + PE, without circuitry (230 V), PG9	GMN 209 NJ black	GM 209 NJ black
2 + PE, PG 9 with LED (24 V), PG9	GMNL 209 NJ LED 24 YE black	GML 209 NJ LED 24 YE black
2 + PE, PG 9 with LED (110 V), PG9	GMNL 209 NJ LED 120 YE black	GML 209 NJ LED 120 YE black
2 + PE, PG 9 with LED (230 V) PG9	GMNL 209 NJ LED 230 YE black	GML 209 NJ LED 230 YE black
2 + PE with recovery diode and LED (24 V), PG9	GMNL 209 NJ LED 24 HH black	GML 209 NJ LED 24 HH black
2 + PE with recovery diode and LED (110 V), PG9	GMNL 209 NJ LED 120 HH black	GML 209 NJ LED 120 HH black
2 + PE with recovery diode and LED (230 V), PG9	GMNL 209 NJ LED 230 HH black	GML 209 NJ LED 230 HH black
2 + PE with varistor and bridge rectifier (230 V), PG9	GMNL 209 NJ GB1 black	GML 209 NJ GB1 black
2 + PE with varistor, bridge rectifier and LED (24 V), PG9	GMNL 209 NJ GB1 LED 24 black	GML 209 NJ GB1 LED 24 black
2 + PE with varistor, bridge rectifier and LED (110 V), PG9	GMNL 209 NJ GB1 LED 120 black	GML 209 NJ GB1 LED 120 black
2 + PE with varistor, bridge rectifier and LED (230 V), PG9	GMNL 209 NJ GB1 LED 230 black	GML 209 NJ GB1 LED 230 black
2 + PE with varistor and LED (24 V), PG9	GMNL 209 NJ LED 24 VR YE black	GML 209 NJ LED 24 VR YE black
2 + PE with varistor and LED (110 V), PG9	GMNL 209 NJ LED 120 VR YE black	GML 209 NJ LED 120 VR YE black
2 + PE with varistor and LED (230 V), PG9	GMNL 209 NJ LED 230 VR YE black	GML 209 NJ LED 230 VR YE black
Single-Ended Cordsets		
2 + PE, without circuitry (230 V), PUR cable	VBD 1D-3-1-226/*M	VB 1D-3-1-226/*M
2 + PE with suppressor diode and LED (24 V), PUR cable	VBD 1B-1-1-226/*M	VB 1B-1-1-226/*M
2 + PE with varistor and LED (24 V), PUR cable	VBD 1A-1-1-226/*M	VB 1A-1-1-226/*M
2 + PE with varistor and LED (110 V), PUR cable	VBD 1A-2-1-226/*M	VB 1A-2-1-226/*M
2 + PE with varistor and LED (230 V), PUR cable	VBD 1A-3-1-226/*M	VB 1A-3-1-226/*M
Receptacles		
Rectangular, 2 + PE (230 V)	GSN 20 black	GSA 20 black

These articles are exemplary configurations. Please use our configurator on page 20 for more options.





Valve Connectors Type C

Small in Size, Strong in Impact

These highly versatile rectangular connectors fit almost anywhere with their space-saving design and are engineered for applications where reliability and precision are imperative.

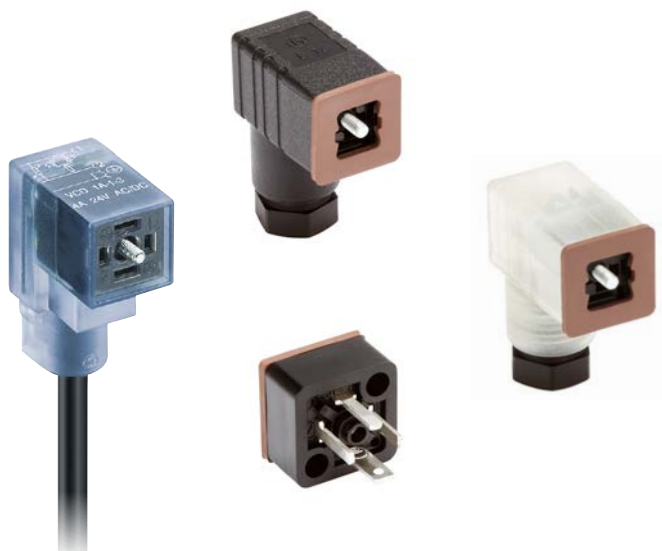

The Benefits

Small size – due to its compact housing design, type C valve connectors are ideally suited for use in confined spaces

Strong impact – integrated circuitries protect from inductive voltage and thus provide for a secure and reliable connection

Proven technology – valued worldwide and approved by various institutions such as UL, VDE or CSA

Markets

- Manufacturing Automation
- Machine Building
- Mobile Machinery
- Material Handling
- Transportation
- Process Automation

Technical Information

Type C	GDSN(L)/GDS(L)	VC/VCD	GSS(N)A/GSS(N)R
General Data			
Standard	DIN EN 175301-803-C / Industry Standard	DIN EN 175301-803-C / Industry Standard	DIN EN 175301-803-C / Industry Standard
Assembly Design	Field attachables	Cordsets	Receptacles
Housing Color	Black, Transparent, Grey	Black, Transparent	Black
No. of Pins	2 + PE, 3 + PE	2 + 2 PE	2 + PE, 3 + PE
Cable Range	PG 7: Ø 4.5-6 mm	–	–
Cable Material	–	PUR, PVC	–
Terminal Type	Screw	–	Solder
Conductor Size	Max. 0.75 mm ²	0.5 mm ²	0.34 mm ²
Electrical Data			
Operating Voltage¹⁾	230 V AC/DC	230 V AC/DC	230 V AC/DC
Current¹⁾	6 A	4 A	6 A
Environmental Data			
Ambient Temperature²⁾	Black: -40 °C to +125 °C Transparent: -25 °C to +90 °C	-25 °C to +80 °C	-40 °C to +125 °C
Protection Degree	IP65	IP67	IP65
Approvals	VDE, UL, CSA, SEV	–	VDE, UL, CSA, SEV

1) In combination with circuitries values may deviate. Please review data sheet for more information.

2) Notice derating





Product Configurator

Type C Field Attachables

G D S N L 2 0 7 L E D 2 4 V R Y E B L A C K

Design

- GDSN = Type C, female connector, field attachable, DIN standard, without circuitry
- GDSNL** = Type C, female connector, field attachable, DIN standard, with circuitry
- GDS = Type C, female connector, field attachable, industry standard, without circuitry
- GDSL = Type C, female connector, field attachable, industry standard, with circuitry

Pin Assignment and Cable Gland

20 = 2 + PE 30 = 3 + PE

Cable Gland

7 = PG7

LED

- = Without LED
- LED** = With LED

Voltage

24 = 24 V
120 = 110 V
230 = 230 V

Circuitry

- = Without circuitry
- VR = Varistor

LED Color (if LED was chosen)

YE = Yellow

Connector Color

- BLACK** = Black housing or in case of LED, transparent housing with black cable gland
- GREY = Grey housing or in case of LED, transparent housing with grey cable gland

Type C Cordsets

V C D 1 A - 1 - 3 - 2 1 2 / 2 M

Design

- VCD** = Type C, female connector, 2 + PE, molded, DIN standard
- VC = Type C, female connector, 2 + PE, molded, industry standard

Pin Assignment

- 1D = No circuitry
- 1A** = Varistor, LED yellow
- 1B = Suppressor diode, LED yellow
- 1L = LED yellow

Voltage

1 = 24 V
2 = 110 V
3 = 230 V

Ground

3 = PE at 0° and 180°

Control Cable

- 226 = PUR, 3G0.50 mm², Black
- 212** = PVC, 3G0.50 mm², Black
- G: With PE

Cable Length

2 M = 2 meter 5 M = 5 meter 10 M = 10 meter

@ Haven't yet found the cable or length you need?
Please aks for further options at icos-sales@belden.com

Order Overview – Exemplary Configurations

Type C	DIN Standard 2 + PE	DIN Standard 3 + PE	Industry Standard 2 + PE DIN	Industry Standard 3 + PE
<p>1. Choose Coding →</p> <p>2. Choose Design ↓</p>				
Field Attachables				
2 + PE, without circuitry (230 V)	GDSN 207 black	GDSN 307 black	GDS 207 black	GDS 307 black
2 + PE, with LED (24 V)	GDSNL 207 LED 24 YE black	–	–	–
2 + PE, with LED (120 V)	GDSNL 207 LED 120 YE black	–	–	–
2 + PE, with LED (230 V)	GDSNL 207 LED 230 YE black	–	–	–
2 + PE, with LED and varistor (24 V)	GDSNL 207 LED 24 VR YE black	–	–	–
2 + PE, with LED and varistor (110 V)	GDSNL 207 LED 110 VR YE black	–	–	–
2 + PE, with LED and varistor (230 V)	GDSNL 207 LED 230 VR YE black	–	–	–
Single-Ended Cordsets				
2 + PE, without circuitry (230 V), PUR cable	VCD 1D-3-3-226/* M	–	VC 1D-3-3-226/* M	–
2 + PE, with LED (24 V), PUR cable	VCD 1L-3-3-226/* M	–	VC 1L-3-3-226/* M	–
2 + PE, with LED and varistor (24 V), PUR cable	VCD 1A-1-3-226/* M	–	VC 1A-1-3-226/* M	–
2 + PE, with LED and varistor (110 V), PUR cable	VCD 1A-2-3-226/* M	–	VC 1A-2-3-226/* M	–
2 + PE, with LED and varistor (230 V), PUR cable	VCD 1A-3-3-226/* M	–	VC 1A-3-3-226/* M	–
2 + PE, with LED and suppressor diode (24 V), PUR cable	VCD 1B-1-3-226/* M	–	VC 1B-1-3-226/* M	–
Receptacles				
Rectangular for screw installation (230 V)	GSSNA 200	GSSNA 300	GSSA 200	GSSA 300
Circular for overmolding (230 V)	GSSNR 200	GSSNR 300	GSSR 200	GSSR 300

These articles are exemplary configurations. Please use our configurator on page 24 for more options.





Valve Connectors Accessories

Get the Most Out of Your Valve Connector

From low temperature gaskets up to stainless-steel non-corrosive screws, Belden offers the right accessories for almost every application.



The Benefits

More flexibility – Optimized for a large variety of challenges and environments

More functionality – Extraordinary impermeability and high environmental resistance

More comfort – Clever solutions ranging from captive gaskets up to toolless screws guarantee easy handling

Markets

- Manufacturing Automation
- Machine Building
- Mobile Machinery
- Material Handling
- Transportation
- Process Automation

Accessories Type A

Gaskets			GDM	GAN	GSA/GSC	GSAZ	GSE
Product Picture	Description	Temperature	Field Attachables	Cordsets	Receptacles		

Flat Gaskets

	GDM 3-7 NBR 50 pcs. per unit	-30 °C to +90 °C	●				
	GDM 3-21 EPDM 50 pcs. per unit	-40 °C to +125 °C	●				
	GDM 3-22 FKM 50 pcs. per unit	-15 °C to +125 °C	●				
	GDM 3-17 MPQ 50 pcs. per unit	-55 °C to +140 °C	●				
	GSA 200-4 NBR 50 pcs. per unit	-30 °C to +90 °C			●		
	GSA 200-7 EPDM 50 pcs. per unit	-40 °C to +125 °C			●		
	GSAZ 35/43 (40/62; 60/20) NBR 50 pcs. per unit	-30 °C to +90 °C				●	
	GSE 2000-2 NBR	-30 °C to +90 °C					●
	GSE 2000-3 EPDM	-40 °C to +125 °C					●

Profile Gaskets

	GDM 3-16 NBR 50 pcs. per unit	-30 °C to +90 °C	●				
	GDM 3-19 MPQ 50 pcs. per unit	-55 °C to +140 °C	●				
	GAN IP69 EPDM Gasket Package 50 pcs. per unit GAN Locking Clip 50 pcs. per Unit	-40 °C to +125 °C		●			

Accessories Type A

Gaskets & Central Screws			GDM	GAN	GSA / GSC	GSAZ	GSE
Product Picture	Description	Temperature	Field Attachables	Cordsets	Receptacles		

Captive Gaskets

	GDMF NBR 100 pcs. per unit	-30 °C to +90 °C	●				
	GDMF EPDM 100 pcs. per unit	-40 °C to +125 °C	●				

Steel Phillips combi slots

	GDM 3011-6 50 pcs. per unit	-55 °C to +125 °C	●				
	GAN-1 50 pcs. per unit	-55 °C to +125 °C		●			

Stainless Steel Phillips combi slots

	GDM 3011 RF-1 100 pcs. per unit	-55 °C to +125 °C	●				
	GAN RF-1 50 pcs. per unit	-55 °C to +125 °C		●			

Steel Torx-head





	GDM 3011-18 50 pcs. per unit	-55 °C to +125 °C	●				
--	---------------------------------	-------------------	---	--	--	--	--

Steel knurled PA-heads

	GDM 3011-7 grey 50 pcs. per unit	-55 °C to +125 °C	●				
	GDM 3011-7 black 50 pcs. per unit	-55 °C to +125 °C	●				



Accessories Type A

Other Accessories			GDM	GAN	GSA/GSC	GSAZ	GSE
							
Product Picture	Description	Temperature	Field Attachables	Cordsets	Receptacles		
Crimp Contacts							
	CuZn/CuSn RMC 480 100 pcs. per unit	-40 °C to +125 °C			●		
	CuZn/CuSn RMCB 480 3000 pcs. per unit	-40 °C to +125 °C			●		
Crimp Tool							
	XZC 0702 1 pcs. per unit				●		

Accessories Type B

Gaskets & Central Screws			GMN	GM	VBD	VB	GSN	GSA
Product Picture	Description	Temperature	DIN Field Attachables	Industry Field Attachables	DIN Cordsets	Industry Cordsets	DIN Receptacles	Industry Receptacles

Flat Gaskets

	GMN 209-3 NBR 50 pcs. per unit	-30 °C to +90 °C	●					
	GMN 209-12 EPDM 50 pcs. per unit	-40 °C to +125 °C	●					
	GM 207-3 NBR 50 pcs. per unit	-30 °C to +90 °C		●				
	GM 207-7 EPDM 50 pcs. per unit	-40 °C to +125 °C		●				
	GSN 20-3 NBR 50 pcs. per unit	-30 °C to +90 °C					●	
	GSA 20-3 NBR 50 pcs. per unit	-30 °C to +90 °C						●
	GSA 20-9 EPDM 50 pcs. per unit	-40 °C to +125 °C						●

Steel Phillips combi slot

	GDM 3011-6 50 pcs. per unit	-55 °C to +125 °C	●	●				
	VB(D) Central Screw 50 pcs. per unit	-55 °C to +125 °C			●	●		

Stainless Steel Phillips combi slot

	GDM 3011 RF-1 100 pcs. per unit	-55 °C to +125 °C	●	●				
--	------------------------------------	-------------------	---	---	--	--	--	--

Accessories Type C

Gaskets & Central Screws			GDSN	GDS	VCD	VC	GSSNA	GSSA
Product Picture	Description	Temperature	DIN Field Attachables	Industry Field Attachables	DIN Cordsets	Industry Cordsets	DIN Receptacles	Industry Receptacles

Flat Gaskets

	GDSN 307-4 NBR 50 pcs. per unit	-30 °C to +90 °C	●					
	GDSN 307-5 EPDM 50 pcs. per unit	-40 °C to +125 °C	●					
	GDS 307-2 NBR 50 pcs. per unit	-30 °C to +90 °C		●				
	GDS 307-4 EPDM 50 pcs. per unit	-40 °C to +125 °C		●				
	GSSNA 300-5 NBR 50 pcs. per unit	-30 °C to +90 °C					●	
	GSSNA 300-6 EPDM 50 pcs. per unit	-40 °C to +125 °C					●	
	GSSA 300-5 NBR 50 pcs. per unit	-30 °C to +90 °C						●
	GSSA 300-6 EPDM 50 pcs. per unit	-40 °C to +125 °C						●

Steel Phillips combi slots

	GDSN 307-3 50 pcs. per unit	-55 °C to +125 °C	●					
	GDS 307-3 50 pcs. per unit	-55 °C to +125 °C		●				



Find the Perfect Product for Your Needs at catalog.belden.com

Discover our expanding online catalog, streamlined to provide users easy access to the most relevant and useful product information, even on mobile devices.

Whether you are searching for a particular product by part number or exploring our extensive portfolio by browsing through product categories, you will find the information you need. The filter functionality

gives you the ability to narrow down your search by features so that you can easily find the part you need.

The online catalog continues to be updated with new products and new information. However, if you can't find something please contact your Belden representative. They will be able to help you find it or connect you with the Connectivity Center to create it.

Search for part number, download technical data sheets, compare products or request a quote

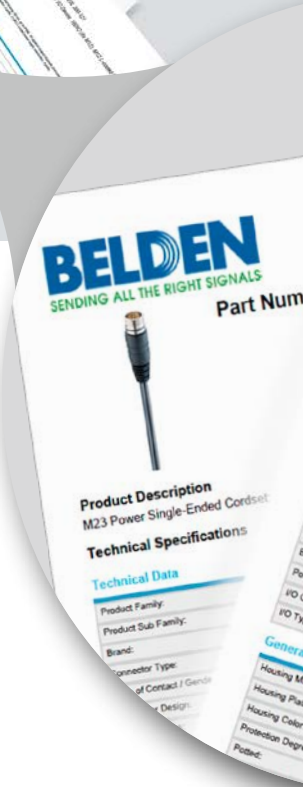



Our Technical Support is Ready to Serve You

You can expect our full support from implementation to the optimization of everyday operations regardless of the technology you use.

Welcome to our easy-to-use Helpdesk ticket system supporting Hirschmann & Lumberg Automation Connectivity Products

Hirschmann and Lumberg Automation Connectivity customers can rely on Belden's technical support through a state-of-the-art Helpdesk ticket system. Our portal for technical support allow us to handle your requests fast and efficient.

Use your preferred access for immediate technical help. Your usual customer service representative remains at your disposal to either enter the ticket in your name or possibly answer your question straight away.

Easy to Use and Navigate Support System



Lumberg Automation Support Portal
<https://lumberg-automation-support.belden.com>

HIRSCHMANN Support Portal
<https://hirschmann-support.belden.com>

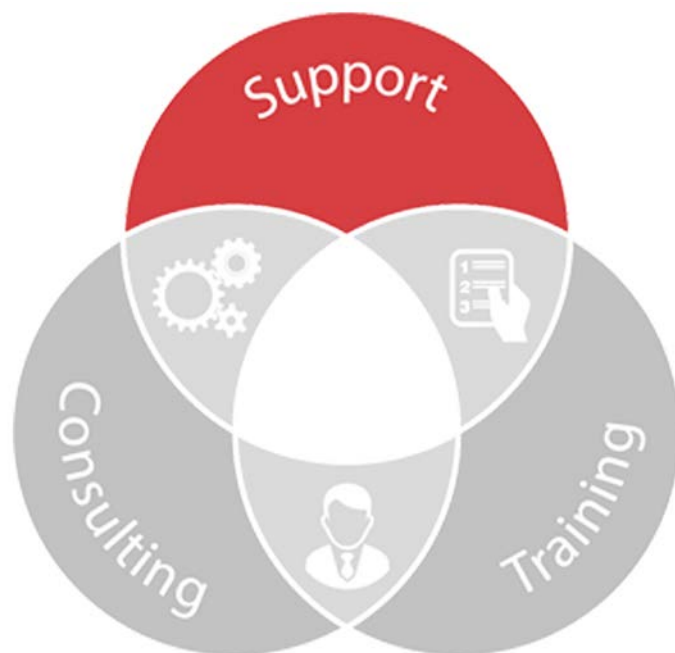



Custom-made Connectivity Solutions

The Connectivity Center

When it comes to automation technologies, we are the experts for quality connectors and wiring components. With an extensive connectivity portfolio, Lumberg Automation and Hirschmann can offer you a wide range of standard solutions.

Require a specialized solution that does not yet exist or have a problem with your current solution?

Then you simply get in touch with our Connectivity Center: the platform for custom-made solutions developed specifically for your needs. By combining all of our knowledge and internal resources, we will deliver the exact solution you need to smooth out your production process, warrant continuity and reduce Total Cost of Ownership.

The Best Solutions ... Fast!

With a dedicated team of experts, we can meet even the most demanding deadlines and technical challenges. Every month, the Connectivity Center delivers approximately 100 customized solutions for customers worldwide - some within just two weeks, hardly ever longer than three months. All solutions are guaranteed to have outstanding compact design, chemical resistance as well as high mechanical and electrical loading capacity.





Combined Strength of Three Belden Brands

Belden is a leader in the design, manufacture, and marketing of signal transmission products for data networking and a wide range of industrial connectivity products. Whenever necessary we combine the strength of all three powerful Belden brands: Belden, Hirschmann and Lumberg Automation.



Pushing Technology, Meeting Standards



As a globally active technology leader we can translate the latest trends, insights and developments into custom-fit solutions that give you the competitive advantage you are looking for. Thanks to extensive prototyping and intensive testing in our own facilities, you can be sure national and international standards are met. You can put our solutions straight to work.

Add Value to Your Business

You can be certain we provide signal transmission solutions that make your company operate faster, better, longer, safer and more economically. It's our ambition to deliver all these benefits to you from a single source, building a lasting relationship that adds value to your business.



Index – Type A

Article Description	Order Number
GAN21LU-D1U-2050500-1UZ	21099
GAN21LU-D1U-2260200-1UZ	20235
GAN21LU-V41-2120500	6831
GAN220U-AOU-2050200-1UM	5064
GAN220U-AOU-2050500-1UL	5065
GAN220U-AOU-2051000-1UK	5066
GAN220U-AOU-2260200	10552
GAN220U-AOU-2260200-1UM	5060
GAN220U-AOU-2260500	934889504
GAN220U-AOU-2260500-1UL	5062
GAN220U-AOU-2261000	934889505
GAN220U-AOU-2261000-1UK	5063
GAN220U-AOU-6030100-1UZ	18108
GAN220U-AOU-6030200	934889583
GAN220U-AOU-6030300-1UZ	18107
GAN220U-AOU-6030500	934889584
GAN220U-AOU-6031000	10551
GAN220U-V3U-2050200	5686
GAN220U-V3U-2120200	5685
GAN22LU-AOU-2050100-1UZ	7795
GAN22LU-AOU-2050200-1UZ	934889001
GAN22LU-AOU-2050500-1UZ	934889002
GAN22LU-AOU-2051000-1UZ	934889003
GAN22LU-AOU-2120200	6724
GAN22LU-AOU-2120500	11353
GAN22LU-AOU-2260200	10904
GAN22LU-AOU-2260500	934889004
GAN22LU-AOU-2261000	934889005
GAN22LU-AOU-6030200	934889083
GAN22LU-AOU-6030500	934889084
GAN22LU-AOU-6030500-1UZ	15739
GAN22LU-AOU-6030500-4UZ	9208
GAN22LU-AOU-6031000	10903
GAN22LU-AOU-6090200	934889081
GAN22LU-AOU-6090500	934889082
GAN22LU-AOU-6091000	934889129
GAN22LU-D24-2120200	934889012
GAN22LU-D24-2120500	934889013
GAN22LU-D24-2121000	934889014
GAN22LU-D24-2260200	934889015
GAN22LU-D24-2260500	934889016
GAN22LU-D24-2261000	934889017
GAN22LU-D24-6030500-1UZ	22345
GAN22LU-D24-6090200-1UZ	13956
GAN22LU-D24-6090500	10565
GAN22LU-D44-6031000-1UZ	18598
GAN22LU-L11-2260200	934889024
GAN22LU-L11-2260500	934889025
GAN22LU-L11-2261000	934889026
GAN22LU-L11-6030200	934889096
GAN22LU-L11-6030500	934889097
GAN22LU-L11-6031000	10553
GAN22LU-L11-6090200	934889094
GAN22LU-L11-6090500	934889095
GAN22LU-L11-6091000	10554
GAN22LU-L14-2120100-1UZ	18110
GAN22LU-L14-2120200	934889018
GAN22LU-L14-2120500	934889019
GAN22LU-L14-2121000	934889020
GAN22LU-L14-2260200	934889021
GAN22LU-L14-2260500	934889022
GAN22LU-L14-2261000	934889023
GAN22LU-L14-6030050	934889157
GAN22LU-L14-6030100-4UZ	934889136

Article Description	Order Number
GAN22LU-L14-6030200	934889091
GAN22LU-L14-6030500	934889093
GAN22LU-L14-6031000	9389
GAN22LU-L14-6090200	934889089
GAN22LU-L14-6090500	934889090
GAN22LU-L14-6091000-1UZ	10555
GAN22LU-L1Y-2120200	934889027
GAN22LU-L1Y-2120500	934889028
GAN22LU-L1Y-2121000	934889029
GAN22LU-L1Y-2260200	934889030
GAN22LU-L1Y-2260500	934889031
GAN22LU-L1Y-2261000	934889032
GAN22LU-L1Y-6030200	934889100
GAN22LU-L1Y-6030500	934889101
GAN22LU-L1Y-6031000	10556
GAN22LU-L1Y-6090200	934889098
GAN22LU-L1Y-6090500	934889099
GAN22LU-L1Y-6091000	10557
GAN22LU-S22-2050100-1UZ	20491
GAN22LU-S24-2120200	934889033
GAN22LU-S24-2120500	934889034
GAN22LU-S24-2121000-1UF	934889035
GAN22LU-S24-2122000	21081
GAN22LU-S24-2260100	8084
GAN22LU-S24-2260200	934889036
GAN22LU-S24-2260500	934889038
GAN22LU-S24-2261000	934889039
GAN22LU-S24-6030200	934889105
GAN22LU-S24-6030500	934889106
GAN22LU-S24-6031000	7935
GAN22LU-S24-6031000-4UZ	15745
GAN22LU-S24-6090100-4UZ	934889167
GAN22LU-S24-6090200	934889102
GAN22LU-S24-6090500	934889103
GAN22LU-S24-6091000	8322
GAN22LU-V21-2120200	7641
GAN22LU-V21-2120500	7642
GAN22LU-V21-2121000	7643
GAN22LU-V21-2260100	6309
GAN22LU-V21-2260200	934889040
GAN22LU-V21-2260500	934889041
GAN22LU-V21-2261000	934889042
GAN22LU-V21-6030200	934889117
GAN22LU-V21-6030500	934889118
GAN22LU-V21-6031000	10559
GAN22LU-V21-6090200	934889115
GAN22LU-V21-6090500	934889116
GAN22LU-V24-2120100-1UZ	18111
GAN22LU-V24-2120200	934889043
GAN22LU-V24-2120500	934889045
GAN22LU-V24-2121000	934889046
GAN22LU-V24-2260200	934889048
GAN22LU-V24-2260500	934889050
GAN22LU-V24-6090200	21295
GAN22LU-V24-6090500	7784
GAN22LU-V24-6091000	21309
GAN22LU-V28-6090200-1UZ	21174
GAN22LU-V28-6090500-1UZ	21414
GAN22LU-V28-6091000-1UZ	21408
GAN22LU-V2Y-2120200	934889055
GAN22LU-V2Y-2120500	934889056
GAN22LU-V2Y-2121000	934889057
GAN22LU-V2Y-2260200	934889058
GAN22LU-V2Y-2260500	934889059

Article Description	Order Number
GAN22LU-V2Y-2261000	934889060
GAN22LU-V2Y-6030200	6446
GAN22LU-V2Y-6030200	934889113
GAN22LU-V2Y-6030500	934889114
GAN22LU-V2Y-6031000	10563
GAN22LU-V2Y-6090200	934889111
GAN22LU-V2Y-6090500	934889112
GAN22LU-V2Y-6091000	10564
GAN22LU-V44-6090200-1UZ	16046
GAN22LU-V4Y-6091000-1UZ	21312
GAN310U-AOU-6040200	934889578
GAN310U-AOU-6040500	934889579
GAN310U-AOU-6041000	9641
GAN310U-AOU-7431000	9647
GAN31LU-AOU-6040200	934889078
GAN31LU-AOU-6040500	934889079
GAN31LU-AOU-6041000	7947
GAN31LU-AOU-6100200	934889075
GAN31LU-AOU-6100500	934889076
GAN31LU-AOU-6101000	934889077
GAN31LU-AOU-7430200	934889006
GAN31LU-AOU-7430500	934889007
GAN31LU-AOU-7431000	934889008
GAN31LU-AOU-7440200	934889009
GAN31LU-AOU-7440500	934889010
GAN31LU-AOU-7441000	934889011
GAN31LU-P1J-2280500	15036
GAN31LU-P1J-6110200	934889107
GAN31LU-P1J-6110500	934889108
GAN31LU-P1M-2280200	934889140
GAN31LU-P1M-2280500	16102
GAN31LU-P1M-6110200	934889109
GAN31LU-P1M-6111000	10546
GAN3ZLU-AOU-6100500	934889080
GAN3ZLU-P1M-6110500	8089
GAN-1	735676003
GAN RF-1	735623003
GDM2106-AOU-10F	934888100
GDM2106-AOU-1BF	934888134
GDM2106-AOU-1KD	18041
GDM2106-C3S-10D	934888007
GDM2106-C3U-10D	934888008
GDM2106-D1U-10D	934888010
GDM2106-D3U-10D	934888013
GDM2106-S1Q-10D	934888025
GDM2106-S3Q-10D	934888028
GDM2106-V1Q-10D	934888031
GDM2106-V1S-10D	934888032
GDM2106-V1U-10D	934888033
GDM2106-V3S-10D	934888037
GDM2106-V3U-10D	934888038
GDM2109-AOU-10F	934888104
GDM2109-AOU-1EF	21141
GDM2109-AOU-1KD	18042
GDM2109-D1U-1KD	21161
GDM2109-V3U-10D	19401
GDM2109-V3U-1ED	21302
GDM210A-AOU-10F	934888102
GDM210A-C3S-10D	934888043
GDM210A-C3U-10D	934888044
GDM210A-D1U-10D	934888046
GDM210A-D3U-10D	934888049
GDM210A-S1Q-10D	934888061
GDM210A-S3Q-10D	934888064



Type A

Article Description	Order Number	Article Description	Order Number	Article Description	Order Number
GDM210A-V1Q-10D	934888067	GDM21F6-V24-10D	934888034	GDM310B-AOU-10F	934888107
GDM210A-V1S-10D	934888068	GDM21F6-V28-10D	934888137	GDM310B-AOU-10S	13038
GDM210A-V1U-10D	934888069	GDM21F6-V2Y-10D	934888036	GDM310B-AOU-1KD	18048
GDM210A-V3S-10D	934888073	GDM21F6-V44-10D	934888039	GDM310B-D3U-1KD	20583
GDM210A-V3U-10D	934888074	GDM21F6-V48-10D	934888040	GDM310D-AOU-1KD	18049
GDM210B-AOU-10F	934888106	GDM21F6-V4Y-10D	18109	GDM316B-AOU-10F	934888113
GDM210B-AOU-1KD	18043	GDM21F9-D24-1AD	18685	GDM316B-AOU-10F	934888115
GDM210B-D3U-10D	934888135	GDM21F9-D24-1ED	21299	GDM31AB-AOU-10F	14122
GDM210B-V3U-10D	934888136	GDM21F9-D24-1KD	19923	GDM31AB-AOU-1ED	17394
GDM210D-AOU-10F	934888108	GDM21F9-L14-10D	19403	GDM31AJ-AOU-10F	934888126
GDM210D-AOU-1KD	18044	GDM21F9-L1Y-1ED	21300	GDM31AJ-AOU-1EF	19350
GDM210D-D3U-10D	934888156	GDM21F9-S24-10D	19404	GDM31AJ-AOU-1KD	18059
GDM210D-V3U-1KK	15490	GDM21F9-V2Y-10D	19405	GDM31AL-AOU-10D	17962
GDM2166-AOU-10F	934888131	GDM21F9-V2Y-1ED	21301	GDM31AL-AOU-10F	934888127
GDM2166-V3U-10D	934888165	GDM21F9-V44-10D	19406	GDM31AL-AOU-1EF	934888130
GDM216A-AOU-10F	934888164	GDM21FA-C4Y-10D	934888045	GDM31AL-AOU-1KD	18060
GDM216B-AOU-10F	934888122	GDM21FA-D24-10D	934888047	GDM31AL-AOU-1KK	15458
GDM216B-AOU-1AF	10545	GDM21FA-D28-10D	934888048	GDM31AM-AOU-10F	14640
GDM21A6-AOU-4LP	13599	GDM21FA-D44-10D	934888050	GDM31AM-AOU-1KD	18061
GDM21AB-AOU-10F	14121	GDM21FA-D48-10D	934888051	GDM31AN-AOU-10F	934888125
GDM21AJ-AOU-10F	934888124	GDM21FA-L11-10D	934888055	GDM31AN-AOU-1EF	934888166
GDM21AJ-AOU-1KD	18052	GDM21FA-L14-10D	934888053	GDM31AN-AOU-1KD	18063
GDM21AJ-AOU-4LP	13575	GDM21FA-L18-10D	934888054	GDM31AN-AOU-1KK	15459
GDM21AJ-D1U-10F	934888510	GDM21FA-L1Y-10D	934888056	GDM31AQ-AOU-10F	934888128
GDM21AJ-D3U-10F	934888513	GDM21FA-S22-10D	934888062	GDM31AQ-AOU-1KD	18064
GDM21AJ-V1Q-10F	934888531	GDM21FA-S24-10D	934888063	GDM31AQ-AOU-1KK	15460
GDM21AJ-V1S-10F	934888532	GDM21FA-S44-10D	934888065	GDM31AR-AOU-10F	934888158
GDM21AJ-V3S-10F	934888537	GDM21FA-V21-10D	934888071	GDM31F6-P1J-10D	934888021
GDM21AL-AOU-10D	17961	GDM21FA-V24-10D	934888070	GDM31F9-L14-10D	934888159
GDM21AL-AOU-10F	934888129	GDM21FA-V2Y-10D	934888072	GDMB106-AOU-10F	16422
GDM21AL-AOU-10F	934888112	GDM21FA-V44-10D	934888075	GDMF 2016 DAAA	934618001
GDM21AL-AOU-1KD	18054	GDM21FA-V48-10D	934888076	GDMF 2016 DBAA	934618003
GDM21AL-AOU-1KK	15455	GDM21FB-AOU-10F	20502	GDMF 2016 DCAA	934618004
GDM21AL-D1U-10D	12658	GDM21FB-D24-10D	18693	GDMF 2016 DEAA	934618005
GDM21AM-AOU-1KD	18056	GDM21FB-D24-1KK	20846	GDMF 2016 DFAA	934618006
GDM21AM-D1U-10F	934888546	GDM21FB-D28-10D	934888140	GDMF 2016 DGAA	934618007
GDM21AM-V1Q-10F	934888567	GDM21FB-D44-10D	934888139	GDMF 2016 DLAA	934618008
GDM21AM-V1S-10F	934888568	GDM21FB-L11-10D	934888141	GDMF 2016 DRAA	934618009
GDM21AM-V1U-10F	934888569	GDM21FB-L14-10D	21205	GDMF 3016 DAAA	934618002
GDM21AM-V3U-10D	934888574	GDM21FB-L14-1EQ	13851	GDMF 3116 DAAA	934618011
GDM21AN-AOU-10F	934888123	GDM21FB-L14-1KD	22166	GDMW 3011 DF black	932547200
GDM21AN-AOU-1KD	18057	GDM21FB-L1Y-10D	934888142	GDMW 3011 DF grey	932547206
GDM21AN-AOU-1KK	15456	GDM21FB-V24-10D	934888148	GSA 2000	932591100
GDM21AN-V3U-1KK	22518	GDM21FB-V28-10D	934888144	GSA 2000 N	932967100
GDM21AQ-AOU-1KD	18058	GDM21FB-V2Y-10D	934888145	GSA 3000	932597100
GDM21AQ-AOU-1KK	15457	GDM21FB-V44-10D	934888146	GSA 3000 N	932968100
GDM21AR-AOU-10F	934888157	GDM21FB-V48-10D	934888147	GSA-U 2000 N LO	933378100
GDM21F6-AOU-1KQ	18622	GDM21FD-D4Y	4402	GSA-U 3000 N LO	933379100
GDM21F6-C4Y-10D	934888009	GDM21FD-L14-10D	15125	GSAZ 200	932429100
GDM21F6-D24-10D	934888011	GDM21FJ-S24-10D	18888	GSAZ 300	932430100
GDM21F6-D28-10D	934888012	GDM21L6-V24-10D	934888084	GSC 300	931382100
GDM21F6-D44-10D	934888014	GDM3106-AOU-10F	934888101	GSE 2000 N4	932886100
GDM21F6-D48-10D	934888015	GDM3106-AOU-10S	21574	GSE 3000 N4	932890100
GDM21F6-D4Y-10D	934888167	GDM3106-AOU-1BF	934888150	GSP 2 M20	931298006
GDM21F6-L11-10D	934888019	GDM3106-AOU-1KD	18046	GSP 211 PG11	931298001
GDM21F6-L12-10D	934888016	GDM3106-AOU-40F	12307	GSP 212 1/2-14 NPTF-1	931298004
GDM21F6-L14-10D	934888017	GDM3109-AOU-10F	934888105	GSP 213 PG13,5	931298003
GDM21F6-L18-10D	934888018	GDM3109-AOU-1ED	17393	GSP 3 M20	931297006
GDM21F6-L1Y-10D	934888020	GDM3109-AOU-1EF	21143	GSP 313 PG 13,5 black	931297003
GDM21F6-S22-10D	934888026	GDM3109-AOU-1KD	18047	GSP 311 PG11 black	931297001
GDM21F6-S24-10D	934888027	GDM3109-AOU-30F	21426	GSP 316 PG16 black	931297002
GDM21F6-S24-1KD	20385	GDM3109-AOU-40F	14841	GSR-U 2000 LO	933377100
GDM21F6-S44-10D	934888029	GDM310A-AOU-10F	934888103	GSR-U 3000 LO	933376100
GDM21F6-V21-10D	934888035	GDM310A-AOU-1KD	22034		

Type B

Article Description	Order Number
GM 209 NJ grey	932977106
GM 209 NJ black	932977100
GM 216 NJ grey	934456106
GM 216 NJ black	934456100
GML 209 NJ GB1 LED 230 black	933933100
GML 209 NJ GB1 LED 24 grey	933642106
GML 209 NJ GB1 LED 24 black	933642100
GML 209 NJ GB1 black	933398100
GML 209 NJ LED 120 VR YE black	933934100
GML 209 NJ LED 120 YE grey	933712106
GML 209 NJ LED 120 YE black	933712100
GML 209 NJ LED 230 black	933931100
GML 209 NJ LED 230 VR YE grey	933932106
GML 209 NJ LED 230 VR YE black	933932100
GML 209 NJ LED 230 YE grey	933713106
GML 209 NJ LED 230 YE black	933713100
GML 209 NJ LED 24 black	933928100
GML 209 NJ LED 24 grey	933928106
GML 209 NJ LED 24 HH grey	933389106
GML 209 NJ LED 24 HH black	933389100
GML 209 NJ LED 24 VR YE grey	933929106
GML 209 NJ LED 24 VR YE black	933929100
GML 209 NJ LED 24 YE grey	933571106
GML 209 NJ LED 24 YE black	933571100
GML 216 NJ LED 24 HH grey	934458003
GML 216 NJ LED 24 HH black	934458002
GML 216 NJ LED 24 VR YE grey	934459003
GML 216 NJ LED 24 VR YE black	934459002
GMN 209 NJ grey	932987106
GMN 209 NJ black	932987100
GMN 216 NJ grey	934457106
GMN 216 NJ black	934457100
GMNL 209 NJ GB1 grey	933399106
GMNL 209 NJ GB1 LED 24 grey	933400106
GMNL 209 NJ GB1 LED 24 black	933400100
GMNL 209 NJ GB1 black	933399100
GMNL 209 NJ LED 120 YE black	933714100
GMNL 209 NJ LED 230 YE grey	933715106
GMNL 209 NJ LED 230 YE black	933715100
GMNL 209 NJ LED 24 HH grey	933388106
GMNL 209 NJ LED 24 HH black	933388100
GMNL 209 NJ LED 24 HH YE	933736100
GMNL 209 NJ LED 24 YE black	933572100
GMNL 216 NJ LED 24 HH grey	934460003

Article Description	Order Number
GMNL 216 NJ LED 24 HH black	934460002
GSA 20	931352100
GSN 20	932421100
VB 1A-1-1-212/10 M	26742
VB 1A-1-1-212/2 M	12189
VB 1A-1-1-212/5 M	12190
VB 1A-1-1-226/10 M	43845
VB 1A-1-1-226/2 M	43846
VB 1A-1-1-226/5 M	43848
VB 1A-1-2-212/10 M	46929
VB 1A-1-2-212/2 M	12196
VB 1A-1-2-212/5 M	12197
VB 1A-1-2-226/10 M	46930
VB 1A-1-2-226/2 M	43889
VB 1A-1-2-226/5 M	43891
VB 1A-1-2-241/10 M	60737
VB 1A-1-2-241/5 M	60740
VB 1A-2-1-212/5 M	18923
VB 1A-2-1-226/15 M	21337
VB 1A-2-1-226/2 M	934636972
VB 1A-2-1-226/5 M	5797
VB 1A-2-2-212/2 M	8213
VB 1A-2-2-212/5 M	8214
VB 1A-2-2-226/10 M	22550
VB 1A-2-2-226/5 M	50961
VB 1A-3-2-212/10 M	934636684
VB 1A-3-2-212/2 M	934636682
VB 1A-3-2-212/5 M	934636683
VB 1A-3-2-226/10 M	504
VB 1A-3-2-226/2 M	16070
VB 1A-3-2-226/5 M	16069
VB 1B-1-1-212/10 M	46931
VB 1B-1-1-212/2 M	12205
VB 1B-1-1-212/5 M	12206
VB 1B-1-1-226/2 M	16080
VB 1B-1-1-226/2,5 M	453
VB 1B-1-1-226/5 M	44674
VB 1B-1-2-212/10 M	11098
VB 1B-1-2-212/2 M	12211
VB 1B-1-2-212/5 M	12212
VB 1B-1-2-226/10 M	46934
VB 1B-1-2-226/2 M	16081
VB 1B-1-2-226/5 M	44400

Article Description	Order Number
VB 1B-1-2-269/10 M	1728
VB 1B-1-2-269/5 M	1722
VB 1D-3-1-205/10 M	46935
VB 1D-3-1-205/2 M	12213
VB 1D-3-1-205/5 M	12214
VB 1D-3-1-226/10 M	934637380
VB 1D-3-1-226/2 M	13500
VB 1D-3-1-226/5 M	59639
VB 1D-3-2-205/10 M	46936
VB 1D-3-2-205/2 M	12215
VB 1D-3-2-205/5 M	12216
VB 1F-1-1-212/5 M	14192
VBD 1A-1-1-212/10 M	82466
VBD 1A-1-1-212/2 M	12224
VBD 1A-1-1-212/5 M	12225
VBD 1A-1-1-226/10 M	43895
VBD 1A-1-1-226/2 M	12226
VBD 1A-1-1-226/5 M	12227
VBD 1A-1-2-212/15 M	11426
VBD 1A-1-2-212/5 M	12235
VBD 1A-1-2-226/10 M	43897
VBD 1A-1-2-226/2 M	12236
VBD 1A-1-2-226/5 M	12237
VBD 1B-1-1-212/10 M	46938
VBD 1B-1-1-212/2 M	12245
VBD 1B-1-1-212/5 M	12246
VBD 1B-1-1-226/10 M	46939
VBD 1B-1-1-226/2 M	43899
VBD 1B-1-1-226/5 M	44565
VBD 1B-1-1-269/10 M	22485
VBD 1B-1-2-212/10 M	11099
VBD 1B-1-2-212/2 M	12251
VBD 1B-1-2-212/5 M	12252
VBD 1B-1-2-226/10 M	46941
VBD 1B-1-2-226/2 M	43901
VBD 1B-1-2-226/5 M	43903
VBD 1D-3-1-205/10 M	2237
VBD 1D-3-1-205/2 M	12253
VBD 1D-3-1-205/5 M	12254
VBD 1D-3-1-226/10 M	9639
VBD 1D-3-2-205/10 M	46943
VBD 1D-3-2-205/2 M	12255
VBD 1D-3-2-205/5 M	12256



Type C

Article Description	Order Number
GDS 207 grey	933138106
GDS 207 black	933138100
GDS 307 grey	933024106
GDS 307 black	933024100
GDSN 207 grey	933137106
GDSN 207 black	933137100
GDSN 307 grey	933023106
GDSN 307 black	933023100
GSSA 200	933117100
GSSA 300	933116100
GSSNA 200	933110100
GSSNA 300	933111100
GSSNR 200	933113100
GSSNR 300	933112100
GSSR 200	933115100
GSSR 300	933114100
GDSNL 207 LED 24 YE black	935-012-112
GDSNL 207 LED 110 YE black	935-012-212
GDSNL 207 LED 230 YE black	935-012-312
GDSNL 207 LED 24 VR YE black	935-012-412
GDSNL 207 LED 110 VR YE black	935-012-512
GDSNL 207 LED 230 VR YE black	935-012-612
VC 1A-1-3-212/10 M	46944
VC 1A-1-3-212/2 M	12263
VC 1A-1-3-226/10 M	43905
VC 1A-1-3-226/2 M	43906
VC 1A-1-3-226/5 M	43909
VC 1A-1-3-269/10 M	12789
VC 1B-1-3-212/5 M	8522
VC 1B-1-3-226/10 M	56836
VC 1B-1-3-226/2 M	4183
VC 1B-1-3-226/5 M	1035
VC 1D-3-3-212/10 M	16217
VC 1D-3-3-212/2 M	12265
VC 1D-3-3-212/5 M	12266
VC 1D-3-3-226/10 M	934637382
VC 1D-3-3-226/5 M	934637381
VCD 1A-1-3-212/10 M	43445
VCD 1A-1-3-212/2 M	12274
VCD 1A-1-3-212/5 M	12275
VCD 1A-1-3-226/10 M	43911
VCD 1A-1-3-226/2 M	12276

Article Description	Order Number
VCD 1A-1-3-226/5 M	12277
VCD 1A-1-3-241/10 M	11096
VCD 1A-1-3-241/2 M	12279
VCD 1A-1-3-241/5 M	12280
VCD 1A-1-3-269/10 M	13226
VCD 1B-1-3-212/2 M	16189
VCD 1B-1-3-212/5 M	16049
VCD 1B-1-3-226/10 M	5543
VCD 1B-1-3-226/2 M	56724
VCD 1B-1-3-226/5 M	56837
VCD 1D-3-3-212/10 M	39149
VCD 1D-3-3-212/2 M	12281
VCD 1D-3-3-212/5 M	12282
VCD 1D-3-3-226/10 M	9634
VCD 1D-3-3-226/5 M	2765

Accessories

Article Description	Order Number
GAN IP69 Gasket Package	934887001
GAN Locking Clip	735656002
GAN-1	735676003
GAN RF-1	735623003
GDM 3011 RF-1	734363001
GDM 3011-18	735507002
GDM 3011-6	732383003
GDM 3011-7 black	732488901
GDM 3011-7 grey	732488002
GDM 3-16 NBR	731531002
GDM 3-17 MPQ	731740002
GDM 3-19 MPQ	731532002
GDM 3-21 EPDM	731739004
GDM 3-22 FKM	735724002
GDM 3-7 NBR	730801002
GDMF EPDM	735677004
GDMF NBR	735677003
GDS 307-2 NBR	730185002
GDS 307-3	730084002
GDS 307-4 EPDM	730314003
GDSN 307-3	730083002
GDSN 307-4 NBR	730176002
GDSN 307-5 EPDM	730310003
GM 207-3 NBR	731423002
GM 207-7 EPDM	731755004
GMN 209-12 EPDM	733271004
GMN 209-3 NBR	733273002
GSA 200-4 NBR	730843002
GSA 200-7 EPDM	730268003
GSA 20-3 NBR	731490002
GSA 20-9 EPDM	734033003
GSAZ 35/43 NBR	733262002
GSAZ 40/62 NBR	733264002
GSAZ 60/20 NBR	733266002
GSE 2000-2 NBR	733973002
GSE 2000-3 EPDM	733846003
GSN 20-3 NBR	733275002
GSSA 300-5 NBR	730233002
GSSA 300-6 EPDM	730312003
GSSNA 300-5 NBR	730232002
GSSNA 300-6 EPDM	730365004
RMC 480	731470021
RMCB 480	731468001
VB(D) Central Screw	30206
XZC 0702	932507003



About Belden

Belden Inc., a global leader in high quality, end-to-end signal transmission solutions, delivers a comprehensive product portfolio designed to meet the mission-critical network infrastructure needs of industrial, enterprise and broadcast markets. With innovative solutions targeted at reliable and secure transmission of rapidly growing amounts of data, audio and video needed for today's applications, Belden is at the center of the global transformation to a connected world. Founded in 1902, the company is headquartered in St. Louis, USA, and has manufacturing capabilities in North and South America, Europe and Asia.

For more information, visit us at:

www.belden.com

www.beldensolutions.com

follow us on Twitter @BeldenIND