

AM000040

ACCESSORIES • MOUNTING



MECHANICAL DATA

For sensor	MZR9
Height	25 mm
Length	27 mm
Material	Plastic
Mounting type	Screw mounting
Nominal diameter	16 mm
Surface	Untreated
To fix to	Cylinder, 16round
Width	19 mm

OTHER DATA

Suitable for fire protection areas	No
------------------------------------	----

DIMENSIONAL DRAWING

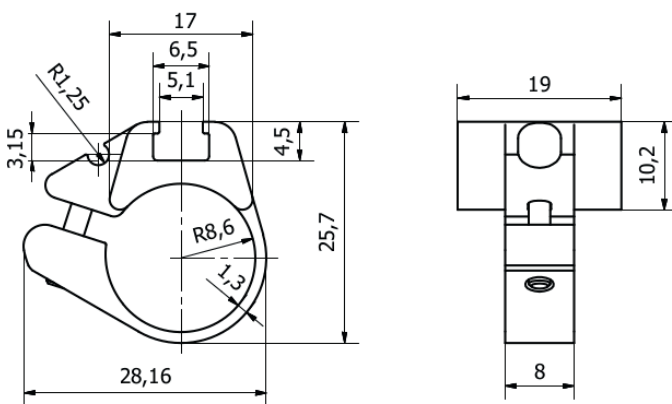

INSTALLATION

DISPOSAL



Mounting / Installation may only be carried out by a qualified electrician!



SAFETY WARNINGS

Before initial operation, please make sure to follow all safety instructions that may be provided in the product information!

Never use these devices in applications where the safety of a person depends on their functionality.