

Please keep for further use
Designed for colour printing

ENGLISH

RO710900 / RO710905

Other use of the device is outside the permitted purpose and can not be guaranteed by the manufacturer. The manufacturer cannot be held responsible for incorrect installations or inappropriate adjustments of the sensor.

Motion and presence sensor for automatic industrial doors

RO710900: for normal to high mounting (3.5 - 6 m)

RO710905: for low mounting (2 - 3.5 m)

DESCRIPTION

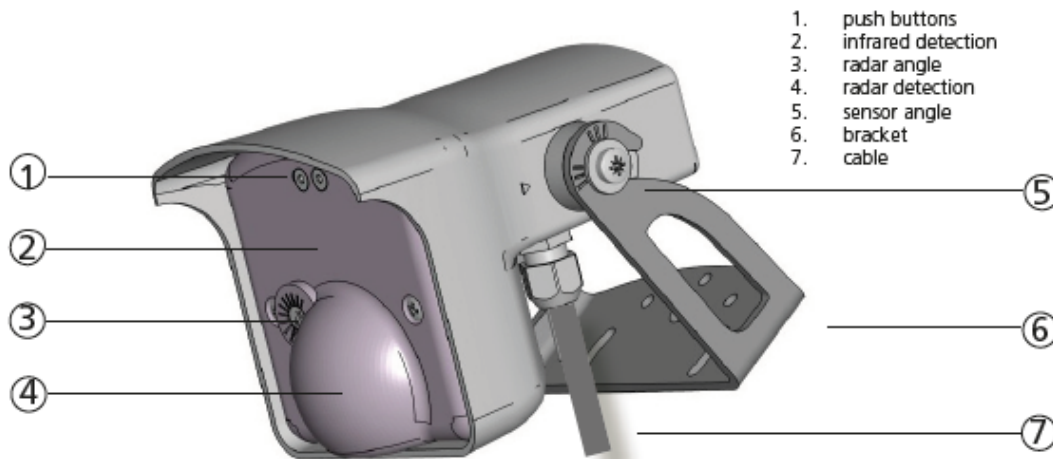

1. push buttons
2. infrared detection
3. radar angle
4. radar detection
5. sensor angle
6. bracket
7. cable







TECHNICAL SPECIFICATIONS

Supply voltage:	12V to 24V AC $\pm 10\%$; 12V to 24V DC +10% / -3%	
Power consumption:	< 3.5 W / VA	
Mains frequency:	50 to 60 Hz	
Output:	2 relays (free of potential change-over contact)	
Max. contact voltage:	42 V AC/DC	
Max. contact current:	1 A (resistive)	
Max. switching power:	30 W (DC) / 48 VA (AC)	
Output holdtime:	0.5 s	
Mounting height:	RO710900: 3.5 m - 6 m; RO710905: 2 m - 3.5 m*	
Temperature range:	from -30 °C to + 60 °C	
Humidity:	0 - 95% non condensing	
Degree of protection:	IP65	
Dimensions:	127 mm (L) x 102 mm (H) x 96 mm (W)	
Materials:	ABS and polycarbonate	
Weight:	400 g	
Cable length:	10 m	
Norm conformity:	R&TTE 1999/5/EC; EMC 2004/108/EC	
Technology:	microwave doppler radar	active infrared
Transmitter frequency/wavelength:	24.150 GHz	875 nm
Transmitter power density:	< 5 mW/cm ²	< 250 mW/m ²
Detection mode:	motion	motion & presence
Detection field:	RO710900: 4 x 5 m ; RO710905: 4 x 2 m**	4 m x 4 m (emitting spots***)
Min. detection speed:	5 cm/s	5 cm/s to activate detection
Reaction time:	100 ms	250 ms
Tilt angle:	-8° - 22° (relative to sensor front face)	15° - 45°

Specifications are subject to changes without prior notice.
Measured in specific conditions

* depending on size and nature of target
** measured at 30°, field size 9, mounting height: 5 m, XL: 3.5 m
*** zone detected by spotfinder, slightly bigger than actual detection field

LED- SIGNAL

-  Motion detection
Value indication
-  LED flashes
-  Presence detection
Parameter indication
-  LED flashes quickly
-  Setup
-  LED is off

DIMENSIONS (in mm)

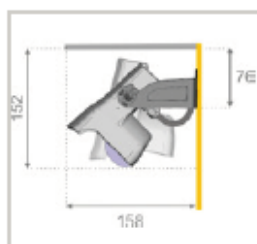

Wall mounting

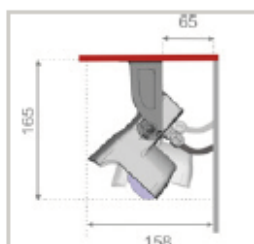

Ceiling mounting

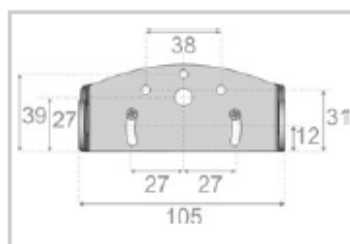

Bracket dimensions

SAFETY INSTRUCTIONS



Only trained and qualified personnel may install and setup the sensor.



After installation, save an access code to lock the sensor.



Test the good functioning of the installation before leaving the premises.



The warranty is void if unauthorized repairs are made or attempted by unauthorized personnel.

The manufacturer of the door system is responsible for carrying out a risk assessment and installing the sensor and the door system in compliance with applicable national and international regulations and standards on door safety.

MOUNTING TIPS



Do not cover the sensor.



Avoid extreme vibrations.



Avoid proximity to neon lamps or moving objects.

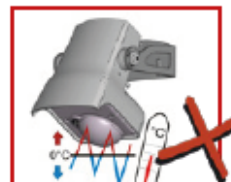

Avoid exposing the sensor to sudden temperature changes.

HOW TO USE THE REMOTE CONTROL



After unlocking, the red LED flashes and the sensor can be adjusted by remote control.



If the red LED flashes quickly after unlocking, enter an access code from 1 to 4 digits. If you do not know the access code, **cut and restore the power supply**. During 1 minute, you can access the sensor without introducing any access code.

ADJUSTING ONE OR MORE PARAMETERS



CHECKING A VALUE



The number of flashes indicates the value of the chosen parameter.

RESTORING TO FACTORY VALUES



SAVING AN ACCESS CODE

The access code is recommended for sensors installed close to each other.



DELETING AN ACCESS CODE



If you do not know the access code, **cut and restore the power supply**. During 1 minute, you can access the sensor without introducing any access code.

1 MOUNTING

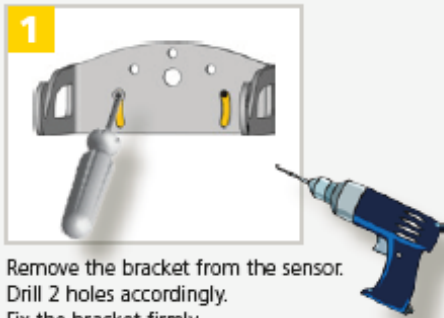

Remove the bracket from the sensor.
Drill 2 holes accordingly.
Fix the bracket firmly.

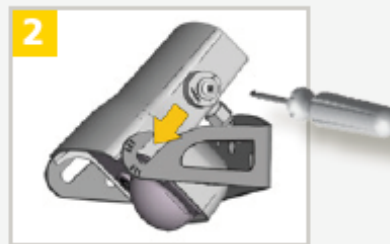

Position the sensor on the bracket and fasten the screws.

2 WIRING

GN		12-24 V	POWER SUPPLY
BN		AC-DC	
WH		COM	RADAR OUTPUT Motion signal
YE		NO	
GY		NC	
PK		COM	IR OUTPUT Presence signal
VT		NC	
BK		NO	



Connect the wires to the door controller.
Choose between NO and NC contact.

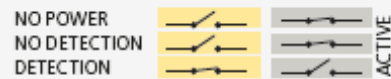

3 SENSOR ANGLE

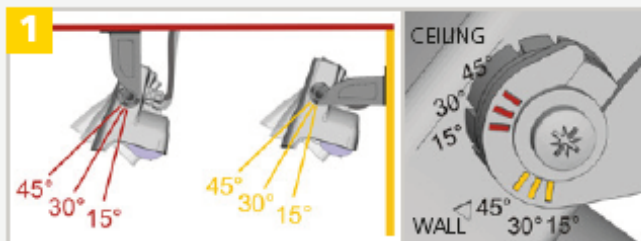

Adjust the angle of the sensor to position the detection fields.



Tighten the screws firmly.

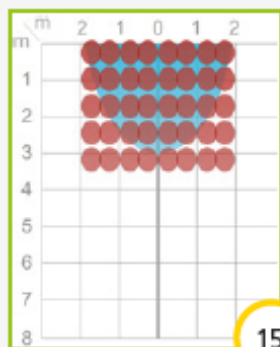

15°

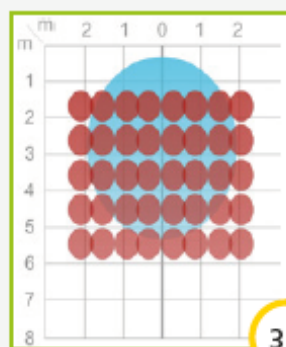

30°

RECOMMENDED

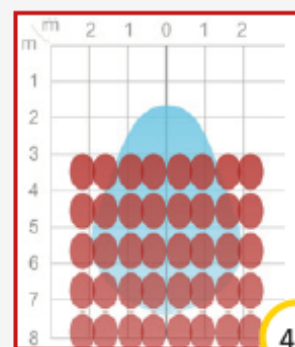

45°

NOT RECOMMENDED

All detection field dimensions are measured in specific conditions (mounting height 5 m, field size: 9).
Infrared field = emitting spots detectable by Spotfinder. The actual detection field is slightly smaller and influenced by external factors.

4 RADAR FIELD



By turning this screw, the radar field angle is reduced or increased (from -8° to +22°).

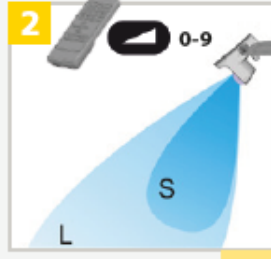

Adjust the field size. p. 6

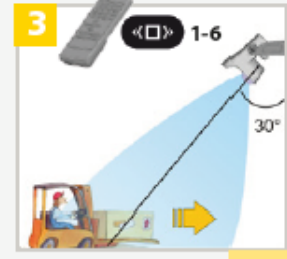

Choose the right detection filter for your application. p. 6

The total angle is the sum of the sensor angle and the radar field angle.

RO710900 RO710905

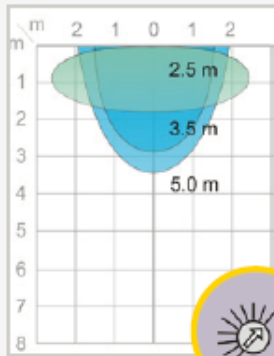

Sensor angle: 30°
Radar field angle: -8°
Total angle: 22°

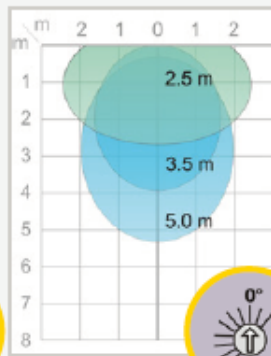

Sensor angle: 30°
Radar field angle: 0°
Total angle: 30°
Total angle = sensor angle

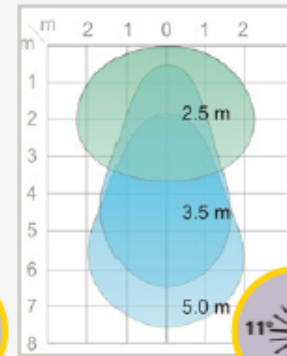

Sensor angle: 30°
Radar field angle: +11°
Total angle: 41°

All detection field dimensions are measured in specific conditions and with a field size value 9.

5 SETUP

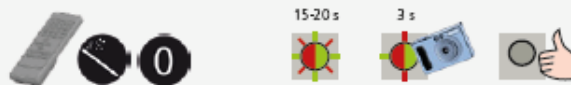

Launch a setup to make a reference picture.
Step out of the detection field and do not leave any tools inside the detection field.

After first power on, the sensor launches a setup and after each power cut a short setup is launched.

IMPORTANT: Test the good functioning of the installation before leaving the premises.

POSSIBLE REMOTE CONTROL SETTINGS



FIELD SIZE		XXS	XS	S	>	>	>	>	L	XL	XXL
DETECTION FILTER			1	2	3	4	5	6			
Detection of ALL TARGETS (pedestrians and parallel traffic are detected)						Detection only of VEHICLES MOVING TOWARDS THE SENSOR (pedestrians and parallel traffic are not detected + immunity filter)					
1 no specific filter 2 immunity filter against disturbances (recommended in case of vibrations, rain etc.)						3 if total angle is $\pm 15^\circ$ 4 if total angle is $\pm 30^\circ$ 5 if total angle is $\pm 45^\circ$ 6 if total angle is $> 45^\circ$ TIP: Always check if the chosen value is optimal for the application! The mounting height and object size or nature can influence the detection. The vehicle detection filter increases the response time of the sensor.					
DETECTION MODE			bi	uni	uni	AWAY					
bi = two-way detection uni = one-way detection towards sensor uni AWAY = one-way detection away from sensor											

OUTPUT REDIRECTION	F1	motion signal	motion + ir entry pulse	motion + ir exit pulse	motion + frontal ir entry pulse	motion + frontal ir exit pulse	motion + ir signal general	motion + ir signal limited	RELAY 1	RELAY 2	See application note for detailed instructions RO710900/RO710905
		presence	presence	presence	presence	presence	presence	presence			

FREQUENCY			A	B							
MAX. PRESENCE DETECTION TIME		30 s	1 min	2 min	5 min	10 min	20 min	1 h	1 h 30	2 h	$\infty+$ * not guaranteed
IR-CURTAIN IMMUNITY			low	normal	high						
MIN. SIZE OF TARGET	F2										The position of the target in the field is random.
IR-DETECTION FIELD	BE										

FACTORY VALUES





RESETTING TO FACTORY VALUES:



IMPORTANT: Always finish an adjustment session by launching a setup.



TROUBLESHOOTING

	The door remains closed and the LED is OFF.	The sensor power is off.	1 Check the wiring and the power supply.
	The infrared sensor does not react.	The infrared power emission is too low according to the mounting height.	1 Launch a new setup. Step out of the detection field!
	The door opens for no apparent reason.	The sensor detects raindrops or vibrations.	1 Make sure the detection mode is unidirectional. 2 Increase the detection filter value.
		The sensor is not installed properly.	1 Fasten the sensor firmly.
		In highly reflective environments, the sensor detects objects outside of its detection field.	1 Change the antenna angle. 2 Decrease the field size. 3 Increase the detection filter value.
	The vehicle detection filter is used, but pedestrians are still detected.	The chosen value is not optimal for the application.	1 Increase the detection filter value. 2 Decrease the sensor angle. 3 Increase the mounting height.
 	The door opens and closes constantly.	The sensor is disturbed by the door motion or vibrations caused by the door motion.	1 Make sure the sensor is fixed properly. 2 Make sure the detection mode is unidirectional. 3 Increase the sensor angle and/or radar angle. 4 Increase the detection filter value. 5 Reduce the field size.
		Sporadic presence detections for no reason.	The presence detection is disturbed by rain or lamps.
 	The red LED is permanently ON after a setup.	The sensor is not installed properly.	1 Fasten the sensor firmly.
		The sensor has failed the IR-setup.	1 Launch a new setup. Step out of the detection field!
	The setup lasts more than 30 seconds.	The setup is disturbed.	1 Make sure the detection field is clear and launch a new setup.
		Another sensor causes interferences.	1 Select a different frequency for each sensor.
	The sensor does not unlock and the red LED flashes quickly.	The sensor needs an access code to unlock.	1 Enter the right access code. 2 If you do not know the access code, cut the power supply and restore it to access the sensor and change the access code or delete it.
		The remote control batteries are weak or improperly installed.	1 Check the batteries and change them if necessary.
		The remote control is badly pointed.	1 Point the remote control towards the sensor.
	The sensor does not respond to the remote control.	The sensor is not powered.	1 Check the power supply of the sensor.

article no.: **RO710900** (installation height 3.5 ... 5m)
RO710905 (installation height 2 ... 3.5m)

accessory: remote control AR000001

Warning: Never use these articles in applications where the safety of a person depends on their functionality.