



HIRSCHMANN

A **BELDEN** BRAND

User Manual

Installation

GREYHOUND Switch

GRS1020/1120/1030/1130

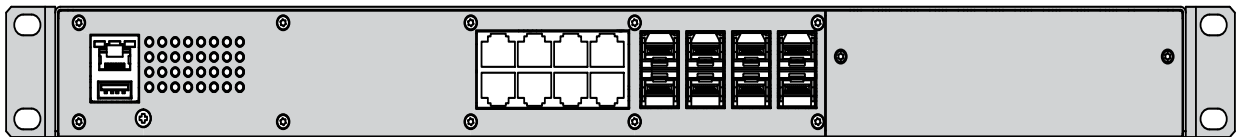

GRS 1020

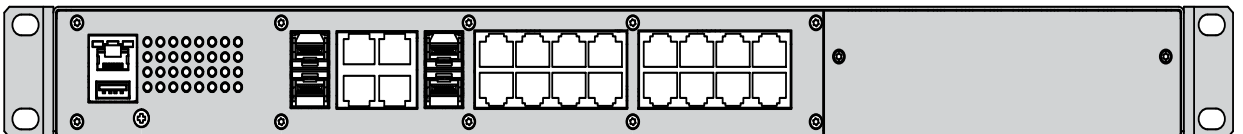

GRS 1030

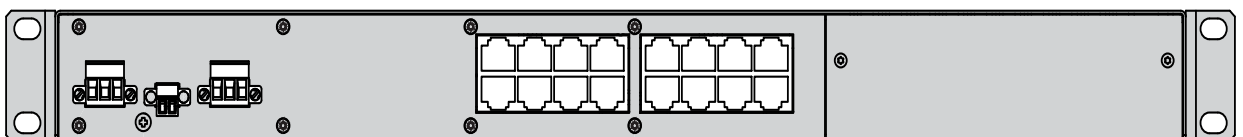

GRS 1120

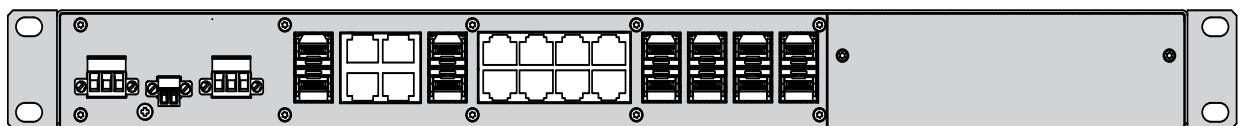

GRS 1130

The naming of copyrighted trademarks in this manual, even when not specially indicated, should not be taken to mean that these names may be considered as free in the sense of the trademark and tradename protection law and hence that they may be freely used by anyone.

© 2017 Hirschmann Automation and Control GmbH

Manuals and software are protected by copyright. All rights reserved. The copying, reproduction, translation, conversion into any electronic medium or machine scannable form is not permitted, either in whole or in part. An exception is the preparation of a backup copy of the software for your own use.

The performance features described here are binding only if they have been expressly agreed when the contract was made. This document was produced by Hirschmann Automation and Control GmbH according to the best of the company's knowledge. Hirschmann reserves the right to change the contents of this document without prior notice. Hirschmann can give no guarantee in respect of the correctness or accuracy of the information in this document.

Hirschmann can accept no responsibility for damages, resulting from the use of the network components or the associated operating software. In addition, we refer to the conditions of use specified in the license contract.

You can get the latest version of this manual on the Internet at the Hirschmann product site (www.hirschmann.com).

Hirschmann Automation and Control GmbH
Stuttgarter Str. 45-51
72654 Neckartenzlingen
Germany

Contents

Safety instructions	5
About this Manual	14
Legend	14
1 Description	15
1.1 General device description	15
1.2 Device name and product code	16
1.3 Combination options	20
1.4 Device views	21
1.4.1 Front view	21
1.4.2 Rear view	22
1.5 Power supply	23
1.5.1 Supply voltage with the characteristic value C	23
1.5.2 Supply voltage with the characteristic value M	23
1.6 Ethernet ports	23
1.6.1 Gigabit combo port	23
1.6.2 10/100 Mbit/s twisted pair port	25
1.6.3 100 Mbit/s F/O port (optional)	25
1.7 Display elements	26
1.7.1 Device state	26
1.7.2 Port status	27
1.7.3 Media module status	28
1.8 Management interfaces	29
1.8.1 V.24 interface (external management)	29
1.8.2 USB interface	29
1.9 Signal contact	30
2 Installation	31
2.1 Checking the package contents	31
2.2 Installing and grounding the device	31
2.3 Installing an SFP transceiver (optional)	35
2.4 Connecting the terminal blocks	36
2.4.1 Supply voltage with the characteristic value C	36
2.4.2 Supply voltage with the characteristic value M	37
2.4.3 Signal contact	38
2.5 Mounting a media module (optional)	39

2.6	Operating the device	40
2.7	Connecting data cables	40
2.8	Filling out the inscription label	40
3	Making basic settings	41
4	Monitoring the ambient air temperature	42
5	Maintenance and service	43
6	Disassembly	44
6.1	Removing the device	44
6.2	Removing an SFP transceiver (optional)	44
6.3	Removing a media module (optional)	45
7	Technical data	46
A	Further Support	58

Safety instructions

■ General safety instructions

You operate this device with electricity. Improper usage of the device entails the risk of physical injury or significant property damage. The proper and safe operation of this device depends on proper handling during transportation, proper storage and installation, and careful operation and maintenance procedures.

- Before connecting any cable, read this document, and the safety instructions and warnings.
- Operate the device with undamaged components exclusively.
- The device is free of any service components. In case of a damaged or malfunctioning the device, turn off the supply voltage and return the device to Hirschmann for inspection.

■ Qualification requirements for personnel

- Only allow qualified personnel to work on the device.

Qualified personnel have the following characteristics:

- ▶ Qualified personnel are properly trained. Training as well as practical knowledge and experience make up their qualifications. This is the prerequisite for grounding and labeling circuits, devices, and systems in accordance with current standards in safety technology.
- ▶ Qualified personnel are aware of the dangers that exist in their work.
- ▶ Qualified personnel are familiar with appropriate measures against these hazards in order to reduce the risk for themselves and others.
- ▶ Qualified personnel receive training on a regular basis.

■ Correct usage

Only use the device for those purposes specified in the catalog and in the technical description. Only operate the device with external devices and components that are recommended and permitted by the manufacturer. The proper and safe operation of this product depends on proper handling during transport, proper storage, assembly and installation, and conscientious operation and maintenance procedures.

■ National and international safety regulations

Verify that the electrical installation meets local or nationally applicable safety regulations.

■ Supply voltage

The supply voltage is electrically isolated from the housing.

- **Every** time you connect the electrical conductors, make sure that the following requirements are met:
 - ▶ The power supply conforms to overvoltage category I or II.
 - ▶ The power supply has an easily accessible disconnecting device (e.g., a switch or a plug). This disconnecting device is clearly identified. So in the case of an emergency, it is clear which disconnecting device belongs to which power supply cable.
 - ▶ The electrical wires are voltage-free.
 - ▶ The ground screw on the back of the device is connected to the protective conductor.
 - ▶ Supply with AC voltage:
 - A fuse is located in the outer conductor of the power supply. The neutral conductor is on ground potential at both voltage inputs. Otherwise, a fuse is also located in the neutral conductor.
 - Regarding the properties of this fuse:
[See “General technical data” on page 46.](#)
 - ▶ Supply with DC voltage:
 - A fuse suitable for DC voltage is located in the plus conductor of the power supply.
 - The minus conductor is on ground potential. Otherwise, a fuse is also located in the minus conductor.
 - Regarding the properties of this fuse:
[See “General technical data” on page 46.](#)
 - ▶ Supply with DC voltage: the fuse is suitable for a DC voltage.
 - ▶ If the neutral conductor (AC) or the negative conductor (DC) is not grounded: there is a fuse in each of the two wires.
 - ▶ Supply with AC voltage:
 - The wire diameter of the power supply cable is at least 0.75 mm² (North America: AWG18) on the supply voltage input.
 - ▶ Supply with DC voltage:
 - The wire diameter of the power supply cable is at least 1 mm² (North America: AWG16) on the supply voltage input.
 - ▶ The cross-section of the protective conductor is the same size as or bigger than the cross-section of the power supply cables.
 - ▶ The cables used are permitted for the temperature range of the application case.
 - ▶ Relevant for North America:
 - For use in Class 2 circuits, the copper wire conforms to class 1, 140/167 °F or 167 °F (60/75 °C or 75 °C).



WARNING

ELECTRIC SHOCK

Start connecting the electrical wires only if **all** the above safety requirements are fulfilled.

Failure to follow these instructions can result in death, serious injury, or equipment damage.

- Verify that the electrical installation meets locally or nationally applicable safety regulations.
- Use undamaged parts.
- Internal fuses are triggered only in the case of a detected error in the device. In case of damage or malfunction of the device, turn off the supply voltage and return the device to the plant for inspection.
- Only switch on the device when the housing is closed.
- First connect the ground screw on the back of the device with the protective conductor before you set up the other connections. When removing the connections, you remove the protective conductor last.
- For supply voltage connections with protective conductor connection: First connect the protective conductor before connecting the wires for the supply voltage.
If your device comprises a 2nd supply voltage connection of this type: First connect the protective conductor before connecting the wires for the supply voltages.

■ **Shielded ground**

The shielded ground wire of the twisted pairs cables is connected to the front panel as a conductor.

Beware of possible short circuits when connecting a cable section with conductive shield braiding.

■ Device casing

WARNING

ELECTRIC SHOCK

Never insert sharp objects (small screwdrivers, wires, etc.) into the inside of the device.

Never insert sharp objects (small screwdrivers, wires, etc.) into the connection terminals for electric conductors, and do not touch the terminals. Install this device solely in a switch cabinet or in an operating site with restricted access, to which maintenance staff have exclusive access.

Failure to follow these instructions can result in death, serious injury, or equipment damage.

WARNING

FIRE HAZARD

Install the device in a fire protected shell if you are mounting it vertically.

Failure to follow these instructions can result in death, serious injury, or equipment damage.

Only technicians authorized by the manufacturer are permitted to open the casing.

- Keep the ventilation slits free to ensure good air circulation.
- Make sure there is at least 3.94 inches (10 cm) of space in front of the ventilation slits of the housing.
- Do not touch the housing during operation or shortly after switching off the device. Hot surfaces can cause injury.
- Mount the device horizontally in a cabinet or vertically on a flat surface. Operating the device as a table unit is inadmissible.
[See “Installing and grounding the device” on page 31.](#)
- Operating the device in the maximum surrounding air temperature and stacking devices: When installing the device, make sure there is at least one free rack space (approx. 5 cm) above the device, because heat is discharged via the housing of the device.
- If you are operating the device in a 19" switch cabinet: install sliding/mounting rails for supporting the weight of the device.

■ **Operating conditions**

Operate the device at the specified ambient temperature (temperature of the ambient air at a distance of 2 inches (5 cm) from the device) and at the specified relative humidity exclusively.

- ▶ When you are selecting the installation location, make sure you observe the climatic threshold values specified in the technical data.
- ▶ Use the device in an environment with a maximum pollution degree that complies with the specifications in the technical data.

■ **Relevant for use in explosion hazard areas (Hazardous Locations, Class I, Division 2):**

The **relay connections** are to be installed and used within their entity parameters as per Control Drawing 000192283DNR. Details see the next two pages.

Avertissement - Risque d'explosion - Ne pas débrancher tant que le circuit est sous tension à moins que l'emplacement soit connu pour ne contenir aucune concentration de gaz inflammable.

Avertissement - Risque d'explosion - La substitution de tout composant peut rendre ce matériel incompatible pour une utilisation en classe I, division 2.

Any GREYHOUND-GRS1xxx device

**Class I, Division 2
Groups A, B, C, D
Hazardous Location**

Ordinary location,
non-hazardous area,
non-explosive atmosphere



Front view

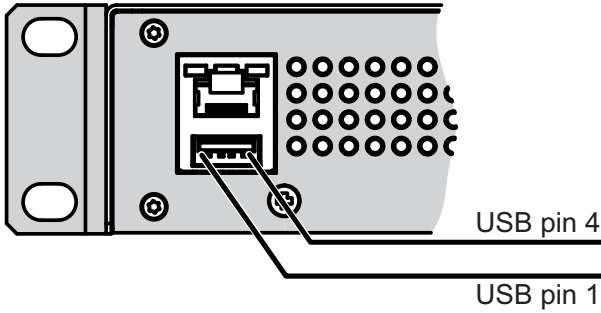

 Nonincendive field wiring parameters:
THE USB POWER SUPPLY CONTACTS DEPEND ON THE FOLLOWING PARAMETERS: *)

V_{oc}	I_{sc}	C_a	L_a
$\leq 5.5 \text{ V}$	$\leq 1.25 \text{ A}$	$10 \mu\text{F}$	$10 \mu\text{H}$

Back view

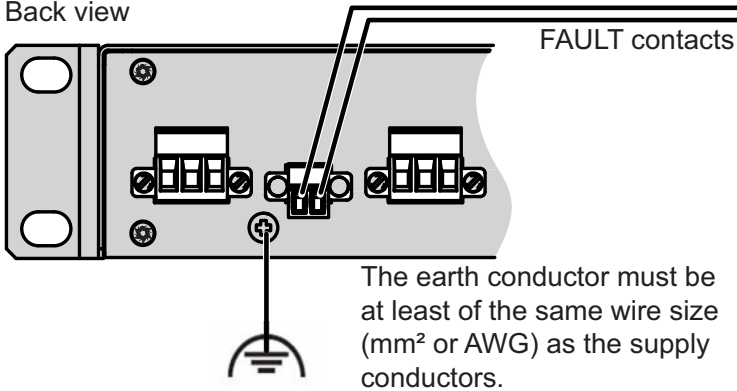

 Nonincendive field wiring parameters:
THE RELAY TERMINALS DEPEND ON THE FOLLOWING PARAMETERS: *)

V_{max}	I_{max}	C_a	L_a
30 V	90 mA	3 nF	$1 \mu\text{H}$

CONTROL DRAWING - GREYHOUND series for use in HAZARDOUS LOCATIONS
Class I, Division 2, Groups A, B, C, D



Rev.: 0

Document No.: 000192283DNR

Page 1/2

SUITABLE FOR USE IN CLASS I DIVISION 2 GROUPS A, B, C, D HAZARDOUS LOCATIONS, OR NON-HAZARDOUS LOCATIONS ONLY.

For use in **HAZARDOUS LOCATIONS** only allowed for model numbers which are labelled accordingly.



Nonincendive field wiring circuits must be wired in accordance with the National Electrical Code (NEC), NFPA 70, article 501; CEC, Appendix J, Annex J18. USB AND RELAY CONTACTS (FAULT): Install per Control Drawing 000192283DNR.

WARNING – EXPLOSION HAZARD – SUBSTITUTION OF ANY COMPONENTS MAY IMPAIR SUITABILITY FOR CLASS I DIVISION 2.

WARNING – EXPLOSION HAZARD – DO NOT DISCONNECT EQUIPMENT WHILE THE CIRCUIT IS LIVE OR UNLESS THE AREA IS KNOWN TO BE FREE OF IGNITABLE CONCENTRATIONS.

***) Notes:**

The nonincendive field wiring circuit concept allows interconnection of nonincendive field wiring apparatus and associated nonincendive field wiring apparatus using any of the wiring methods permitted for unclassified locations when certain parametric conditions are met.

$$\text{Capacity: } C_a \geq C_i + C_{\text{Cable}} ; \quad \text{Inductivity: } L_a \geq L_i + L_{\text{Cable}}$$

The **maximum cable length** has to be determined as follows:

(a) max. cable length $< (L_0 - L_i) / \text{Cable}_c$ or max. cable length $< (L_a - L_i) / \text{Cable}_L$
 ("Cable_L" denotes the inductance per unit length of used cable) and

(b) max. Cable Length $< (C_a - C_i) / \text{Cable}_c$
 ("Cable_c" denotes the capacitance per unit length of used cable).

The lower value of (a) and (b) is to apply.

Manufactured in 72654 Neckartenzlingen / Germany by Hirschmann Automation and Control GmbH.
 DOM: ww/yyyy (Date of manufacture w - week, y - year. Refer to the device label.)

**CONTROL DRAWING - GREYHOUND series for use in HAZARDOUS LOCATIONS
 Class I, Division 2, Groups A, B, C, D**



Rev.: 0

Document No.: 000192283DNR

Page 2/2

■ CE marking

The labeled devices comply with the regulations contained in the following European directive(s):

Device variant	Directive
All variants	2011/65/EU (RoHS) Directive of the European Parliament and of the Council on the restriction of the use of certain hazardous substances in electrical and electronic equipment.
All variants	2014/30/EU (EMC) Directive of the European Parliament and the council for standardizing the regulations of member states with regard to electromagnetic compatibility.
Only for device variants featuring supply voltage with the characteristic value M:	2014/35/EU Directive of the European Parliament and the council for standardizing the regulations of member states with regard to electrical equipment for use within specific voltage limits.

In accordance with the above-named EU directive(s), the EU conformity declaration will be at the disposal of the relevant authorities at the following address:

Hirschmann Automation and Control GmbH
Stuttgarter Str. 45-51
72654 Neckartenzlingen
Germany
www.hirschmann.com

The product can be used in the industrial sector.

- ▶ Interference immunity: EN 61000-6-2
- ▶ Emitted interference: EN 55022
- ▶ Reliability: EN 60950-1

Warning! This is a class A device. This device can cause interference in living areas, and in this case the operator may be required to take appropriate measures.

Note: The assembly guidelines provided in these instructions must be strictly adhered to in order to observe the EMC threshold values.

■ **LED or laser components**

LED or LASER components according to IEC 60825-1 (2014):

CLASS 1 LASER PRODUCT

CLASS 1 LED PRODUCT

■ **FCC note:**

This device complies with part 15 of the FCC rules. Operation is subject to the following two conditions: (1) this device may not cause harmful interference; (2) this device must accept any interference received, including interference that may cause undesired operation.

Appropriate testing has established that this device fulfills the requirements of a class A digital device in line with part 15 of the FCC regulations.

These requirements are designed to provide sufficient protection against interference when the device is being used in a business environment.

The device creates and uses high frequencies and can also radiate these frequencies. If it is not installed and used in accordance with this operating manual, it can cause radio transmission interference. The use of this device in a residential area can also cause interference, and in this case the user is obliged to cover the costs of removing the interference.

■ **Recycling note**

After usage, this device must be disposed of properly as electronic waste, in accordance with the current disposal regulations of your county, state, and country.

About this Manual

The “Installation” user manual contains a device description, safety instructions, a description of the display, and the other information that you need to install the device.

The documentation for your device is made up of the following documents:

- ▶ General safety instructions
- ▶ Installation user manual
- ▶ Basic Configuration user manual
- ▶ Redundancy Configuration user manual
- ▶ Reference manual for the graphical user interface
- ▶ Command Line Interface reference manual

The Industrial HiVision Network Management software provides you with additional options for smooth configuration and monitoring:

- ▶ ActiveX control for SCADA integration
- ▶ Auto-topology discovery
- ▶ Browser interface
- ▶ Client/server structure
- ▶ Event handling
- ▶ Event log
- ▶ Simultaneous configuration of multiple devices
- ▶ Graphical user interface with network layout
- ▶ SNMP/OPC gateway

Legend

The symbols used in this manual have the following meanings:

▶	Listing
□	Work step
■	Subheading

1 Description

1.1 General device description

You can choose from between a wide range of variants. You have the option to set up your device individually based on different criteria:

- ▶ Number of ports
- ▶ Transmission speed
- ▶ Types of connectors
- ▶ Temperature range
- ▶ Supply voltage range
- ▶ Certifications

The GREYHOUND devices are designed for the special requirements of industrial automation. They meet the relevant industry standards, provide very high operational reliability, even under extreme conditions, and also long-term reliability and flexibility.

The devices allow you to set up switched industrial Ethernet networks that conform to the IEEE 802.3 standard.

The devices work without a fan.

The following installation options are available:

- ▶ 19" switch cabinet
- ▶ Flat surface mounting

You have the option of choosing various media to connect to the terminal devices and other network components:

- ▶ twisted pair cable
- ▶ multimode F/O
- ▶ singlemode F/O

The ring redundancy concept allows the network to be reconfigured quickly after a failure.

Product configuration data can be provided by:

- ▶ diagnosis displays
- ▶ Displaying the operating parameters

There are convenient options for managing the device. Administer your devices via:

- ▶ a Web browser
- ▶ Telnet
- ▶ HiDiscovery (Software for putting the device into operation)
- ▶ network management software (e.g. Industrial HiVision)
- ▶ a V.24 interface (locally on the device)

The devices provide you with a large range of functions, which the manuals for the operating software inform you about. You will find these manuals as PDF files on the Internet on the Hirschmann product pages (www.hirschmann.com).

The Hirschmann network components help you ensure continuous communication across all levels of the company.

1.2 Device name and product code

The device name corresponds to the product code. The product code is made up of characteristics with defined positions. The characteristic values stand for specific product properties.

Item	Characteristic	Characteristic value	Description
1 ... 3	Product	GRS	GREYHOUND Switch
4	Series	1	GREYHOUND Series
5	Position of the ports and power supply inputs	0	Ethernet ports: front of device Power supply inputs: back of device
		1	Ethernet ports: back of device Power supply inputs: front of device
6	Data rate	2	10/100 Mbit/s
		3	10/100 Mbit/s with 100/1000 Mbit/s uplink ports
7	PoE support	0	None
8	(hyphen)	–	
9 ... 12	Configuration of the ports	16T9	16 × RJ45 socket for 10/100 Mbit/s twisted pair connections
		8T8Z	8 × RJ45 socket for 10/100 Mbit/s twisted pair connections
			8 × SFP slot for 100 Mbit/s F/O connections
13	Temperature range	S	Standard 0 °C ... +60 °C (+32 °F ... +140 °F)
		T	Extended –40 °F ... +158 °F (–40 °C ... +70 °C)
		E	Extended with conformal coating –40 °F ... +158 °F (–40 °C ... +70 °C)
14	Supply voltage 1	C	Voltage input Rated voltage range DC 24 V ... 48 V
		M	Voltage input Rated voltage range DC 110 V ... 250 V Rated voltage range AC 110 V ... 240 V, 50 Hz ... 60 Hz

Table 1: Device name and product code

Item	Characteristic	Characteristic value	Description
15	Supply voltage 2	C	Voltage input Rated voltage range DC 24 V ... 48 V
		M	Voltage input Rated voltage range DC 110 V ... 250 V Rated voltage range AC 110 V ... 240 V, 50 Hz ... 60 Hz
		9	None
16 ... 17	Certificates and declarations		You will find detailed information on the certificates and declarations applying to your device in a separate overview. See table 2 on page 18.
18 ... 19	Customer-specific version	HH	Hirschmann standard
20	Hardware configuration	S	Standard
21	Software configuration	E	Entry (Hirschmann Standard)
22 ... 23	Software level	2S	HiOS Layer 2 Standard
24 ... 28	Software version	04.1.	Software-Version 04.1
		XX.X.	Current software version

Table 1: Device name and product code

Application case	Certificates and declarations	Characteristic value ^a												
		Z9	Y9	X9	V9	VY	VU	VT	U9	UY	UX	UT	T9	TY
Standard applications	CE	X	X	X	X	X	X	X	X	X	X	X	X	X
	EN 60950-1	X	X	X	X	X	X	X	X	X	X	X	X	X
	EN 61131-2	X	X	X	X	X	X	X	X	X	X	X	X	X
	FCC	X	X	X	X	X	X	X	X	X	X	X	X	X
	ISA 12.12.01 – Class I, Div. 2			X							X			
	cUL 60950-1		X	X		X	X	X		X	X	X		X
Substation applications	IEC 61850-3				X	X	X	X						
	IEEE 1613				X	X	X	X						
Navy applications	DNV GL							(X)		(X)	(X)	(X)		
Railway applications (trackside)	EN 50121-4								X			X	X	X

Table 2: Assignment: application cases, certificates and declarations, characteristic values

- a. X = Approval or self-declaration is present
(X) = Approval or self-declaration is being prepared

Position Description	
1...3	Product: Greyhound Switch
4	Series: Greyhound Series
5	Position of the ports and Power supply inputs: Ethernet-Ports on the front of the device Voltage input on the back of the device
6	Data rate: 10/100 Mbit/s
7	PoE support: none
8	—
9...12	Number of 10/100 Mbit/s ports: 16
13	Temperature range: Standard: +32 °F ... +140 °F (0 °C ... +60 °C)
14	Supply voltage 1: Nominal voltage range DC Voltage input 24 V ... 48 V
15	Supply voltage 2: Nominal voltage range DC Voltage input 24 V ... 48 V
16...17	Approvals and declarations: CE, EN 60950-1, EN 61131-2, FCC
18...19	Customer-specific version: Hirschmann standard
20	Hardware configuration: Standard
21	Software configuration: Entry (Hirschmann Standard)
22...23	Software level: HiOS Layer 2 Standard
24...28	Software version 04.1

GRS	1	0	2	0	-	16T9	S	C	C	Z9	HH	S	E	2S	04.1.
-----	---	---	---	---	---	------	---	---	---	----	----	---	---	----	-------

Table 3: Sample product code GRS1020-16T9SCCZ9HHSE2S04.1

1.3 Combination options

Item	1 ... 3	4	5	6	7	8	9 ... 12	13	14	15	16 ... 17	18 ... 19	20	21	22 ... 23	24 ... 28
Characteristic	Device	Series	Position of the ports and power supply inputs	Data rate	PoE support		Configuration of the ports	Temperature range	Supply voltage 1	Supply voltage 2	Approvals & self-declarations	Customer-specific version	Hardware configuration	Software configuration	Software level	Software version
Attribute values	GRS	1	0, 1	2, 3	None	–	16T9, 8T8Z	S; T; E	C M	C, 9 C, M, 9	Z9; Y9; X9; V9; VY; VU; VT; U9; UY; UX; UT; T9; TY	HH	S	E	2S	04.1.

1.4 Device views

1.4.1 Front view

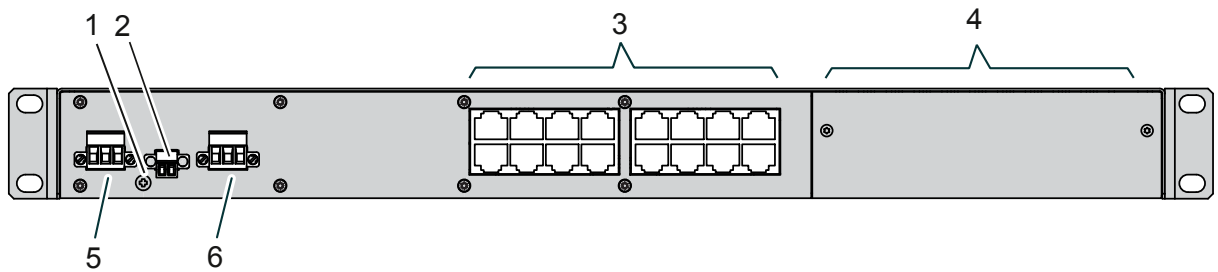

1	Grounding screw	
2	Connection for the signal contact	
3	16 × RJ45 socket for 10/100 Mbit/s twisted pair connections	
4	Cover panel	
5	Supply voltage connection 1	
	alternatively, depending on device variant	Supply voltage with the characteristic value C ▶ 2-pin terminal block
		Supply voltage with the characteristic value M ▶ 3-pin terminal block
6	Supply voltage connection 2	
	alternatively, depending on device variant	Supply voltage with the characteristic value C ▶ 2-pin terminal block
		Supply voltage with the characteristic value M ▶ 3-pin terminal block

Table 4: Front view using example of device variant GRS1120

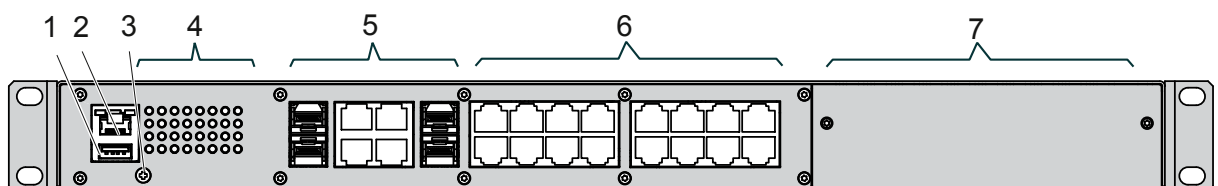

1	USB interface	
2	V.24 interface	
3	Grounding screw	
4	LED display elements	
5	4 × Combo port for 10/100/1000 Mbit/s connections	
6	16 × RJ45 socket for 10/100 Mbit/s twisted pair connections	
7	Cover panel	

Table 5: Front view using example of device variant GRS1030

1.4.2 Rear view

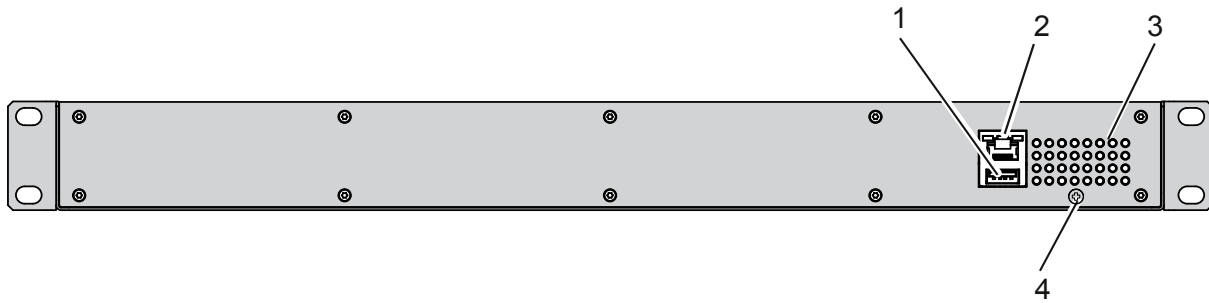

- | | |
|---|----------------------|
| 1 | USB interface |
| 2 | V.24 interface |
| 3 | LED display elements |
| 4 | Grounding screw |

Table 6: Back view of device variant GRS1130

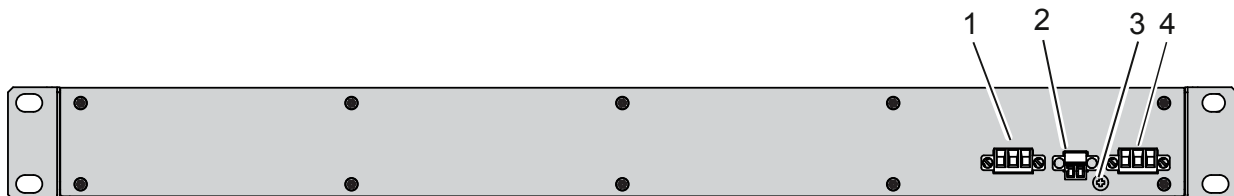

- | | | |
|---|--|---|
| 1 | Supply voltage connection 1 | |
| | alternatively, depending on device variant | Supply voltage with the characteristic value C ▶ 2-pin terminal block |
| | | Supply voltage with the characteristic value M ▶ 3-pin terminal block |
| 2 | Connection for the signal contact | |
| 3 | Grounding screw | |
| 4 | Supply voltage connection 2 | |
| | alternatively, depending on device variant | Supply voltage with the characteristic value C ▶ 2-pin terminal block |
| | | Supply voltage with the characteristic value M ▶ 3-pin terminal block |

Table 7: Back view of device variants GRS1020 and GRS1030

1.5 Power supply

You will find information on the characteristic values here:
[“Device name and product code” on page 16](#)

1.5.1 Supply voltage with the characteristic value C

A 2-pin terminal block is available to supply the device with power.

For further information see [“Supply voltage with the characteristic value C” on page 36](#).

1.5.2 Supply voltage with the characteristic value M

For the power supply of the device, a 3-pin terminal block is available.

For further information see [“Supply voltage with the characteristic value M” on page 23](#).

1.6 Ethernet ports

You can connect end devices and other segments to the device ports using twisted pair cables or optical fibers (F/O).

Note: By using media modules, you obtain up to 8 additional Fast Ethernet ports.

You will find more information on the media modules in the “User Manual for installation of GREYHOUND media modules”.

1.6.1 Gigabit combo port

The GREYHOUND device provides 4 combo ports for transmission speeds of up to 1000 Mbit/s.

[See table 18 on page 57](#).

You have the option of alternatively connecting a twisted pair cable via a RJ45 socket or an optical fiber via a SFP transceiver to a combo port.

You obtain appropriate SFP transceivers as an accessory.

[See “Accessories” on page 54](#).

By inserting an SFP transceiver, you automatically deactivate the assigned twisted pair port.

Media type	Connection options		
twisted pair cable		Technical standard	IEEE 802.3 10BASE-T/100BASE-TX/1000BASE-T
		Connection type	RJ45
Fiber optic cable	either	Technical standard	IEEE 802.3 100BASE-FX
		Connection type	Fast Ethernet SFP transceiver
	or	Technical standard	IEEE 802.3 1000BASE-SX/LX
		Connection type	1 Gigabit Ethernet SFP transceiver

Table 8: Combo ports: Connection options

■ 10/100/1000 Mbit/s twisted pair port

This port is an RJ45 socket.

The 10/100/1000 Mbit/s twisted pair port offers you the ability to connect network components according to the IEEE 802.3 10BASE-T/100BASE-TX/1000BASE-T standard.

This port supports:

- ▶ Autonegotiation
- ▶ Autopolarity
- ▶ Autocrossing (if autonegotiation is activated)
- ▶ 1000 Mbit/s full duplex
- ▶ 100 Mbit/s half-duplex mode, 100 Mbit/s full duplex mode
- ▶ 10 Mbit/s half-duplex mode, 10 Mbit/s full duplex mode

Delivery state: Autonegotiation activated

The socket housing is electrically connected with the front panel.

The pin assignment corresponds to MDI-X.

	Pin	Function
	1	BI_DB+
	2	BI_DB-
	3	BI_DA+
	4	BI_DD+
	5	BI_DD-
	6	BI_DA-
	7	BI_DC+
	8	BI_DC-

Table 9: Pin assignments of the 10/100/1000 Mbit/s twisted pair port in 1000 Mbit/s mode, RJ45 socket, MDI-X mode

1.6.2 10/100 Mbit/s twisted pair port

This port is an RJ45 socket.

The 10/100 Mbit/s twisted pair port offers you the ability to connect network components according to the IEEE 802.3 10BASE-T/100BASE-TX standard.

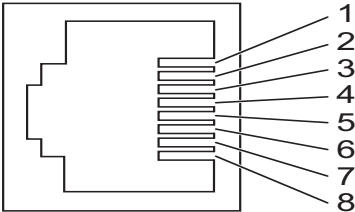
This port supports:

- ▶ Autonegotiation
- ▶ Autopolarity
- ▶ Autocrossing (if autonegotiation is activated)
- ▶ 100 Mbit/s half-duplex mode, 100 Mbit/s full duplex mode
- ▶ 10 Mbit/s half-duplex mode, 10 Mbit/s full duplex mode

Delivery state: Autonegotiation activated

The socket housing is electrically connected with the front panel.

	Pin	Function
	1	RD+ Receive path
	2	RD- Receive path
	3	TD+ Transmission path
	6	TD- Transmission path
	4,5,7,8	—

Table 10: Pin assignment 10/100 Mbit/s twisted pair port, RJ45 socket, MDI-X mode

1.6.3 100 Mbit/s F/O port (optional)

This port is an SFP slot.

The 100 Mbit/s F/O port offers you the ability to connect network components according to the IEEE 802.3 100BASE-FX standard.

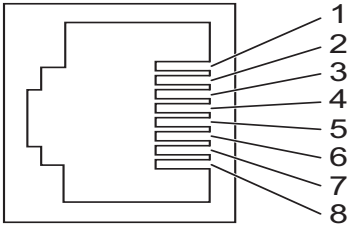
This port supports:

- ▶ 100 Mbit/s half-duplex mode, 100 Mbit/s full duplex mode

Default setting: Full duplex

1.7 Display elements

After the supply voltage is set up, the software starts and initializes itself. Afterwards, the device performs a self-test. During this process, various LEDs light up.

1.7.1 Device state

These LEDs provide information about conditions which affect the operation of the whole device.

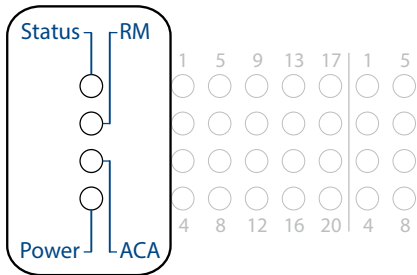

LED	Display	Color	Activity	Meaning
Status	Device Status	—	None	Device is starting and/or is not ready for operation
		Green	Lights up	Device is ready for operation. Characteristics can be configured
		Red	Lights up	Device is ready for operation. Device has detected at least one error in the monitoring results
		Flashes 1 time a period	The boot parameters used when the device has been started differ from the boot parameters saved. Start the device again.	
		flashes 4 times a period	Device has detected a multiple IP address	
RM	Ring Manager	—	None	No redundancy configured
		Green	Lights up	Redundancy exists
		Flashes 1 time a period	Device is reporting an incorrect configuration of the RM function	
		Yellow	Lights up	No redundancy exists
Power	Supply voltage	—	None	Supply voltage is too low
		Yellow	Lights up	Device variants with redundant power supply: Supply voltage 1 or 2 is on
		flashes 4 times a period	Software update is running. Maintain the power supply.	
		Green	Lights up	Device variants with redundant power supply: Supply voltages 1 and 2 are on Device variants with single power supply: Supply voltage is on

LED	Display	Color	Activity	Meaning
ACA	Storage medium ACA31	—	None	ACA storage medium not connected
		Green	Lights up	ACA storage medium connected
			Flashes 3 times a period	Device writes to/reads from the storage medium
		Yellow	Lights up	ACA storage medium inoperative

1.7.2 Port status

These LEDs provide port-related information.

Display	Color	Activity	Meaning
Link status	—	None	Device detects an invalid or missing link
	Green	Lights up	Device detects a valid link
		Flashes 1 time a period	Port is switched to stand-by
	Flashes 3 times a period	Port is switched off	
Yellow	Flashing	Device is transmitting and/or receiving data	

The LED display for F/O ports is located in the service panel of the basic device.

There are 2 LED displays for twisted pair ports and combo ports, located in the service panel of the basic device and directly on the relevant port:

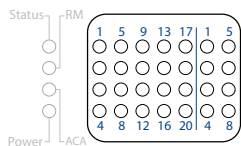
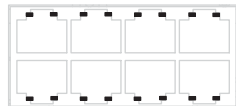
LED display		Position on the device
	Service panel	Front or back of the device depends on the device variant
	Port panel (for twisted pair ports only)	Front of the device

By default, the port status is displayed on the service panel. You have the option of changing between the LED displays using the command line interface (CLI). You require administrator rights for this.

To change to the LED display on the port panel, execute the following commands in the CLI:

```
enable
configure
system port-led-mode
portpanel
```

Change to the privileged EXEC mode.
Change to the configuration mode.
Change LED display from service panel to port panel.

To change to the LED display on the service panel, execute the following commands in the CLI:

```
enable
configure
system port-led-mode
servicepanel
```

Change to the privileged EXEC mode.
Change to the configuration mode.
Change LED display from port panel to service panel.

1.7.3 Media module status

1 LED is located on the media module at the bottom left. This LED provides information on the supply voltage status of the media module.

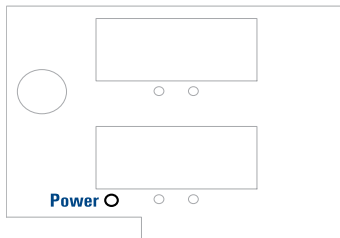

LED	Display	Color	Activity	Meaning
Power	Supply voltage	—	None	Media module is inoperative
		Green	Lights up	Supply voltage is on

1.8 Management interfaces

1.8.1 V.24 interface (external management)

A serial interface is provided on the RJ45 socket (V.24 interface) for the local connection of an external management station (VT100 terminal or PC with corresponding terminal emulation). This enables you to set up a connection to the Command Line Interface CLI and to the system monitor.

VT 100 terminal settings	
Speed	9600 Baud
Data	8 bit
Stopbit	1 bit
Handshake	off
Parity	none

The socket housing is electrically connected to the front panel of the device. The V.24 interface is electrically insulated from the supply voltage.

Figure	Pin assignment	Function
	1	—
	2	—
	3	TxD
	4	GND
	5	—
	6	RxD
	7	—
	8	—

Table 11: Pin assignment of the V.24 interface

Note: The Terminal cable is available as an accessory. See [“Accessories” on page 54](#).

1.8.2 USB interface

The USB interface allows you to connect the AutoConfiguration Adapter ACA21 storage medium. This is used for saving/loading the configuration data and diagnostic information, and for loading the software.

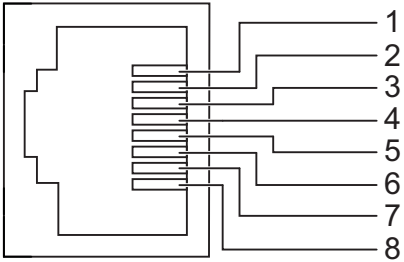
For information about the position on the device see [“Front view” on page 21](#).

On the front of the device there is an LED display that informs you about the status of the interface.

The USB interface has the following properties:

- ▶ Supplies current of max. 500 mA
- ▶ Voltage not potential-separated
- ▶ Connectors: type A
- ▶ Supports the USB master mode
- ▶ Supports USB 2.0

Figure	Pin	Operation
	1	VCC (VBus)
	2	- Data
	3	+ Data
	4	Ground (GND)

Table 12: Pin assignment of the USB interface

1.9 Signal contact

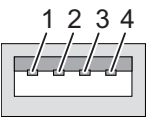
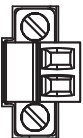

Figure 1: Signal contact: 2-pin terminal block with screw locking

The signal contact is a potential-free relay contact.

The device allows you to perform remote diagnosis via the signal contact. In the process, the device signals events such as a line interruption. When an event occurs, the device opens the relay contact and interrupts the closed circuit. The management setting specifies which events switch a contact. You can also use the management to switch the signal contact manually and thus control external devices.

2 Installation

The devices have been developed for practical application in a harsh industrial environment.

On delivery, the device is ready for operation.

Perform the following steps to install and configure the device:

- ▶ [Checking the package contents](#)
- ▶ [Installing and grounding the device](#)
- ▶ [Installing an SFP transceiver \(optional\)](#)
- ▶ [Connecting the terminal blocks](#)
- ▶ [Operating the device](#)
- ▶ [Connecting data cables](#)
- ▶ [Filling out the inscription label](#)

2.1 Checking the package contents

- Check whether the package includes all items named in the section [“Scope of delivery” on page 54](#).
- Check the individual parts for transport damage.

2.2 Installing and grounding the device

WARNING

ELECTRIC SHOCK

Install this device solely in a switch cabinet or in an operating site with restricted access, to which maintenance staff have exclusive access.

Failure to follow these instructions can result in death, serious injury, or equipment damage.

CAUTION

OVERHEATING OF THE DEVICE

When installing the device, ensure that the ventilation slots are not covered.

Failure to follow these instructions can result in injury or equipment damage.

■ Mounting in a switch cabinet

Note: Install the device in the 19" switch cabinet using sliding or mounting rails.

This provides a more stable position of your device in environments subject to vibration.

For more information on sliding/mounting rails and how to install them, please contact your switch cabinet manufacturer.

The devices are designed to be mounted in a 19" switch cabinet. In the delivery state, there are 2 pre-mounted holding brackets on the sides of the device.

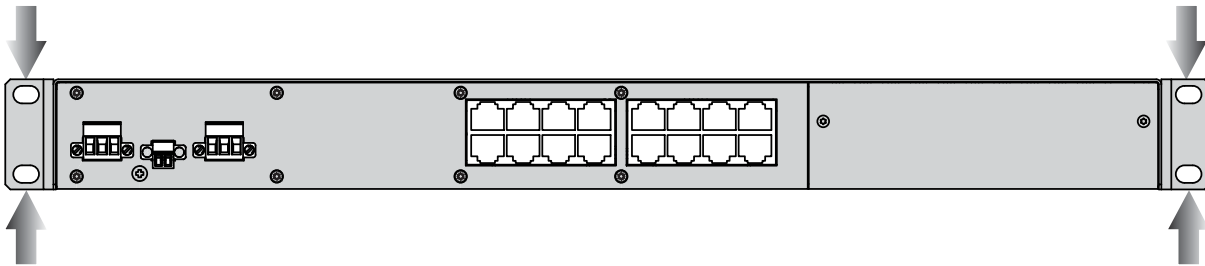

- Verify that there is sufficient ventilation. If required, install a fan to keep the device from overheating.
- Measure the depth of the 19" cabinet so that all the lines to be connected can be fed in easily.

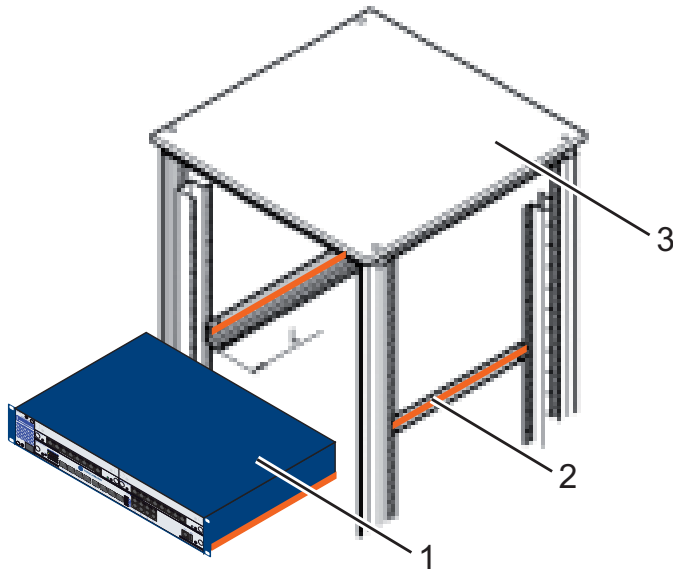

Figure 2: Assembly in a switch cabinet with sliding/mounting rails

1 - GREYHOUND device

2 - sliding/mounting rail

3 - 19" switch cabinet

Proceed as follows:

- Assemble the sliding or mounting rails in the 19" switch cabinet as specified by the manufacturer.
- Position the device on the rails in the switch cabinet.
- Fasten the device by screwing the brackets to the switch cabinet.

Note: When operating the device in an environment with strong vibrations, you have the option to additionally fasten the device to the switch cabinet using 2 holding brackets on the back of the device. You obtain the additional brackets as accessories.

See ["Accessories" on page 54](#).

■ Mounting on a vertical flat surface

WARNING

FIRE HAZARD

Install the device in a fire protected shell if you are mounting it vertically.

Failure to follow these instructions can result in death, serious injury, or equipment damage.

- Use the pre-mounted brackets as shown below.
- Additionally attach 2 brackets to the back of the device.
You obtain the additional brackets as accessories.
[See “Accessories” on page 54.](#)
- Fasten the device by screwing the brackets to the wall.

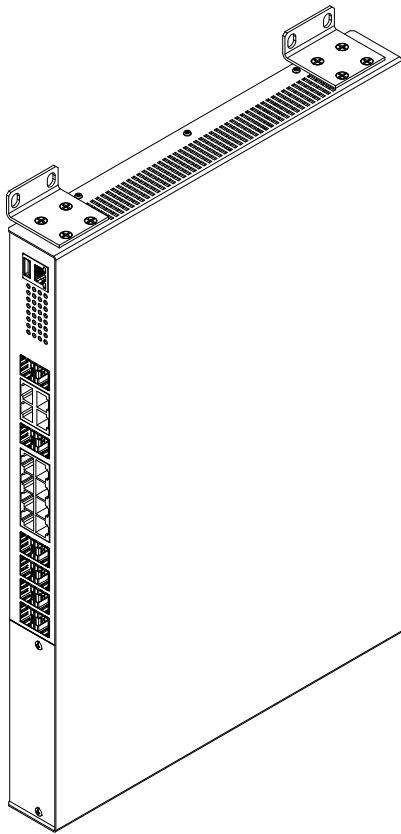

Figure 3: Mounting on a vertical flat surface

■ **Grounding the device**

The device variants have a connection for protective grounding. This applies to device variants with a supply voltage with the characteristic value M:

The device is grounded via the ground screw and also via the power supply socket.

[See figure 6 on page 37.](#)

- Ground the device via the ground screw.

2.3 Installing an SFP transceiver (optional)

- Remove the protection cap from the SFP transceiver.
- Push the SFP transceiver with the lock closed into the slot until it latches in.



Figure 4: F/O SFP transceiver

Use only Hirschmann SFP transceivers which are suitable for usage with the device.

[See “Accessories” on page 54.](#)

2.4 Connecting the terminal blocks

WARNING

ELECTRIC SHOCK

Connect only a supply voltage that corresponds to the type plate of your device.

Never insert sharp objects (small screwdrivers, wires, etc.) into the connection terminals for electric conductors, and do not touch the terminals.

Failure to follow these instructions can result in death, serious injury, or equipment damage.

Note: The supply voltage is connected to the device casing through protective elements exclusively.

2.4.1 Supply voltage with the characteristic value C

You will find information on the characteristic values here:

[“Device name and product code” on page 16](#)

You have the option of supplying the supply voltage redundantly, without load distribution.

Both supply voltage inputs are uncoupled.

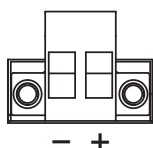

Figure 5: Supply voltage with the characteristic value C: 2-pin terminal block with screw locking

Type of the voltages that can be connected	Specification of the supply voltage	Connections
DC voltage	Rated voltage range DC 24 V ... 48 V Voltage range DC incl. maximum tolerances 18 V ... 60 V	+ Plus terminal of the supply voltage
		- Minus terminal of the supply voltage

Table 13: Supply voltage with the characteristic value C: type and specification of the supply voltage, pin assignment on the device

For **every** supply voltage to be connected, perform the following steps:

- Remove the power connector from the device.
- Connect the wires according to the pin assignment on the device with the clamps.
- Fasten the wires connected by tightening the terminal screws.

2.4.2 Supply voltage with the characteristic value M

You will find information on the characteristic values here:

[“Device name and product code” on page 16](#)

You have the option of supplying the supply voltage redundantly, without load distribution.

Both supply voltage inputs are uncoupled.

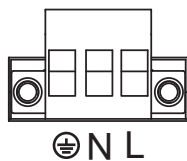

Figure 6: Supply voltage with the characteristic value M: 3-pin terminal block with screw locking



Type of the voltages that can be connected		Specification of the supply voltage	Connections
DC voltage	M	Rated voltage range DC 110 V ... 250 V Voltage range DC incl. maximum tolerances 88 V ... 288 V	+/L Plus terminal of the supply voltage -/N Minus terminal of the supply voltage  Protective conductor
AC voltage	M	Rated voltage range AC 110 V ... 240 V, 50 Hz ... 60 Hz Voltage range AC incl. maximum tolerances 88 V ... 276 V, 47 Hz ... 63 Hz	+/L Outer conductor -/N Neutral conductor  Protective conductor

Table 14: Supply voltage with the characteristic value M: type and specification of the supply voltage, connections



WARNING

ELECTRIC SHOCK

Install this device solely in a switch cabinet or in an operating site with restricted access, to which maintenance staff have exclusive access.

Failure to follow these instructions can result in death, serious injury, or equipment damage.

For **every** supply voltage to be connected, perform the following steps:

- Remove the power connector from the device.
- Connect the wires according to the pin assignment on the device with the clamps.
- Fasten the wires connected by tightening the terminal screws.

2.4.3 Signal contact

- Connect the signal contact wires with the connectors of the terminal block.
- Fasten the wires connected by tightening the terminal screws.

2.5 Mounting a media module (optional)

Hirschmann supplies the media modules in a ready-to-operate state. By using a media module, you obtain up to 8 additional Fast Ethernet ports. You have the option of mounting the media modules while the device is operating.

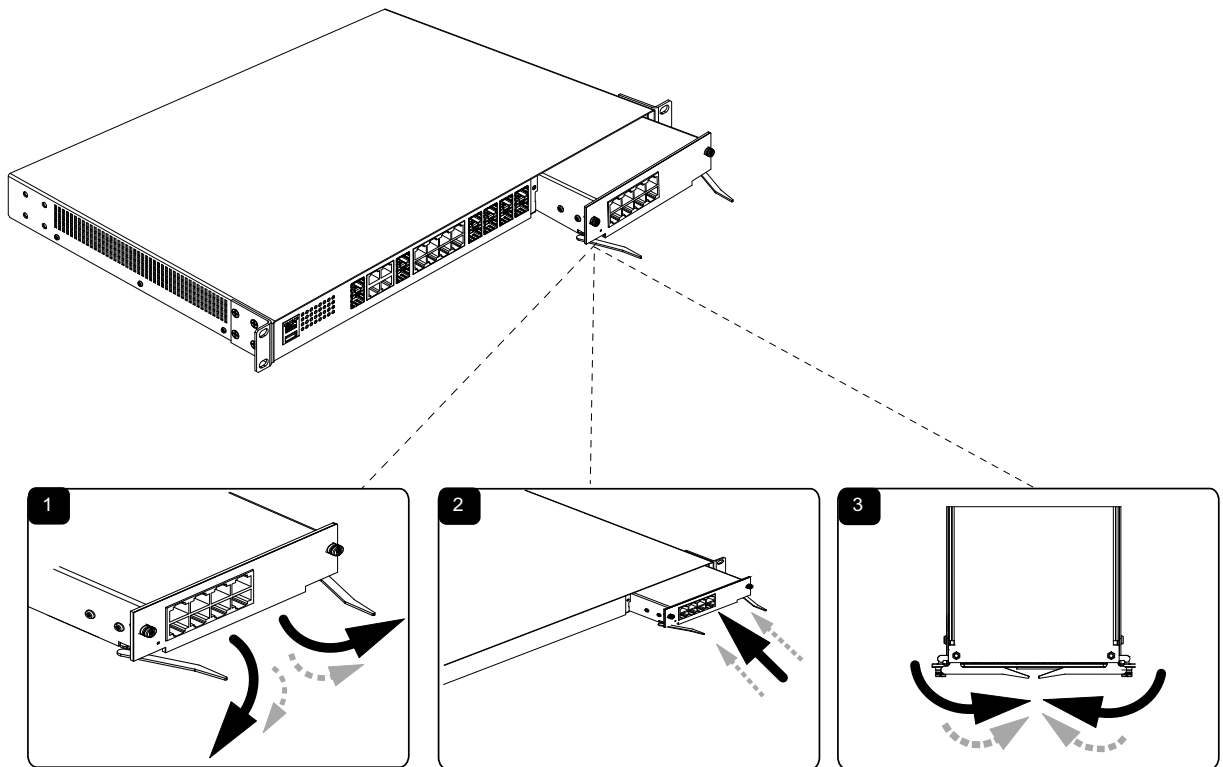

Figure 7: Mounting a media module

Proceed as follows:

- Remove the cover panel from the media module slot on the basic device.
- Open the lock of the media module by pressing the locking lever outwards (step 1).
- Insert the media module straight into the media module slot (step 2).
- Close the lock of the media module by pressing the locking lever inwards (step 3).
- Fasten the media module with the screws in the front panel of the basic device.

2.6 Operating the device

Relevant for North America:

The torque for tightening the supply voltage terminal block on the device is 4.5 lb-in (0.51 Nm).

The torque for tightening the terminal block for the signal contact on the device is 3 lb-in (0.34 Nm).

Proceed as follows:

- Use screws to secure the connectors to the device.
- Enable the supply voltage.

2.7 Connecting data cables

Note the following general recommendations for data cable connections in environments with high electrical interference levels:

- ▶ Keep the length of the data cables as short as possible.
- ▶ Use optical data cables for the data transmission between the buildings.
- ▶ When using copper cables, provide a sufficient separation between the power supply cables and the data cables. Ideally, install the cables in separate cable channels.
- ▶ Verify that power supply cables and data cables do not run parallel over longer distances, and that ideally they are installed in separate cable channels. If reducing the inductive coupling is necessary, verify that the power supply cables and data cables cross at a 90° angle.
- ▶ Use SF/UTP cables as per ISO/IEC 11801:2002.
- Connect the data cables according to your requirements.

For further information see [“Device name and product code” on page 16](#).

2.8 Filling out the inscription label

The information field for the MAC address on the front of the device helps you identify your device.

3 Making basic settings

Note: Two or more devices configured with the same IP address can cause unpredictable operation of your network.

Install and maintain a process that assigns a unique IP address to every device in the network.

The IP parameters must be entered when the device is installed for the first time. The device provides 6 options for configuring IP addresses:

- ▶ Entry via V.24 connection
- ▶ Entry using the HiDiscovery protocol via the application HiDiscovery or Industrial HiVision
- ▶ Configuration via BOOTP
- ▶ Configuration via DHCP
- ▶ Configuration via DHCP Option 82
- ▶ Auto Configuration Adapter

Further information on the basic settings of the device can be found in the user manual “Basic Configuration”.

■ **Default settings**

- ▶ IP address: The device looks for the IP address using DHCP
- ▶ Password for management:
 - Login: user; password: public (read only)
 - Login: admin; password: private (read and write)
- ▶ Parameters that can be set via the management are set to pre-defined values in accordance with the MIB
- ▶ V.24 data rate: 9,600 Baud
- ▶ Ring redundancy: disabled
- ▶ Ethernet ports: link status is not evaluated (signal contact)
- ▶ Optical 100 Mbit/s ports: 100 Mbit/s, full duplex
- ▶ All other ports: autonegotiation

4 Monitoring the ambient air temperature

Operate the device below the specified maximum ambient air temperature exclusively.

See [“General technical data” on page 46](#).

The ambient air temperature is the temperature of the air at a distance of 2 in (5 cm) from the device. It depends on the installation conditions of the device, e.g. the distance from other devices or other objects, and the output of neighboring devices.

5 Maintenance and service

- When designing this device, Hirschmann largely avoided using high-wear parts. The parts subject to wear and tear are dimensioned to last longer than the lifetime of the product when it is operated normally. Operate this device according to the specifications.
- Relays are subject to natural wear. This wear depends on the frequency of the switching operations. Check the resistance of the closed relay contacts and the switching function depending on the frequency of the switching operations.
- Hirschmann is continually working on improving and developing their software. Check regularly whether there is an updated version of the software that provides you with additional benefits. You find information and software downloads on the Hirschmann product pages on the Internet (www.hirschmann.com).
- Depending on the degree of pollution in the operating environment, check at regular intervals that the ventilation slots in the device are not obstructed.

You will find information about the complaints and returns procedures on the Internet under

<http://www.beldensolutions.com/en/Service/Repairs/index.phtml>.

6 Disassembly

6.1 Removing the device

WARNING

ELECTRIC SHOCK

Disconnect the grounding only after disconnecting all other cables.

Failure to follow these instructions can result in death, serious injury, or equipment damage.

Proceed as follows:

- To detach the device from the switch cabinet or the wall, remove the screws from the brackets on the device.

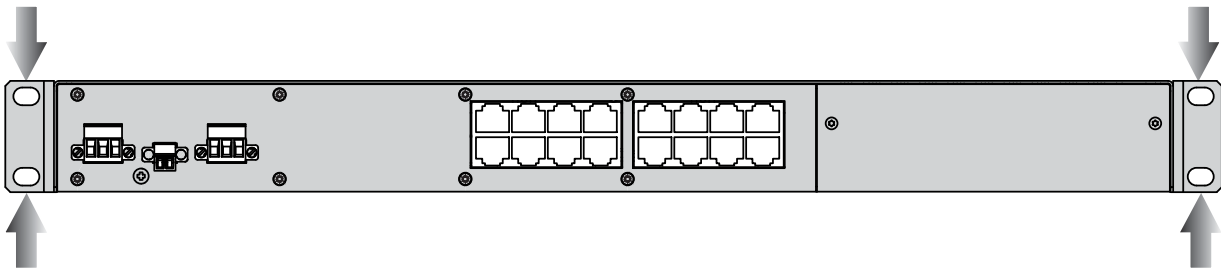

6.2 Removing an SFP transceiver (optional)

Proceed as follows:

- Pull the SFP transceiver out of the slot by means of the opened lock.



- Close the SFP transceiver with the protective cap.

6.3 Removing a media module (optional)

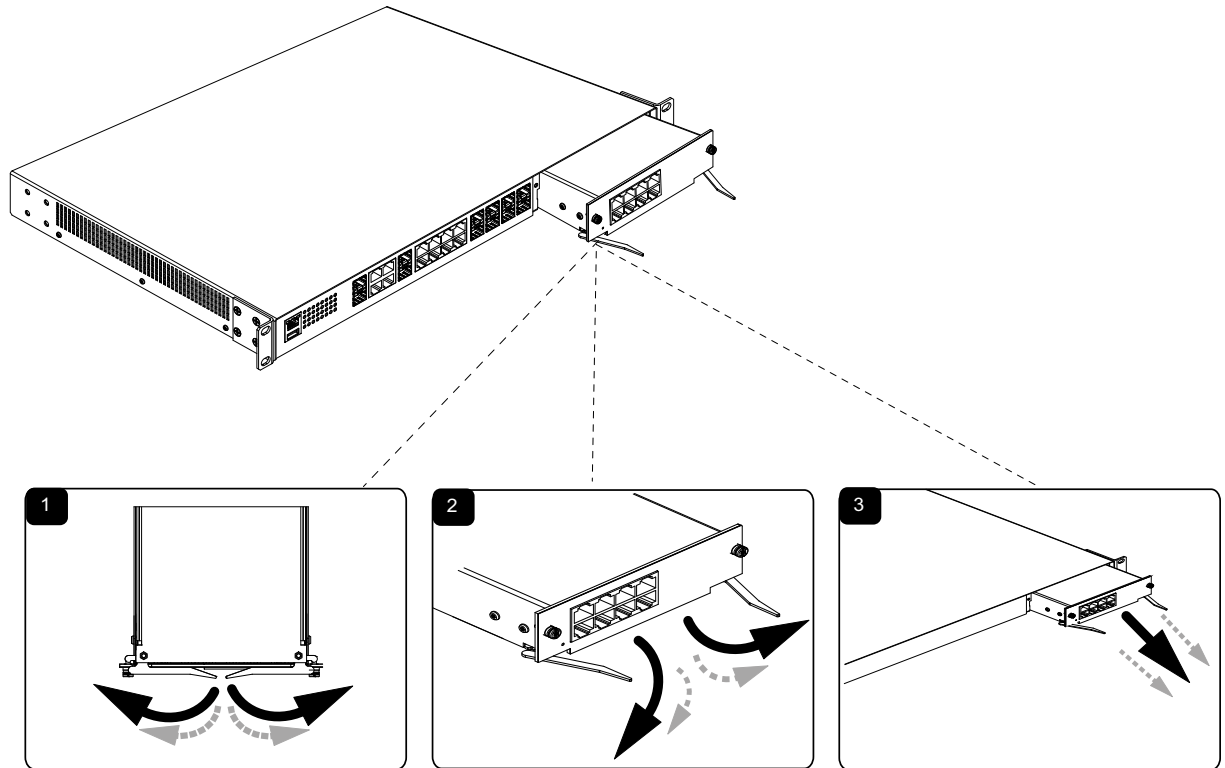

Figure 8: Demounting a media module

- Loosen the screws in the front panel of the media module.
- Open the lock of the media module by pressing the locking lever outwards (steps 1 and 2).
- Pull the media module out of the slot (step 3).
- Close the media module slot on the basic device using a cover panel.
- Fasten the cover panel using the 2 screws on the basic device.

7 Technical data

■ General technical data

Dimensions W × H × D	GRS1020-	17.64 in. × 12.40 in. × 1.73 in. (448 mm × 315 mm × 44 mm) (without brackets)	
	GRS1120-		
	GRS1030-		
	GRS1130-		
Weight Supply voltage with the characteristic value M	GRS1020-16T9	8.16 lb (3.7 kg)	
	GRS1120-16T9		
	GRS1030-16T9	8.38 lb (3.8 kg)	
	GRS1130-16T9		
	GRS1020-8T8Z	7.94 lb (3.6 kg)	
	GRS1120-8T8Z		
	GRS1030-8T8Z	8.16 lb (3.7 kg)	
	GRS1130-8T8Z		
	Optional second power unit	Additional 12.22 oz (380 g)	
Weight Supply voltage with the characteristic value C	GRS1020-16T9	8.38 lb (3.8 kg)	
	GRS1120-16T9		
	GRS1030-16T9	8.38 lb (3.8 kg)	
	GRS1130-16T9		
	GRS1020-8T8Z	7.94 lb (3.6 kg)	
	GRS1120-8T8Z		
	GRS1030-8T8Z	8.16 lb (3.7 kg)	
	GRS1130-8T8Z		
	Optional second power unit	Additional 13.83 oz (430 g)	
Power supply Supply voltage with the characteristic value M	Nominal voltage AC	110 V ... 240 V, 50 Hz ... 60 Hz	
	Voltage range AC incl. maximum tolerances	88 V ... 276 V	
	Connection type	3-pin terminal block	
	Nominal voltage DC	110 V ... 250 V	
	Voltage range DC incl. maximum tolerances:	88 V ... 288 V	
	Power loss buffer	> 20 ms at 230 V AC	
	Back-up fuse for each voltage input	Nominal rating:	2.5 A
		Characteristic:	slow blow
	Overload current protection at input	Non-replaceable fuse	
Peak inrush current	< 6 A		

Power supply Supply voltage with the characteristic value C	Nominal voltage DC	24 V ... 48 V	
	Voltage range DC incl. maximum tolerances	18 V ... 60 V	
	Connection type	2-pin terminal block	
	Power loss buffer	> 10 ms at 20.4 V DC	
	Back-up fuse for each voltage input	Nominal rating: 6.3 A Characteristic: slow blow	
	Overload current protection at input	Non-replaceable fuse	
	Peak inrush current	< 7 A	
Signal contact	Nominal value for AC	$I_{\max} = 2 \text{ A}$ at $U_{\max} = 230 \text{ V}$	
	Nominal value for DC	$I_{\max} = 2 \text{ A}$ at $U_{\max} = 30 \text{ V}$ $I_{\max} = 0.2 \text{ A}$ at $U_{\max} = 125 \text{ V}^a$ $I_{\max} = 0.1 \text{ A}$ at $U_{\max} = 250 \text{ V}^a$	
Climatic conditions during operation	Ambient air temperature ^b	Standard	
		up to 6562 ft ASL (2000 m ASL)	+32 °F ... +140 °F (0 °C ... +60 °C)
		above 6562 ft ASL (2000 m ASL)	+32 °F to +122 °F (0 °C ... +50 °C)
		Extended ^{c, d, e}	
		up to 6562 ft ASL (2000 m ASL)	-40 °F ... +158 °F (-40 °C ... +70 °C)
		above 6562 ft ASL (2000 m ASL)	-40 °F ... +140 °F (-40 °C ... +60 °C)
		Extended with conformal coating ^{b, c}	
above 6562 ft ASL (2000 m ASL)	-40 °F ... +158 °F (-40 °C ... +70 °C)		
above 6562 ft ASL (2000 m ASL)	-40 °F ... +140 °F (-40 °C ... +60 °C)		
	Humidity	5 % ... 95 % (non-condensing)	
	Air pressure	at least 600 hPa (+13123 ft; +4000 m) maximum 1060 hPa (-1312 ft; -400 m)	
Climatic conditions during storage	Ambient air temperature ^a	-40 °F ... +185 °F (-40 °C ... +85 °C)	
	Humidity	5 % ... 95 % (non-condensing)	
	Air pressure	at least 600 hPa (+13123 ft; +4000 m) maximum 1060 hPa (-1312 ft; -400 m)	
Pollution degree		2	
Protection classes	Laser protection	Class 1 in compliance with IEC 60825-1	
	Degree of protection	IP20	

a. Not UL 60950 certified.

b. Temperature of the ambient air at a distance of 2 inches (5 cm) from the device

c. If you are using SFP modules without the "EEC" extension, an operating temperature of +32 °F to +140 °F (0 °C to +60 °C) applies for your device. See "Accessories" on page 54.

d. Applies to device variants GRS....-8T8Z... with the extended temperature range:

e. If more than 4 SFP transceivers are used, the maximum operating temperature is reduced by 2 K per additional SFP transceiver.

■ Dimension drawings

mm
inch

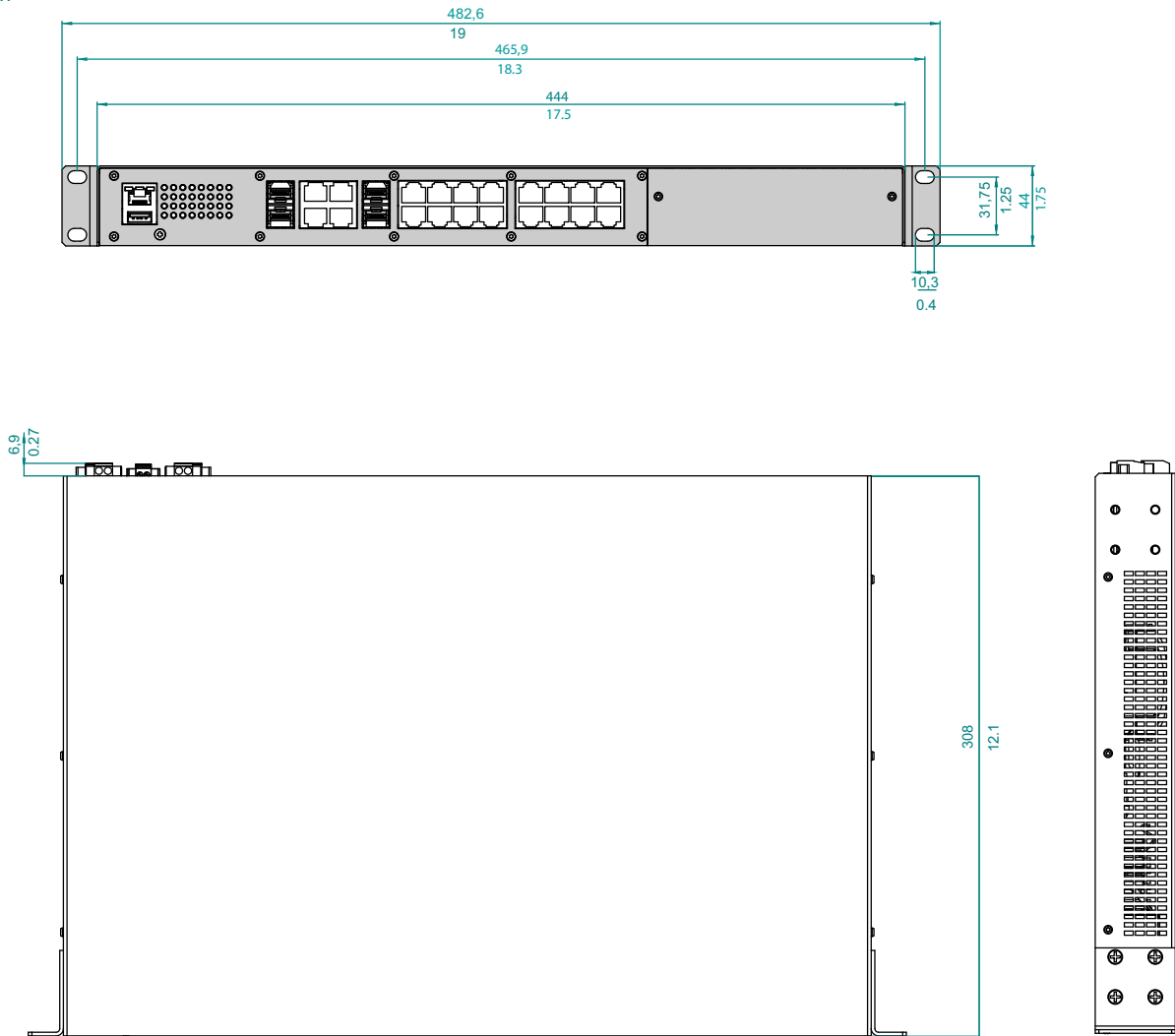

Figure 9: Dimensions of the device variant GRS1030

■ EMC and immunity

EMC interference emission		Standard applications ^a	Merchant Navy ^b	Railway applications (trackside) ^c	Substation applications ^d
Radiated emission					
EN 55022		Class A	Class A	Class A	Class A
DNV GL Guidelines		—	EMC 1	—	—
FCC 47 CFR Part 15		Class A	Class A	Class A	Class A
EN 61000-6-4		Fulfilled	Fulfilled	Fulfilled	Fulfilled
Conducted emission					
EN 55022	DC supply connection	Class A	Class A	Class A	Class A
DNV GL Guidelines	DC supply connection	—	EMC 1	—	—
FCC 47 CFR Part 15	DC supply connection	Class A	Class A	Class A	Class A
EN 61000-6-4	DC supply connection	Fulfilled	Fulfilled	Fulfilled	Fulfilled
EN 55022	Telecommunication connections	Class A	Class A	Class A	Class A
EN 61000-6-4	Telecommunication connections	Fulfilled	Fulfilled	Fulfilled	Fulfilled

a. EN 61131-2, CE, FCC – applies to all devices

b. Merchant Navy – applies to devices with the approval codes U9, UT, UX, UY, VU

c. EN 50121-4 – applies to devices with the certification codes VT, T9, TY

d. EN 61850-3, IEEE 1613 – applies to devices with the certification codes V9, VY, VU, VT

EMC interference immunity		Standard applications ^a	Merchant Navy ^b	Railway applications (trackside) ^c	Substation applications ^d
Electrostatic discharge					
EN 61000-4-2 IEEE C37.90.3	Contact discharge	± 4 kV	± 6 kV	± 6 kV	± 8 kV
EN 61000-4-2 IEEE C37.90.3	Air discharge	± 8 kV	± 8 kV	± 8 kV	± 15 kV
Electromagnetic field					
EN 61000-4-3 IEEE 1613	80 MHz ... 3000 MHz	10 V/m	10 V/m	20 V/m	10 V/m
	80 MHz ... 1000 MHz	—	—	—	35 V/m
Fast transients (burst)					
EN 61000-4-4 IEEE C37.90.1	DC supply connection	± 2 kV	± 2 kV	± 2 kV	± 4 kV
EN 61000-4-4 IEEE C37.90.1	Data line	± 4 kV	± 4 kV	± 2 kV	± 4 kV
Voltage surges - DC supply connection					
EN 61000-4-5 IEEE 1613	line/ground	± 2 kV	± 2 kV	± 2 kV	± 2 kV
	line/ground	—	—	—	± 5 kV
EN 61000-4-5	line/line	± 1 kV	± 1 kV	± 1 kV	± 1 kV
Voltage surges - data line					
EN 61000-4-5	line/ground	± 1 kV	± 1 kV	± 2 kV	± 2 kV
Conducted disturbances					
EN 61000-4-6	150 kHz ... 80 MHz	10 V	10 V	10 V	10 V

EMC interference immunity		Standard applications ^a	Merchant Navy ^b	Railway applications (trackside) ^c	Substation applications ^d
Damped vibration – DC supply connection					
EN 61000-4-12 IEEE C37.90.1	line/ground	—	—	—	2.5 kV
EN 61000-4-12 IEEE C37.90.1	line/line	—	—	—	1 kV
Damped oscillation - data line					
EN 61000-4-12 IEEE C37.90.1	line/ground	—	—	—	2.5 kV
EN 61000-4-12	line/line	—	—	—	± 1 kV
Pulse magnetic fields					
EN 61000-4-9		—	—	300 A/m	—

- a. EN 61131-2, CE, FCC – applies to all devices
- b. Merchant Navy – applies to devices with the approval codes U9, UT, UX, UY, VU
- c. EN 50121-4 – applies to devices with the certification codes VT, T9, TY
- d. EN 61850-3, IEEE 1613 – applies to devices with the certification codes V9, VY, VU, VT

Stability		Standard applications ^a	Merchant Navy ^b	Railway applications (trackside) ^c	Substation applications ^d
IEC 60068-2-6, test Fc	Vibration	5 Hz ... 8.4 Hz with 0.14 in. (3.5 mm) amplitude 8.4 Hz ... 150 Hz with 1 g —	2 Hz ... 13.2 Hz with 0.04 in. (1 mm) amplitude 13.2 Hz ... 200 Hz with 0.7 g —	— — —	2 Hz ... 9 Hz with 0.12 in. (3 mm) amplitude 9 Hz ... 200 Hz with 1 g 200 Hz ... 500 Hz with 1.5 g
IEC 60068-2-27, test Ea	Shock	15 g at 11 ms	—	—	10 g at 11 ms

- a. EN 61131-2, CE, FCC – applies to all devices
- b. Merchant Navy – applies to devices with the approval codes U9, UT, UX, UY, VU
- c. EN 50121-4 – applies to devices with the certification codes VT, T9, TY
- d. EN 61850-3, IEEE 1613 – applies to devices with the certification codes V9, VY, VU, VT

■ Network range

Note: The line lengths specified for the transceivers apply for the respective fiber data (fiber attenuation and BLP/dispersion).

Product code M-SFP-...	Wave length	Fiber	System attenuation	Example for F/O line length ^a	Fiber attenuation	BLP ^b /dispersion
-SX/LC...	MM 850 nm	50/125 μm	0-7.5 dB	0-550 m	3.0 dB/km	400 MHz×km
-SX/LC...	MM 850 nm	62.5/125 μm	0-7.5 dB	0-275 m	3.2 dB/km	200 MHz×km
-MX/LC	MM 1310 nm	50/125 μm	0-8 dB	2 km ^c	1.0 dB/km	500 MHz×km
-MX/LC	MM 1310 nm	62.5/125 μm	0-8 dB	1 km	1.0 dB/km	500 MHz×km
-LX/LC...	MM 1310 nm ^d	50/125 μm	0-10.5 dB	0-550 m	1.0 dB/km	800 MHz×km
-LX/LC...	MM 1310 nm ^c	62.5/125 μm	0-10.5 dB	0-550 m	1.0 dB/km	500 MHz×km
-LX/LC...	SM 1310 nm	9/125 μm	0-10.5 dB	0-20 km ^e	0.4 dB/km	3.5 ps/(nm×km)
-LX+/LC...	SM 1310 nm	9/125 μm	5-20 dB	14-42 km	0.4 dB/km	3.5 ps/(nm×km)
-LH/LC...	LH 1550 nm	9/125 μm	5-22 dB	23-80 km	0.25 dB/km	19 ps/(nm×km)
-LH+/LC	LH 1550 nm	9/125 μm	15-30 dB	71-108 km	0.25 dB/km	19 ps/(nm×km)
-LH+/LC	LH 1550 nm	9/125 μm	15-30 dB	71-128 km	0.21 dB/km (typically)	19 ps/(nm×km)

Table 15: Fiber port 1000BASE-FX (SFP fiber optic Gigabit Ethernet Transceiver)

- a. including 3 dB system reserve when compliance with the fiber data is observed
- b. Using the bandwidth length product is inappropriate for expansion calculations.
- c. Distances of up to 3 km can be reached, 1000 MHz×km (1300 nm)
- d. With F/O adapter compliant with IEEE 802.3-2002 clause 38 (single-mode fiber offset-launch mode conditioning patch cord)
- e. Including 2.5 dB system reserve when compliance with the fiber data is observed

Product code M-SFP-BIDI...	Wave length TX	Wave length RX	Fiber	System attenuation	Example for F/O line length ^a	Fiber attenuation	Dispersion
Type A LX/LC EEC	SM 1310 nm	1550 nm	9/125 μm	0-11 dB	0-20 km	0.4 dB/km	3.5 ps/(nm×km)
Type B LX/LC EEC	SM 1550 nm	1310 nm	9/125 μm	0-11 dB	0-20 km	0.25 dB/km	19 ps/(nm×km)
Type A LH/LC EEC	LH 1490 nm	1590 nm	9/125 μm	5-24 dB	23-80 km	0.25 dB/km	19 ps/(nm×km)
Type B LH/LC EEC	LH 1590 nm	1490 nm	9/125 μm	5-24 dB	23-80 km	0.25 dB/km	19 ps/(nm×km)

Table 16: F/O port (bidirectional Gigabit Ethernet SFP Transceiver)

- a. including 3 dB system reserve when compliance with the fiber data is observed

Product code M-FAST-SFP-...	Wave length	Fiber	System attenuation	Example for F/O line length ^a	Fiber attenuation	BLP/dispersion
-MM/LC...	MM	1310 nm	50/125 µm	0-8 dB	0-5 km	1.0 dB/km 800 MHz×km
-MM/LC...	MM	1310 nm	62.5/125 µm	0-11 dB	0-4 km	1.0 dB/km 500 MHz×km
-SM/LC...	SM	1310 nm	9/125 µm	0-13 dB	0-25 km	0.4 dB/km 3.5 ps/(nm×km)
-SM+/LC...	SM	1310 nm	9/125 µm	10-29 dB	25-65 km	0.4 dB/km 3.5 ps/(nm×km)
-LH/LC...	SM	1550 nm	9/125 µm	10-29 dB	47-104 km	0.25 dB/km 19 ps/(nm×km)
-LH/LC...	SM	1550 nm	9/125 µm	10-29 dB	55-140 km	0.18 dB/km ^b 18 ps/(nm×km)

Table 17: Fiber port 100BASE-FX (SFP fiber optic Fast Ethernet Transceiver)

- a. including 3 dB system reserve when compliance with the fiber data is observed
b. with ultra-low-loss optical fiber

10/100/1000 Mbit/s twisted pair port

Length of a twisted pair segment max. 109 yards (100 m) (for Cat5e cable)

■ Power consumption/power output, order numbers

The order numbers correspond to the product codes of the devices.

Name	Characteristic value	Maximum power consumption	Power output
Grundgeräte^a			
GRS1020-16T9...	M	7.5 W	26 Btu (IT)/h
GRS1120-16T9...		7.5 W	26 Btu (IT)/h
GRS1030-16T9...		10.5 W	36 Btu (IT)/h
GRS1130-16T9...		10.5 W	36 Btu (IT)/h
GRS1020-8T8Z...		12 W	41 Btu (IT)/h
GRS1120-8T8Z...		12 W	41 Btu (IT)/h
GRS1030-8T8Z...		16 W	55 Btu (IT)/h
GRS1130-8T8Z...		16 W	55 Btu (IT)/h
GRS1020-16T9...	C	9 W	31 Btu (IT)/h
GRS1120-16T9...		9 W	31 Btu (IT)/h
GRS1030-16T9...		12 W	41 Btu (IT)/h
GRS1130-16T9...		12 W	41 Btu (IT)/h
GRS1020-8T8Z...		15.5 W	53 Btu (IT)/h
GRS1120-8T8Z...		15.5 W	53 Btu (IT)/h
GRS1030-8T8Z...		18 W	61 Btu (IT)/h
GRS1130-8T8Z...		18 W	61 Btu (IT)/h
Media modules			
GRM20-TTTTTTTT...		2 W	7 Btu (IT)/h
GRM20-XXXXTTTT... ^b		7.5 W	26 Btu (IT)/h
GRM20-XXXXXXXX... ^b		9 W	31 Btu (IT)/h

- a. for redundant supply voltage with characteristic value M: +4 BTU (IT)/h
for redundant supply voltage with characteristic value C: +10 BTU (IT)/h
b. X = M, N, U, V or Z

■ Scope of delivery

Number	Article
1 ×	Device
1 ×	2-pin terminal block for signal contact
1 ×	3-pin terminal block for the supply voltage (only for device variants featuring supply voltage with the characteristic value M9)
2 ×	3-pin terminal block for the supply voltage (only for device variants featuring supply voltage with the characteristic value MM)
1 ×	2-pin terminal block for the supply voltage (only for device variants featuring supply voltage with the characteristic value C9)
2 ×	2-pin terminal block for the supply voltage (only for device variants featuring supply voltage with the characteristic value CC)
2 ×	Bracket
1 ×	General safety instructions

■ Accessories

Note: Note that products recommended as accessories may have characteristics that do not fully correspond to those of the respective product. This may limit their possible usage in the overall system.

Gigabit Ethernet SFP transceiver	Order number
M-SFP-TX/RJ45	943 977-001
M-SFP-TX/RJ45 EEC	942 161-001

The following operating conditions apply to twisted pair transceivers:

- ▶ Usable with:
 - HiOS as of software version 03.0.00
 - Classic Switch software, as of software version 04.1.00.
 - HiSecOS as of software version 01.2.00
- Do not use with the following devices:
 - SPIDER II- MSP/MSM
 - EES
- ▶ Longer RSTP switching times and link loss detection times compared to twisted pair ports provided by the device directly.
- ▶ Not applicable for combo and Fast Ethernet ports.
- ▶ Only support of the autonegotiation mode including autocrossing.

M-SFP-SX/LC	943 014-001
M-SFP-SX/LC EEC	943 896-001
M-SFP-MX/LC EEC	942 108-001
M-SFP-LX/LC	943 015-001
M-SFP-LX/LC EEC	943 897-001
M-SFP-LX+/LC	942 023-001
M-SFP-LX+/LC EEC	942 024-001
M-SFP-LH/LC	943 042-001
M-SFP-LH/LC EEC	943 898-001
M-SFP-LH+/LC	943 049-001
M-SFP-LH+/LC EEC	942 119-001
SFP-GIG-LX/LC ^a	942 196-001

Gigabit Ethernet SFP transceiver	Order number
SFP-GIG-LX/LC EEC ^a	942 196-002

- a. You find further information on certifications on the Internet at the Hirschmann product pages (www.hirschmann.com).

Bidirectional Gigabit Ethernet SFP transceiver	Order number
M-SFP-BIDI Type A LX/LC EEC	943 974-001
M-SFP-BIDI Type B LX/LC EEC	943 974-002
M-SFP-BIDI Type A LH/LC EEC	943 975-001
M-SFP-BIDI Type B LH/LC EEC	943 975-002
M-SFP-BIDI Bundle LX/LC EEC (type A + B)	943 974-101
M-SFP-BIDI Bundle LH/LC EEC (type A + B)	943 975-101

Fast Ethernet SFP transceiver	Order number
M-FAST SFP-TX/RJ45	942 098-001
M-FAST SFP-TX/RJ45 EEC	942 098-002

The following operating conditions apply to twisted pair transceivers:

- ▶ Usable with:
 - HiOS as of software version 03.0.00
 - for PRP ports on RSP devices, as of software version 02.0.01
 - for PRP ports on EES devices, as of software version 02.0.02
 - Classic switch software as of software version 08.0.00
 - HiSecOS as of software version 01.2.00
- ▶ Longer RSTP switching times and link loss detection times compared to twisted pair ports provided by the device directly.
- ▶ Not applicable for combo ports.
- ▶ Not applicable for ports which support only Gigabit Ethernet.
- ▶ To set autocrossing manually is currently not possible.

M-FAST SFP-MM/LC	943 865-001
M-FAST SFP-MM/LC EEC	943 945-001
M-FAST SFP-SM/LC	943 866-001
M-FAST SFP-SM/LC EEC	943 946-001
M-FAST SFP-SM+/LC	943 867-001
M-FAST SFP-SM+/LC EEC	943 947-001
M-FAST SFP-LH/LC	943 868-001
M-FAST SFP-LH/LC EEC	943 948-001
SFP-FAST-MM/LC ^a	942 194-001
SFP-FAST-MM/LC EEC ^a	942 194-002
SFP-FAST-SM/LC ^a	942 195-001
SFP-FAST-SM/LC EEC ^a	942 195-002

- a. You find further information on certifications on the Internet at the Hirschmann product pages (www.hirschmann.com).

Other accessories	Order number
AutoConfiguration Adapter ACA21-USB (EEC)	943 271-003
AutoConfiguration Adapter ACA22-USB (EEC)	942 124-001
Terminal cable: RJ45 on Sub-D, 9-pin	942 097-001

Other accessories	Order number
Terminal cable: RJ45 on USB	942 096-001
3-pin High Voltage Interlock terminal block (50 pcs.)	943 845-008
2-pin Low Voltage Interlock terminal block (50 pcs.)	943 845-010
Bracket for fastening the housing	943 943-001
Dust protection cap (50 pieces) for RJ45 sockets	943 936-001
Dust protection cap (25 pieces) for SFP slot	943 942-001
Network management software Industrial HiVision	943 156-xxx

■ Underlying technical standards

Name	
ANSI/ ISA 12.12.01	Nonincendive Electrical Equipment for Use in Class I and II, Division 2, and Class III, Divisions 1 and 2 Hazardous (Classified)Locations
CSA C22.2 No. 142	Canadian National Standard(s) – Process Control Equipment – Industrial Products
EN 50121-4	Railway applications – EMC – Emission and immunity of the signaling and telecommunications apparatus (Rail Trackside)
EN 55022	Information technology equipment – Radio disturbance characteristics – Limits and methods of measurement
EN 60950-1	Information technology equipment – Safety – Part 1: General requirements
EN 61000-3-2	Electromagnetic compatibility (EMC) - Part 3-2: Limits - Limits for harmonic current emissions
EN 61000-3-3	Electromagnetic compatibility (EMC) - Part 3-3: Limits - Limitation of voltage changes, voltage fluctuations and flicker.
EN 61000-6-2	Electromagnetic compatibility (EMC) – Part 6-2: Generic standards – Immunity for industrial environments
EN 61000-6-4	Electromagnetic compatibility (EMC) – Part 6-4: Generic standards – Emission standard for industrial environments
EN 61131-2	Programmable controllers – Part 2: Equipment requirements and tests
IEC/EN 61850-3	Communication networks and systems in substations – Part 3: General requirements
FCC 47 CFR Part 15	Code of Federal Regulations
DNVGL-CG-0339	Environmental test specification for electrical, electronic and programmable equipment and systems.
IEEE 1613	Standard Environment and Testing Requirements for Communication Networking Devices in Electric Power Substations
IEEE 802.3	Ethernet
NEMA TS 2	Traffic Controller Assemblies with NTCIP Requirements (environmental requirements)

Table 18: List of the technical standards

The device generally fulfills the technical standards named in their current versions.

The device has an approval based on a specific standard only if the approval indicator appears on the device casing.

If your device has a shipping approval according to DNV GL, you find the approval mark printed on the device label. You will find out whether your device has other shipping approvals on the Hirschmann website under www.hirschmann.com in the product information.

A Further Support

Technical Questions

For technical questions, please contact any Hirschmann dealer in your area or Hirschmann directly.

You will find the addresses of our partners on the Internet at <http://www.hirschmann.com>.

A list of local telephone numbers and email addresses for technical support directly from Hirschmann is available at <https://hirschmann-support.belden.eu.com>.

This site also includes a free of charge knowledge base and a software download section.

Hirschmann Competence Center

The Hirschmann Competence Center is ahead of its competitors:

- ▶ Consulting incorporates comprehensive technical advice, from system evaluation through network planning to project planning.
- ▶ Training offers you an introduction to the basics, product briefing and user training with certification.
The current technology and product training courses can be found at <http://www.hicomcenter.com>
- ▶ Support ranges from the first installation through the standby service to maintenance concepts.

With the Hirschmann Competence Center, you have decided against making any compromises. Our client-customized package leaves you free to choose the service components you want to use.

Internet:

<http://www.hicomcenter.com>



HIRSCHMANN

A **BELDEN** BRAND