

dimensions **∅ 9mm**

round cylinders mounting clip
profile cylinders clamp

- ✓ **robust metal housing (impact- and vibration-resistant)**
- ✓ **simple mounting, even with very short cylinders**
- ✓ **high switching accuracy with small hysteresis**
- ✓ **LED display**
- ✓ **integrated amplifier**
- ✓ **connection via cable, M8- or M12-connector**

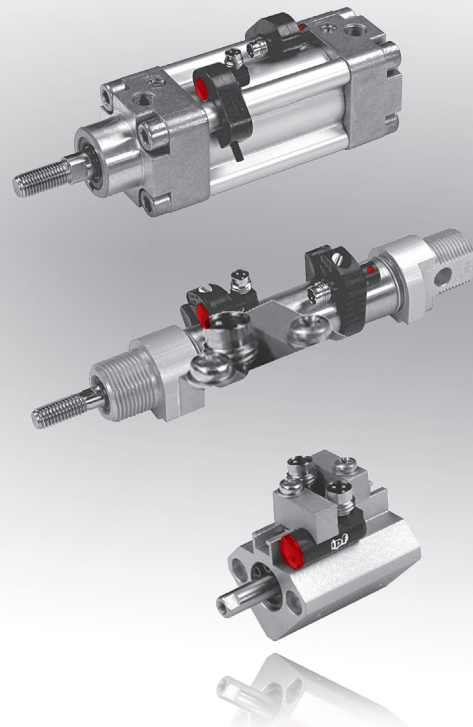

for use on profile cylinders and round cylinders

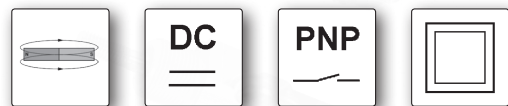

description

For many tasks in automation technology, it is necessary to detect movements in pneumatic cylinders and to precisely detect the position of the piston. Available for selection are both fully electronic sensors as well as reed sensors. Under certain operating conditions, e.g., in the case of strong vibrations, high switching frequencies and high requirements for exact switching points, reed switches have application limits. The lack of short-circuit protection, the high sensitivity in the event of inductive voltage spikes and, in particular, the wear of the switching contacts are frequent causes of problems in practical use. Due to these shortcomings, industry demanded sensors that guarantee long-term and fault-free operation and thereby

avoid machine stoppages and the associated production losses. For this purpose, *ipf electronic* offers magnetic cylinder sensors that are used for the position detection of the piston position in pneumatic cylinders. Through the absolute wear-free mode of operation, they ensure maximum operational dependability and reliability. The electronic cylinder sensors can be used on cylinders from all leading manufacturers.

application examples

- ▶ position detection of a cylinder piston
- ▶ end position sensing

article-no.	MZR90120	MZR90179	MZR90185	MZR901A8
connection	M12-cable connector	M8-connector	M8-connector 90°	2m cable
TECHNICAL DATA				
sensor surface (active)	middle area	middle area	middle area	middle area
output signal	pnp, no	pnp, no	pnp, no	pnp, no
operating voltage	10 ... 30V DC	10 ... 30V DC	10 ... 30V DC	10 ... 30V DC
current consumption (w/o load)	≤ 15mA	≤ 15mA	≤ 15mA	≤ 15mA
output current (max. load)	150mA	200mA	200mA	150mA
voltage drop (max. load)	2.0V DC	2.0V DC	2.0V DC	2.0V DC
switching hysteresis	typ. 1mm	typ. 1mm	typ. 1mm	typ. 1mm
repeatability	±0.1mm	±0.1mm	±0.1mm	±0.1mm
switching frequency	1kHz	1kHz	1kHz	1kHz
display (signal)	yellow LED	yellow LED	yellow LED	yellow LED
short-circuit protection	+	+	+	+
reverse polarity protection	+	+	+	+
housing material	stainl. steel	stainl. steel	stainl. steel	stainl. steel
dimensions	∅ 9x22mm	∅ 9x29mm	∅ 9x22mm	∅ 9x22mm
operating temperature	-25 ... +75°C	-25 ... +75°C	-25 ... +75°C	-25 ... +75°C
degree of protection (EN 60529)	IP67	IP67	IP67	IP67
connection	M12-cable connector, 3-pin	M8-connector, 3-pin	M8-connector, 3-pin 90°	2m cable, PUR, 3-wire
connection accessories	e.g. VK200025	e.g. VK200075	e.g. VK200075	-
mounting accessories	e.g. AM000011	e.g. AM000011	e.g. AM000011	e.g. AM000011

connection

cable device

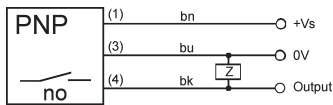

connector device

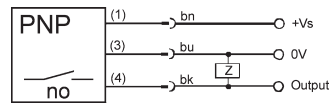

wire colors: bn = brown (1), bu = blue (3), bk = black (4)

cable connector with rotatable outside thread

ACCESSORIES mounting clip for MZR9

article-no.	for piston \varnothing	B1	B2	B3	H1	H2	H3	housing material
AM000011	\varnothing 8mm	21	-	14	23.5	16.5	9	plastic
AM000012	\varnothing 10mm	22	0.5	14	26	18.5	10	plastic
AM000013	\varnothing 12mm	22	4	11	28.5	20	10.2	plastic
AM000014	\varnothing 16mm	22.5	4	11.5	33.5	22.5	12.4	plastic
AM000015	\varnothing 20mm	26.5	5.5	13.5	35.5	22.5	14	plastic
AM000016	\varnothing 25mm	31.5	7.5	16	40.5	25	16	plastic
AM000047	\varnothing 32mm	38.6	7.9	-	47.8	29	19.7	plastic
AM000048	\varnothing 40mm	46.6	8.1	-	55.8	33	23.8	plastic

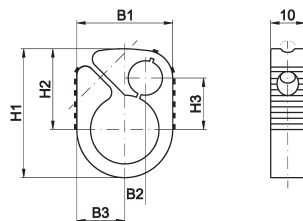

ACCESSORIES mounting clip for MZR9

article-no.	for piston \varnothing	Rmax	B	housing material
AM000023	\varnothing 32mm	29	10	plastic
AM000024	\varnothing 40mm	32	10	plastic
AM000025	\varnothing 50mm	38	10	plastic
AM000026	\varnothing 63mm	46	10	plastic
AM000027	\varnothing 80mm	54	12	plastic
AM000028	\varnothing 100mm	64	12	plastic

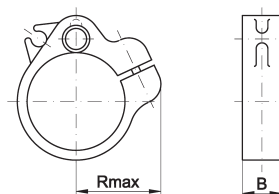

ACCESSORIES twin clip for MZR9

article-no.	for piston \varnothing	S	T	housing material
AM000029	\varnothing 8/10mm	27.4	19.6	plastic/stainl. steel
AM000030	\varnothing 12mm	28.5	21.4	plastic/stainl. steel
AM000031	\varnothing 16mm	29.4	23.4	plastic/stainl. steel
AM000032	\varnothing 20mm	29.7	28.8	plastic/stainl. steel
AM000033	\varnothing 25mm	31.4	28.7	plastic/stainl. steel

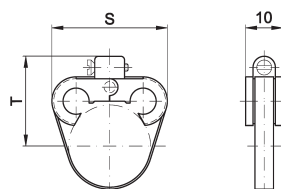

ACCESSORIES clamp for MZR9

article-no.	description	housing material
AM000021	for cylinder rails up to 12mm \varnothing	zinc
AM000022	for cylinder rails up to 14mm \varnothing	zinc

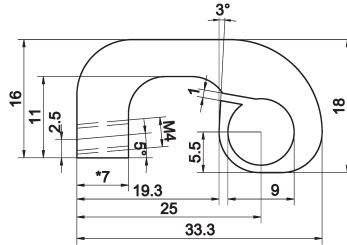

ACCESSORIES clip for MZR9

article-no.	description	comment	housing material
AM000053	accessories clip 1	mounting MZR9 on SMC cylinders	aluminum
AM000054	accessories clip 2	mounting MZR9 on SMC cylinders	aluminum

clip 1

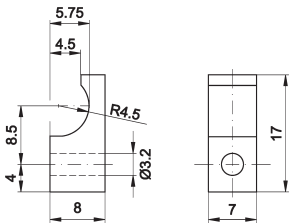

clip 2

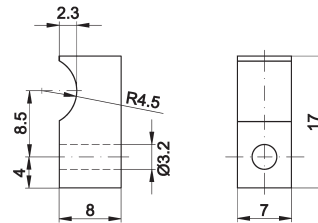

This data sheet only contains the available standard variants. For other output / connection variants, we kindly ask that you contact us.

We are happy to supply the right cable socket for the plug equipment. You will find a list in the "accessories" section of the catalog under **ipf-SENSORFLEX**® "cable sockets" or in the search window on our homepage www.ipf-electronic.com (using the search term "VK").

Warning: Never use these devices in applications where the safety of a person depends on their functionality.

This data sheet as well as your personal contact can be found at www.ipf-electronic.com