

flush, non-flush

NOTES

A large grid area for taking notes, consisting of a 20x30 grid of small squares. The grid is empty and occupies the majority of the page.

dimensions
M8 x 1
M12 x 1
M18 x 1
Ø 20
M30 x 1.5
Ø 34
Ø 80
Ø 100

flush switching distance **up to 25mm**
non-flush switching distance **up to 120mm**

- ✓ metal sleeve made of stain. steel; nickel-plated brass or plastic housing
- ✓ LED indicator for signal
- ✓ integrated amplifier
- ✓ high switching frequency and switching distances
- ✓ connection via cable, M8- or M12-connector

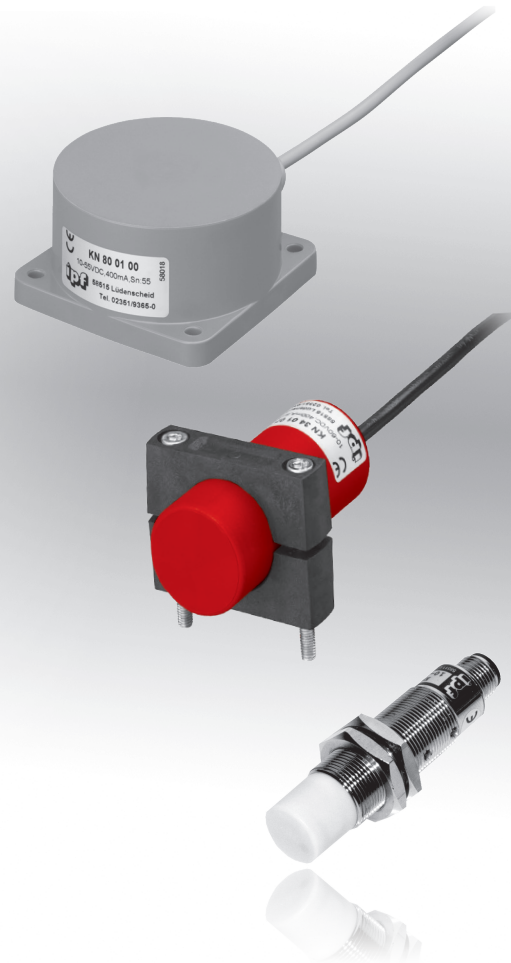

Switching distance adjustable with potentiometer

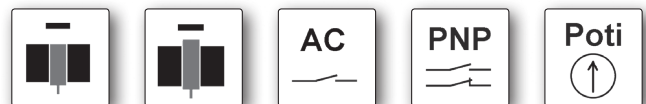

description

The function of a capacitive sensor is based on the change of the electric field in the area in front of its active zone. The sensor operates with an oscillator. The capacitance between the active electrode and the electric ground potential is measured. As a metallic or non-metallic material enters the active zone of the sensor, the capacitance increases and thereby influences the oscillation amplitude of the oscillator.

As a result, the trigger stage downstream of the oscillator flips, thereby causing the switching amplifier in the sensor to change its output status.

All sensors are provided with a potentiometer by means of which the desired switching distance can be set. These capacitive sensors are used for the detection of objects, for counting

tasks and for all types of filling level monitoring of solid materials (e.g., powder, granulate, pellets, etc.) and liquid materials (e.g., water, oil, hot glue, pastes, acids, etc.).

application examples

- ▶ integration in machine parts subject to rough industrial environments
- ▶ checking the presence of metal parts with various dimensions
- ▶ detecting object heights, e.g. metal parts on conveyor belts
- ▶ detection of objects through the walls of non-metallic containers and tubes

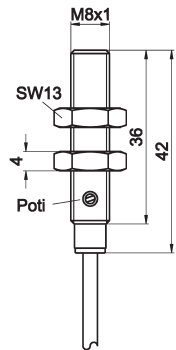
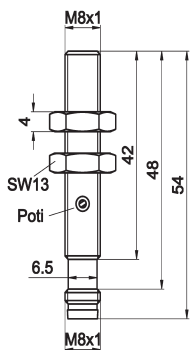
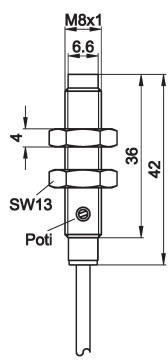
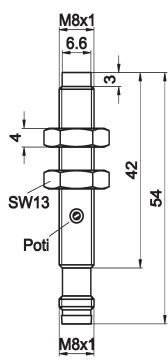

article-no.	KB080100	KB080170	KN080100	KN080170
switching distance	0.1 ... 1.5mm	0.1 ... 1.5mm	0.1 ... 3.0mm	0.1 ... 3.0mm
output signal	pnp, no	pnp, no	pnp, no	pnp, no
mounting	flush	flush	non-flush	non-flush
connection	cable	M8-connector	cable	M8-connector
				
TECHNICAL DATA				
switching distance	0.1 ... 1.5mm	0.1 ... 1.5mm	0.1 ... 3.0mm	0.1 ... 3.0mm
output signal	pnp, no	pnp, no	pnp, no	pnp, no
operating voltage	11 ... 30V DC	11 ... 30V DC	11 ... 30V DC	11 ... 30V DC
current consumption (w/o load)	≤ 15mA	≤ 15mA	≤ 15mA	≤ 15mA
output current (max. load)	50mA	50mA	50mA	50mA
voltage drop (max. load)	2.0V DC	2.0V DC	2.0V DC	2.0V DC
hysteresis	5 ... 15%	5 ... 15%	5 ... 15%	5 ... 15%
switching frequency	100Hz	100Hz	100Hz	100Hz
correction factors	wood, glass approx. 0.6 oil, PVC approx. 0.5	wood, glass approx. 0.6 oil, PVC approx. 0.5	wood, glass approx. 0.6 oil, PVC approx. 0.5	wood, glass approx. 0.6 oil, PVC approx. 0.5
display	yellow LED	yellow LED	yellow LED	yellow LED
short-circuit protection	+	+	+	+
reverse polarity protection	+	+	+	+
sensitivity adjustment	potentiometer	potentiometer	potentiometer	potentiometer
dimensions	M8x1	M8x1	M8x1	M8x1
length (thread/complete)	36mm/42mm	42mm/54mm	33mm/42mm	39mm/54mm
housing material	stainl. steel	stainl. steel	stainl. steel	stainl. steel
material (front cap)	PTFE	PTFE	PTFE	PTFE
operating temperature	-10 ... +70°C	-10 ... +70°C	-10 ... +70°C	-10 ... +70°C
degree of protection (EN 60529)	IP65	IP65	IP65	IP65
connection	2m PUR cable, 3-wire	M8-connector, 3-pin	2m PUR cable, 3-wire	M8-connector, 3-pin
connection accessories	-	e.g. VK200075	-	e.g. VK200075
mounting accessories (clip)	AY000047	AY000047	AY000047	AY000047
mounting accessories (universal holder)	AY000115	AY000115	AY000115	AY000115

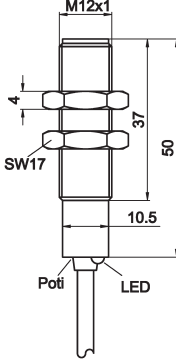
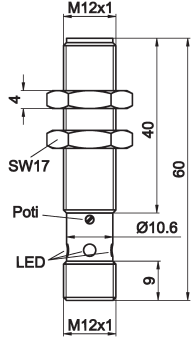
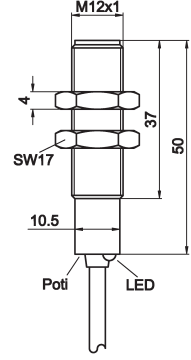
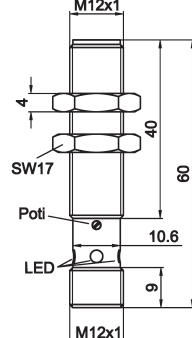
article-no.	KB120100	KB120120	KB120400	KB120420
switching distance	0 ... 6mm	0 ... 6mm	0 ... 6mm	0 ... 6mm
output signal	npn, no	npn, no	npn, no/nc	npn, no/nc
mounting	flush	flush	flush	flush
connection	cable	M12-connector	cable	M12-connector
				
TECHNICAL DATA				
switching distance	0 ... 6mm	0 ... 6mm	0 ... 6mm	0 ... 6mm
output signal	npn, no	npn, no	npn, no/nc	npn, no/nc
operating voltage	10 ... 35V DC	10 ... 35V DC	10 ... 35V DC	10 ... 35V DC
current consumption (w/o load)	≤ 15mA	≤ 15mA	≤ 15mA	≤ 15mA
output current (max. load)	250mA	250mA	2x250mA	2x250mA
voltage drop (max. load)	2.0V DC	2.0V DC	2.0V DC	2.0V DC
hysteresis	5 ... 15%	5 ... 15%	5 ... 15%	5 ... 15%
switching frequency	500Hz	500Hz	500Hz	500Hz
correction factors	wood, glass approx. 0.6 oil, PVC approx. 0.5	wood, glass approx. 0.6 oil, PVC approx. 0.5	wood, glass approx. 0.6 oil, PVC approx. 0.5	wood, glass approx. 0.6 oil, PVC approx. 0.5
display (signal)	yellow LED	yellow LED	yellow LED	yellow LED
display (operation)	green LED	-	green LED	-
short-circuit protection	+	+	+	+
reverse polarity protection	+	+	+	+
sensitivity adjustment	potentiometer	potentiometer	potentiometer	potentiometer
dimensions	M12x1	M12x1	M12x1	M12x1
length (thread/complete)	37mm/50mm	40mm/60mm	37mm/50mm	40mm/60mm
housing material	stainl. steel	stainl. steel	stainl. steel	stainl. steel
material (front cap)	PTFE	PTFE	PTFE	PTFE
operating temperature	-25 ... +70°C	-25 ... +70°C	-25 ... +70°C	-25 ... +70°C
degree of protection (EN 60529)	IP67	IP67	IP67	IP67
connection	2m PUR cable, 3-wire	M12-connector, 3-pin	2m PUR cable, 4-wire	M12-connector, 4-pin
connection accessories	-	e.g. VK200025	-	e.g. VK200325
mounting accessories (clip)	AY000049	AY000049	AY000049	AY000049
mounting accessories (universal holder)	AY000115	AY000115	AY000115	AY000115

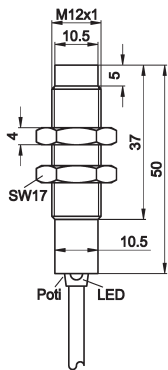
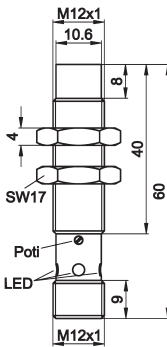
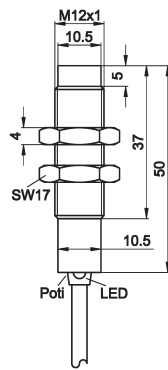
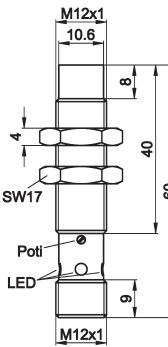
article-no.	KN120100	KN120120	KN120400	KN120420
switching distance	0.5 ... 10mm	0.5 ... 10mm	0.5 ... 10mm	0.5 ... 10mm
output signal	pnp, no	pnp, no	pnp, no/nc	pnp, no/nc
mounting	non-flush	non-flush	non-flush	non-flush
connection	cable	M12-connector	cable	M12-connector
				
TECHNICAL DATA				
switching distance	0.5 ... 10mm	0.5 ... 10mm	0.5 ... 10mm	0.5 ... 10mm
output signal	pnp, no	pnp, no	pnp, no/nc	pnp, no/nc
operating voltage	10 ... 35V DC	10 ... 35V DC	10 ... 35V DC	10 ... 35V DC
current consumption (w/o load)	≤ 15mA	≤ 15mA	≤ 15mA	≤ 15mA
output current (max. load)	250mA	250mA	2x250mA	2x250mA
voltage drop (max. load)	2.0V DC	2.0V DC	2.0V DC	2.0V DC
hysteresis	5 ... 15%	5 ... 15%	5 ... 15%	5 ... 15%
switching frequency	50Hz	50Hz	50Hz	50Hz
correction factors	wood, glass approx. 0.6 oil, PVC approx. 0.5	wood, glass approx. 0.6 oil, PVC approx. 0.5	wood, glass approx. 0.6 oil, PVC approx. 0.5	wood, glass approx. 0.6 oil, PVC approx. 0.5
display (signal)	yellow LED	yellow LED	yellow LED	yellow LED
display (operation)	green LED	-	green LED	-
short-circuit protection	+	+	+	+
reverse polarity protection	+	+	+	+
sensitivity adjustment	potentiometer	potentiometer	potentiometer	potentiometer
dimensions	M12x1	M12x1	M12x1	M12x1
length (thread/complete)	30mm/50mm	32mm/60mm	30mm/50mm	32mm/60mm
housing material	stainl. steel	stainl. steel	stainl. steel	stainl. steel
material (front cap)	PTFE	PTFE	PTFE	PTFE
operating temperature	-25 ... +70°C	-25 ... +70°C	-25 ... +70°C	-25 ... +70°C
degree of protection (EN 60529)	IP67	IP67	IP67	IP67
connection	2m PUR cable, 3-wire	M12-connector, 3-pin	2m PUR cable, 4-wire	M12-connector, 4-pin
connection accessories	-	e.g. VK200025	-	e.g. VK200325
mounting accessories (clip)	AY000049	AY000049	AY000049	AY000049
mounting accessories (universal holder)	AY000115	AY000115	AY000115	AY000115

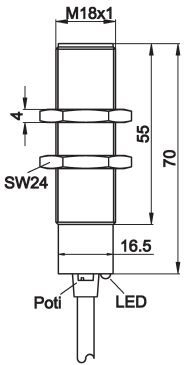
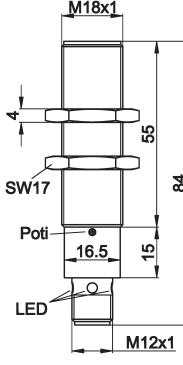
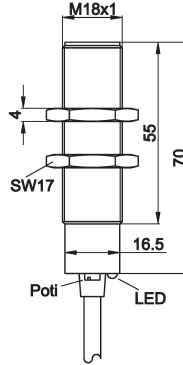
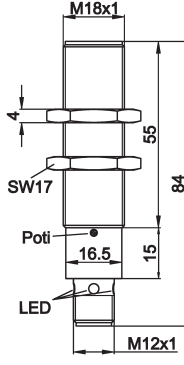
article-no.	KB180100	KB180120	KB180400	KB180420
switching distance	0.5 ... 10mm	0.5 ... 10mm	0.5 ... 10mm	0.5 ... 10mm
output signal	pnp, no	pnp, no	pnp, no/nc	pnp, no/nc
mounting	flush	flush	flush	flush
connection	cable	M12-connector	cable	M12-connector
				
TECHNICAL DATA				
switching distance	0.5 ... 10mm	0.5 ... 10mm	0.5 ... 10mm	0.5 ... 10mm
output signal	pnp, no	pnp, no	pnp, no/nc	pnp, no/nc
operating voltage	10 ... 35V DC	10 ... 35V DC	10 ... 35V DC	10 ... 35V DC
current consumption (w/o load)	≤ 15mA	≤ 15mA	≤ 15mA	≤ 15mA
output current (max. load)	250mA	250mA	2x250mA	2x250mA
voltage drop (max. load)	2.0V DC	2.0V DC	2.0V DC	2.0V DC
hysteresis	5 ... 15%	5 ... 15%	5 ... 15%	5 ... 15%
switching frequency	300Hz	300Hz	300Hz	300Hz
correction factors	wood, glass approx. 0.6 oil, PVC approx. 0.5	wood, glass approx. 0.6 oil, PVC approx. 0.5	wood, glass approx. 0.6 oil, PVC approx. 0.5	wood, glass approx. 0.6 oil, PVC approx. 0.5
display (signal)	yellow LED	yellow LED	yellow LED	yellow LED
display (operation)	green LED	-	green LED	-
short-circuit protection	+	+	+	+
reverse polarity protection	+	+	+	+
sensitivity adjustment	potentiometer	potentiometer	potentiometer	potentiometer
dimensions	M18x1	M18x1	M18x1	M18x1
length (thread/complete)	55mm/70mm	55mm/84mm	55mm/70mm	55mm/84mm
housing material	nickel-plated brass	nickel-plated brass	nickel-plated brass	nickel-plated brass
material (front cap)	PTFE	PTFE	PTFE	PTFE
operating temperature	-25 ... +70°C	-25 ... +70°C	-25 ... +70°C	-25 ... +70°C
degree of protection (EN 60529)	IP67	IP67	IP67	IP67
connection	2m PUR cable, 3-wire	M12-connector, 3-pin	2m PVC-cable, 4-wire	M12-connector, 4-pin
connection accessories	-	e.g. VK200025	-	e.g. VK200325
mounting accessories (clip)	AY000051	AY000051	AY000051	AY000051
mounting accessories (universal holder)	AY000117	AY000117	AY000117	AY000117

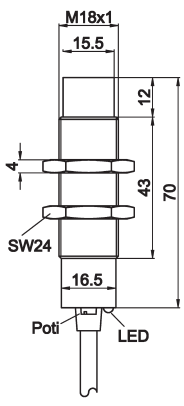
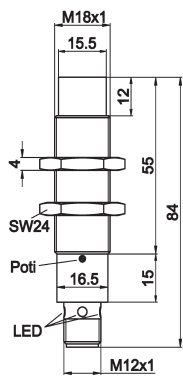
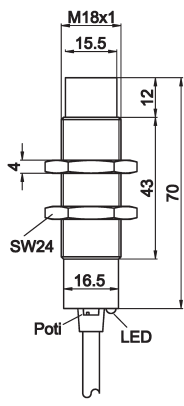
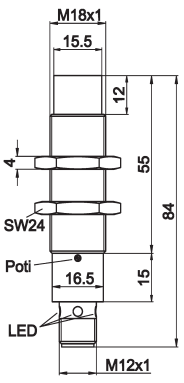
article-no.	KN180100	KN180120	KN180400	KN180420
switching distance	0.5 ... 15mm	0.5 ... 15mm	0.5 ... 15mm	0.5 ... 15mm
output signal	pnp, no	pnp, no	pnp, no/nc	pnp, no/nc
mounting	non-flush	non-flush	non-flush	non-flush
connection	cable	M12-connector	cable	M12-connector
				
TECHNICAL DATA				
switching distance	0.5 ... 15mm	0.5 ... 15mm	0.5 ... 15mm	0.5 ... 15mm
output signal	pnp, no	pnp, no	pnp, no/nc	pnp, no/nc
operating voltage	10 ... 35V DC	10 ... 35V DC	10 ... 35V DC	10 ... 35V DC
current consumption (w/o load)	≤ 15mA	≤ 15mA	≤ 15mA	≤ 15mA
output current (max. load)	250mA	250mA	2x250mA	2x250mA
voltage drop (max. load)	2.0V DC	2.0V DC	2.0V DC	2.0V DC
hysteresis	5 ... 15%	5 ... 15%	5 ... 15%	5 ... 15%
switching frequency	50Hz	50Hz	50Hz	50Hz
correction factors	wood, glass approx. 0.6 oil, PVC approx. 0.5	wood, glass approx. 0.6 oil, PVC approx. 0.5	wood, glass approx. 0.6 oil, PVC approx. 0.5	wood, glass approx. 0.6 oil, PVC approx. 0.5
display (signal)	yellow LED	yellow LED	yellow LED	yellow LED
display (operation)	green LED	-	green LED	-
short-circuit protection	+	+	+	+
reverse polarity protection	+	+	+	+
sensitivity adjustment	potentiometer	potentiometer	potentiometer	potentiometer
dimensions	M18x1	M18x1	M18x1	M18x1
length (thread/complete)	43mm/70mm	43mm/84mm	43mm/70mm	43mm/84mm
housing material	nickel-plated brass	nickel-plated brass	nickel-plated brass	nickel-plated brass
material (front cap)	PTFE	PTFE	PTFE	PTFE
operating temperature	-25 ... +70°C	-25 ... +70°C	-25 ... +70°C	-25 ... +70°C
degree of protection (EN 60529)	IP67	IP67	IP67	IP67
connection	2m PUR cable, 3-wire	M12-connector, 3-pin	2m PVC-cable, 4-wire	M8-connector, 4-pin
connection accessories	-	e.g. VK200025	-	e.g. VK200325
mounting accessories (clip)	AY000051	AY000051	AY000051	AY000051
mounting accessories (universal holder)	AY000117	AY000117	AY000117	AY000117

article-no.	KN180107	KN184107	KN200107	KN200177
switching distance	1.0 ... 8.0mm	1.0 ... 8.0mm	3.5 ... 15mm	3.5 ... 15mm
output signal	pnp, no	AC, no	pnp, no	pnp, no
mounting	non-flush	non-flush	non-flush	non-flush
connection	cable	cable	cable	M8-connector
TECHNICAL DATA				
switching distance	1.0 ... 8.0mm	1.0 ... 8.0mm	3.5 ... 15mm	3.5 ... 15mm
output signal	pnp, no	AC, no	pnp, no	pnp, no
operating voltage	10 ... 60V DC	20 ... 250V AC	10 ... 60V DC	10 ... 60V DC
current consumption (w/o load)	≤ 15mA	≤ 20mA	≤ 15mA	≤ 15mA
minimum load current	-	-	5mA	-
output current (max. load)	200mA	300mA	400mA	400mA
voltage drop (max. load)	3.0V DC	10.0V AC	3.0V DC	3.0V DC
hysteresis	5 ... 15%	5 ... 15%	5 ... 15%	5 ... 15%
switching frequency	25Hz	15Hz	25Hz	25Hz
correction factors	wood, glass approx. 0.6 oil, PVC approx. 0.5	wood, glass approx. 0.6 oil, PVC approx. 0.5	wood, glass approx. 0.6 oil, PVC approx. 0.5	wood, glass approx. 0.6 oil, PVC approx. 0.5
display (signal)	yellow LED	yellow LED	yellow LED	yellow LED
display (operation)	green LED	green LED	green LED	green LED
short-circuit protection	+	-	+	+
reverse polarity protection	+	+	+	+
sensitivity adjustment	potentiometer	potentiometer	potentiometer	potentiometer
dimensions	M18x1	M18x1	Ø 20mm	Ø 20mm
length (thread/complete)	40mm / 81mm	40mm / 81mm	- / 81mm	- / 81mm
housing material	PBT	PBT	PBT	PBT
material (front cap)	PA 6.6	PA 6.6	PA 6.6	PA 6.6
operating temperature	-25 ... +70°C	-25 ... +70°C	-25 ... +70°C	-25 ... +70°C
degree of protection (EN 60529)	IP67	IP67	IP67	IP67 *
connection	2m PVC-cable, 3-wire	2m PVC-cable, 2-wire	2m PVC-cable, 3-wire	M8-connector, 4-pin
connection accessories	-	-	-	e.g. VK200375
mounting accessories (clip)	AY000051	AY000051	-	-
mounting accessories (universal holder)	AY000117	AY000117	-	-



article-no.	KB300100	KB300120	KB300400	KB300420
switching distance	0.5 ... 25mm	0.5 ... 25mm	0.5 ... 25mm	0.5 ... 25mm
output signal	pnp, no	pnp, no	pnp, no/nc	pnp, no/nc
mounting	flush	flush	flush	flush
connection	cable	M12-connector	cable	M12-connector

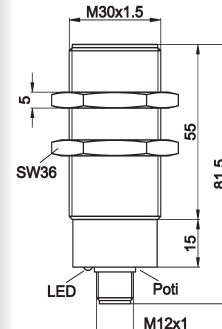
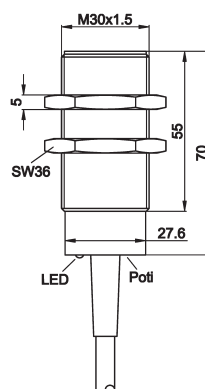
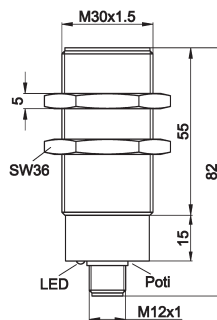
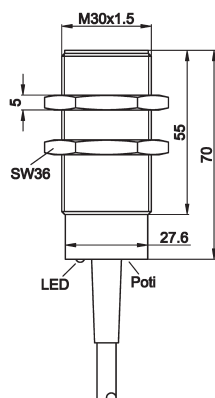

TECHNICAL DATA

switching distance	0.5 ... 25mm	0.5 ... 25mm	0.5 ... 25mm	0.5 ... 25mm
output signal	pnp, no	pnp, no	pnp, no/nc	pnp, no/nc
operating voltage	10 ... 35V DC	10 ... 35V DC	10 ... 35V DC	10 ... 35V DC
current consumption (w/o load)	≤ 15mA	≤ 15mA	≤ 15mA	≤ 15mA
output current (max. load)	250mA	250mA	2x250mA	2x250mA
voltage drop (max. load)	2.0V DC	2.0V DC	2.0V DC	2.0V DC
hysteresis	5 ... 15%	5 ... 15%	5 ... 15%	5 ... 15%
switching frequency	200Hz	200Hz	200Hz	200Hz
correction factors	wood, glass approx. 0.6 oil, PVC approx. 0.5	wood, glass approx. 0.6 oil, PVC approx. 0.5	wood, glass approx. 0.6 oil, PVC approx. 0.5	wood, glass approx. 0.6 oil, PVC approx. 0.5
display (signal)	yellow LED	yellow LED	yellow LED	yellow LED
display (operation)	green LED	green LED	green LED	green LED
short-circuit protection	+	+	+	+
reverse polarity protection	+	+	+	+
sensitivity adjustment	potentiometer	potentiometer	potentiometer	potentiometer
dimensions	M30x1.5	M30x1.5	M30x1.5	M30x1.5
length (thread/complete)	55mm/70mm	55mm/82mm	55mm/70mm	55mm/82mm
housing material	nickel-plated brass	nickel-plated brass	nickel-plated brass	nickel-plated brass
material (front cap)	PTFE	PTFE	PTFE	PTFE
operating temperature	-25 ... +70°C	-25 ... +70°C	-25 ... +70°C	-25 ... +70°C
degree of protection (EN 60529)	IP67	IP67	IP67	IP67
connection	2m PVC-cable, 3-wire	M12-connector, 3-pin	2m PVC-cable, 4-wire	M12-connector, 4-pin
connection accessories	-	e.g. VK200025	-	e.g. VK200325
mounting accessories (clip)	AY000061	AY000061	AY000061	AY000061

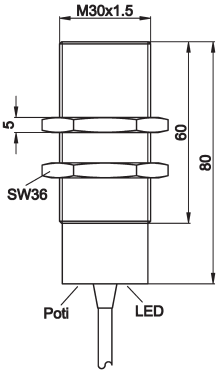
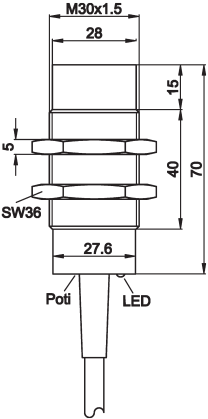
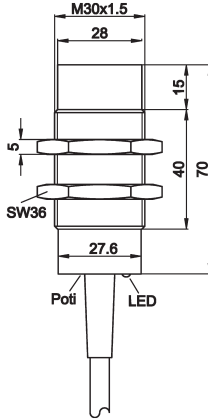
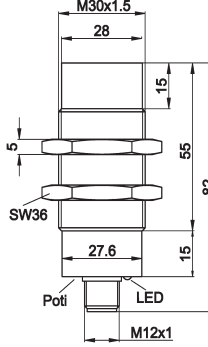
article-no.	KB304100	KN300100	KN300400	KN300420
switching distance	3.0 ... 15mm	1.0 ... 30mm	1.0 ... 30mm	1.0 ... 30mm
output signal	AC, no	pnp, no	pnp, no/nc	pnp, no/nc
mounting	flush	non-flush	non-flush	non-flush
connection	cable	cable	cable	M12-connector
				
TECHNICAL DATA				
switching distance	3.0 ... 15mm	1.0 ... 30mm	1.0 ... 30mm	1.0 ... 30mm
output signal	pnnp, no	pnnp, no	pnnp, no/nc	pnnp, no/nc
operating voltage	20 ... 250V AC	10 ... 35V DC	10 ... 35V DC	10 ... 35V DC
current consumption (w/o load)	≤ 15mA	≤ 15mA	≤ 15mA	≤ 15mA
minimum load current	5mA	-	-	-
output current (max. load)	400mA	400mA	2x250mA	2x250mA
voltage drop (max. load)	2.0V DC	2.0V DC	2.0V DC	2.0V DC
hysteresis	5 ... 15%	5 ... 15%	5 ... 15%	5 ... 15%
switching frequency	15Hz	50Hz	50Hz	50Hz
correction factors	wood, glass approx. 0.6 oil, PVC approx. 0.5	wood, glass approx. 0.6 oil, PVC approx. 0.5	wood, glass approx. 0.6 oil, PVC approx. 0.5	wood, glass approx. 0.6 oil, PVC approx. 0.5
display (signal)	yellow LED	yellow LED	yellow LED	yellow LED
display (operation)	-	green LED	green LED	green LED
short-circuit protection	3A/10ms	+	+	+
reverse polarity protection	+	+	+	+
sensitivity adjustment	potentiometer	potentiometer	potentiometer	potentiometer
dimensions	M30x1.5	M30x1.5	M30x1.5	M30x1.5
length (thread/complete)	60mm/80mm	40mm/70mm	40mm/70mm	40mm/82mm
housing material	nickel-plated brass	nickel-plated brass	nickel-plated brass	nickel-plated brass
material (front cap)	PPO	PTFE	PTFE	PTFE
operating temperature	-25 ... +70°C	-25 ... +70°C	-25 ... +70°C	-25 ... +70°C
degree of protection (EN 60529)	IP67	IP67	IP67	IP67
connection	2m PVC-cable, 3-wire	2m PVC-cable, 3-wire	2m PVC-cable, 4-wire	M12-connector, 4-pin
connection accessories	-	-	-	e.g. VK200325
mounting accessories (clip)	AY000061	AY000061	AY000061	AY000061

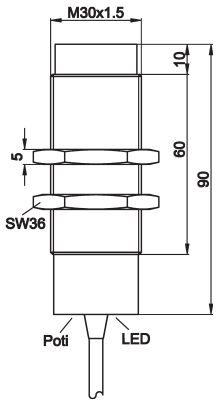
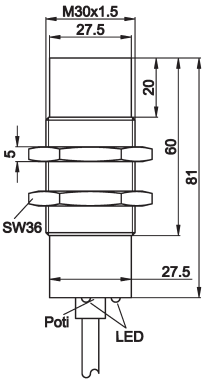
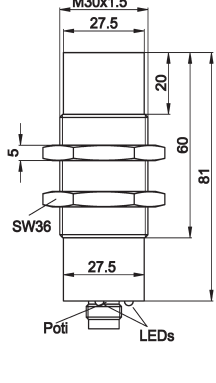
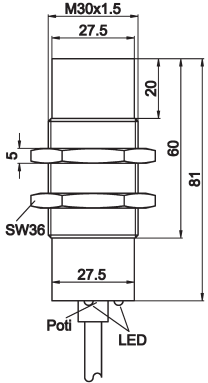

article-no.	KN304100	KN300107	KN300127	KN304107
switching distance	3.0 ... 20mm	5.0 ... 20mm	5.0 ... 20mm	5.0 ... 20mm
output signal	AC, no	npn, no	npn, no	AC, no
mounting	non-flush	non-flush	non-flush	non-flush
connection	cable	cable	M12-connector	cable
				
TECHNICAL DATA				
switching distance	3.0 ... 20mm	5.0 ... 20mm	5.0 ... 20mm	5.0 ... 20mm
output signal	npn, no	npn, no	npn, no/nc	AC, no
operating voltage	20 ... 250V AC	10 ... 60V DC	10 ... 60V DC	20 ... 250V AC
current consumption (w/o load)	≤ 2.5A	≤ 20mA	≤ 20mA	≤ 15mA
minimum load current	5mA	-	-	5mA
output current (max. load)	400mA	400mA	400mA	300mA
voltage drop (max. load)	10.0V AC	3.0V DC	3.0V DC	10.0V AC
hysteresis	5 ... 15%	5 ... 15%	5 ... 15%	5 ... 15%
switching frequency	25Hz	25Hz	25Hz	15Hz
correction factors	wood, glass approx. 0.6 oil, PVC approx. 0.5	wood, glass approx. 0.6 oil, PVC approx. 0.5	wood, glass approx. 0.6 oil, PVC approx. 0.5	wood, glass approx. 0.6 oil, PVC approx. 0.5
display (signal)	yellow LED	yellow LED	yellow LED	yellow LED
display (operation)	green LED	green LED	green LED	green LED
short-circuit protection	3A/10ms	+	+	-
reverse polarity protection	+	+	+	+
sensitivity adjustment	potentiometer	potentiometer	potentiometer	potentiometer
dimensions	M30x1.5	M30x1.5	M30x1.5	M30x1.5
length (thread/complete)	60mm/90mm	40mm/81mm	40mm/81mm	40mm/81mm
housing material	nickel-plated brass	PBT	PBT	PBT
material (front cap)	PPO	PA 6.6	PA 6.6	PA 6.6
operating temperature	-25 ... +70°C	-25 ... +70°C	-25 ... +70°C	-25 ... +70°C
degree of protection (EN 60529)	IP67	IP67	IP67 *	IP67
connection	2m PVC-cable, 3-wire	2m PVC-cable, 3-wire	M12-connector, 3-pin	2m PVC-cable, 2-wire
connection accessories	-	-	e.g. VK200025	-
mounting accessories (clip)	AY000061	AY000061	AY000061	AY000061

* only with screwed-on cable socket

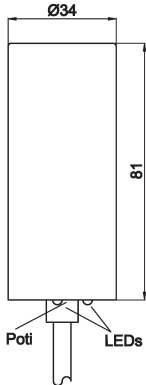
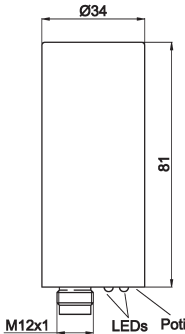
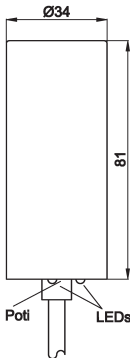
article-no.	KN340107	KN340127	KN344107
switching distance	6.0 ... 30mm	6.0 ... 30mm	6.0 ... 30mm
output signal	pnp, no	pnp, no	AC, no
mounting	non-flush	non-flush	non-flush
connection	cable	M12-connector	cable
			
TECHNICAL DATA			
switching distance	6.0 ... 30mm	6.0 ... 30mm	6.0 ... 30mm
output signal	pnp, no	pnp, no	AC, no
operating voltage	10 ... 60V DC	10 ... 60V DC	20 ... 250V AC
current consumption (w/o load)	≤ 20mA	≤ 20mA	≤ 15mA
minimum load current	-	-	5mA
output current (max. load)	400mA	400mA	30mA
voltage drop (max. load)	3.0V DC	3.0V DC	10.0V AC
hysteresis	5 ... 15%	5 ... 15%	5 ... 15%
switching frequency	25Hz	25Hz	15Hz
correction factors	wood, glass approx. 0.6 oil, PVC approx. 0.5	wood, glass approx. 0.6 oil, PVC approx. 0.5	wood, glass approx. 0.6 oil, PVC approx. 0.5
display (signal)	yellow LED	yellow LED	yellow LED
display (operation)	green LED	green LED	green LED
short-circuit protection	+	+	-
reverse polarity protection	+	+	+
sensitivity adjustment	potentiometer	potentiometer	potentiometer
dimensions	Ø 34mm	Ø 34mm	Ø 34mm
length (thread/complete)	- / 81mm	- / 81mm	- / 81mm
housing material	PBT	PBT	PBT
material (front cap)	PA 6.6	PA 6.6	PA 6.6
operating temperature	-25 ... +70°C	-25 ... +70°C	-25 ... +70°C
degree of protection (EN 60529)	IP67	IP67 *	IP67
connection	2m PVC-cable, 3-wire	M12-connector, 3-pin	2m PVC-cable, 2-wire
connection accessories	-	e.g. VK200025	-
mounting accessories (clip)	-	-	-



article-no.	KN800100	KN804100	KN830100	KN834100
switching distance	1.0 ... 70mm	1.0 ... 70mm	1.0 ... 120mm	1.0 ... 120mm
output signal	pnp, no	AC, no	pnp, no	AC, no
mounting	non-flush	non-flush	non-flush	non-flush
connection	cable	cable	cable	cable
TECHNICAL DATA				
switching distance	1.0 ... 70mm	1.0 ... 70mm	1.0 ... 120mm	1.0 ... 120mm
output signal	pnp, no	AC, no	pnp, no	AC, no
operating voltage	10 ... 55V DC	20 ... 250V AC	10 ... 55V DC	20 ... 250V DC
current consumption (w/o load)	≤ 4.0mA	≤ 2.5mA	≤ 4.0mA	≤ 2.5mA
minimum load current	-	5mA	-	5mA
output current (max. load)	400mA	400mA	400mA	400mA
voltage drop (max. load)	1.5V DC	10.0V AC	1.5V DC	10.0V AC
hysteresis	5 ... 15%	5 ... 15%	5 ... 15%	5 ... 15%
switching frequency	10Hz	10Hz	10Hz	10Hz
correction factors	wood, glass approx. 0.6 oil, PVC approx. 0.5	wood, glass approx. 0.6 oil, PVC approx. 0.5	wood, glass approx. 0.6 oil, PVC approx. 0.5	wood, glass approx. 0.6 oil, PVC approx. 0.5
display (signal)	yellow LED	yellow LED	yellow LED	yellow LED
short-circuit protection	+	3A/10ms	+	3A/10ms
reverse polarity protection	+	+	+	+
dimensions	∅ 80mm	∅ 80mm	∅ 100mm	∅ 100mm
length (thread/complete)	-/40mm	-/40mm	-/40mm	-/40mm
housing material	PBT	PBT	PBT	PBT
material (front cap)	PBT	PBT	PBT	PBT
operating temperature	-25 ... +70°C	-25 ... +70°C	-25 ... +70°C	-25 ... +70°C
degree of protection (EN 60529)	IP67	IP67	IP67	IP67
connection	2m PVC-cable, 3-wire	2m PVC-cable, 2-wire	2m PVC-cable, 3-wire	2m PVC-cable, 2-wire
connection accessories	-	-	-	-
mounting accessories (clip)	-	-	-	-

connection

PNP, no

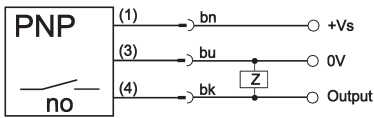

PNP, no/nc

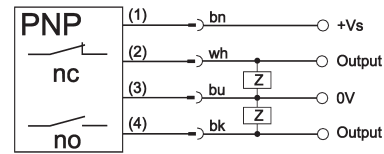

AC, no

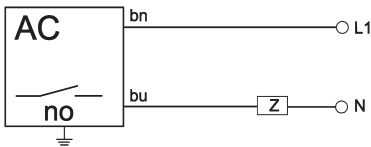

wire colors: bn = brown (1), white = (wh), bu = blue (3), bk = black (4)

universal mounting **AY000115 / AY000117**
consisting of **base module**

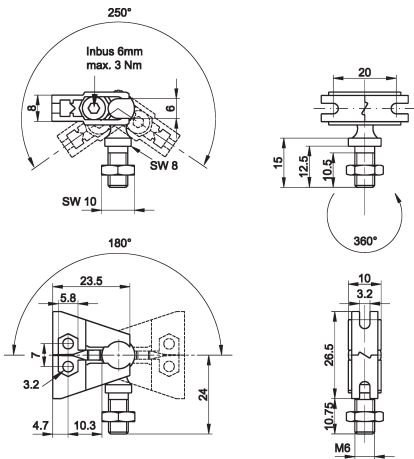

... and fitting panel

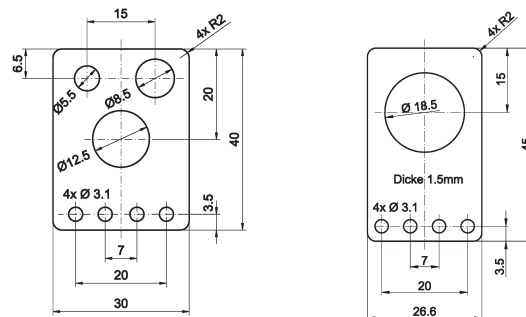

ACCESSORIES

article-no.	description	diameter	material
AY000088	base module*		flanges: stainless steel, ball pins: galvanized steel
AY000115	mounting kit for M5, M8, M12 sensors		stainless steel
AY000117	mounting kit for M18 sensors		stainless steel
AY000047	quick clip	8mm	PA6 / galvanized steel
AY000048	quick clip with positive stop	8mm	PA6 / galvanized steel
AY000049	quick clip	12mm	PA6 / galvanized steel
AY000050	quick clip with positive stop	12mm	PA6 / galvanized steel
AY000051	quick clip	18mm	PA6 / galvanized steel
AY000052	quick clip with positive stop	18mm	PA6 / galvanized steel
AY000061	quick clip	30mm	PA6 / galvanized steel
AY000062	quick clip with positive stop	30mm	PA6 / galvanized steel
AY000053	straight base for quick clip	12mm, 18mm	PA6 / galvanized steel
AY000054	angular base for quick clip	12mm, 18mm	PA6 / galvanized steel
AY000055	quick clip label	12 ... 30mm	plastic / -
AY000057	box set with selection of quick clips	4 ... 18mm	plastic / -

The **AY000088** base module is contained in every mounting kit

Material of bolts and nuts: galvanized steel

This data sheet only contains the available standard variants. For other output / connection variants, we kindly ask that you contact us.

We are happy to supply the right cable socket for the plug equipment. You will find a list in the "accessories" section of the catalog under **ipf-SENSORFLEX** "cable sockets" or in the search window on our homepage www.ipf-electronic.com (using the search term "VK").

Warning: Never use these devices in applications where the safety of a person depends on their functionality.

NOTES

A large grid area for taking notes, consisting of a 20x30 grid of small squares. The grid is empty and occupies the majority of the page.