

dimensions	M8x1 M12x1	
version	soldered connection	straight
	screw terminals	angular straight angular



- ✓ **M8 and M12 connectors**
- ✓ **rapid interconnection technology**
- ✓ **straight and angular version**
- ✓ **easy mounting**
- ✓ **plastic, nickel-plated brass**
- ✓ **LED display for operation and output signal**
- ✓ **fastening nut made of stainl. steel**

**field attachable
screw or soldered connection**



description

Today, field-attachable cable sockets and connectors have become indispensable in many parts of industrial production. There is a good reason for this: With these cable sockets and connectors, the user has the ability to establish as well as disconnect an electrical connection.

ipf cable sockets and connectors are available in M8 (3- and 4-pin) and M12 (4-, 5-, and 8-pin) designs. The connection cable can be attached to the plug connector either via a screw or solder connection. The plug connectors must not be plugged in and unplugged while under load, unlike the plug-in units.

The plug connectors with LED display signal the operating vol-

tage and the status of the switching output (pnp) or of both switching outputs (2x pnp).

As a result, standard sensor types with fixed cable length can be individually adapted in the field. Interfering loops of extra cable are thereby eliminated and time and money are saved. Multiple uses are possible and the high requirements of degree of protection **IP 67** are satisfied.

application examples

- ▶ field attachment of plug connectors with fixed-cable devices or connection lines

article-no.	VK003070	VK003074	VK003076	VK003078
version	M8 cable socket angular, 3-pin	M8 cable socket straight, 3-pin	M8 cable connector angular, 3-pin	M8 cable connector straight, 3-pin
connection	soldered connection BK10/∅ 3.5 ... 5.0mm	soldered connection BK10/∅ 3.5 ... 5.0mm	soldered connection BK10/∅ 3.5 ... 5.0mm	soldered connection BK10/∅ 3.5 ... 5.0mm
article-no.	VK003071	VK003075	-	VK003079
version	M8 cable socket angular, 4-pin	M8 cable socket straight, 4-pin	-	M8 cable connector straight, 4-pin
connection	soldered connection BK10/∅ 3.5 ... 5.0mm	soldered connection BK10/∅ 3.5 ... 5.0mm	-	soldered connection BK10/∅ 3.5 ... 5.0mm

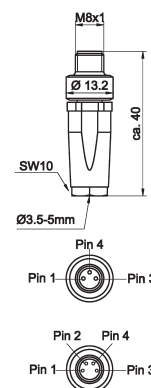
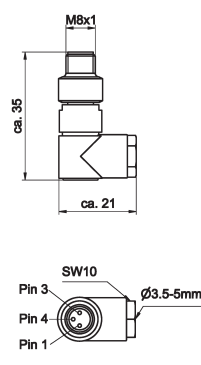
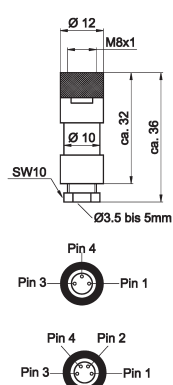
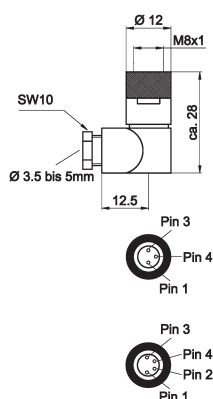

TECHNICAL DATA

voltage Un	60V DC, 3-pin 30V DC, 4-pin	60V DC, 3-pin 30V DC, 4-pin	60V DC, 3-pin 30V DC, 4-pin	60V DC, 3-pin 30V DC, 4-pin
current In	4A	4A	4A	4A
wire cross section	max. 0.25mm ²	max. 0.25mm ²	max. 0.25mm ²	max. 0.34mm ²
operating temperature	-40 ... +85°C	-40 ... +85°C	-40 ... +85°C	-25 ... +80°C
housing material	PBT / nickel-plated brass	PBT / nickel-plated brass	PBT / nickel-plated brass	CuZn, nickel-plated
material (contacts)	CuZn, gold-plated	CuZn, gold-plated	CuZn, gold-plated	CuZn, gold-plated
insulation resistance	≤ 10 ⁹ ohm	≤ 10 ⁹ ohm	≤ 10 ⁹ ohm	≤ 10 ⁹ ohm
degree of protection (EN 60529)	IP 67	IP 67	IP 67	IP 67
connection	soldered connection cable gland BK10/∅ 3.5 ... 5.0mm	soldered connection cable gland BK10/∅ 3.5 ... 5.0mm	soldered connection cable gland BK10/∅ 3.5 ... 5.0mm	soldered connection cable gland BK10/∅ 3.5 ... 5.0mm
degree of soiling	3	3	3	3

article-no.	VK003174	VK003178
version	M8 cable socket straight, 3-pin	M8 cable connector straight, 3-pin
connection	screw terminals BK10/∅ 3.5 ... 5.0mm	screw terminals BK10/∅ 3.5 ... 5.0mm
article-no.	VK003175	VK003179
version	M8 cable socket straight, 4-pin	M8 cable connector straight, 4-pin
connection	screw terminals BK10/∅ 3.5 ... 5.0mm	screw terminals BK10/∅ 3.5 ... 5.0mm
TECHNICAL DATA		
voltage Un	60V DC, 3-pin 30V DC, 4-pin	60V DC, 3-pin 30V DC, 4-pin
current In	4A	4A
wire cross section	0.14 ... 0.5mm ²	0.14 ... 0.5mm ²
operating temperature	-40 ... +85°C	-40 ... +85°C
housing material	PA / nickel-plated brass	PA / nickel-plated brass
material (contacts)	CuZn, gold-plated	CuZn, gold-plated
insulation resistance	> 10 ⁹ ohm	> 10 ⁹ ohm
degree of protection (EN 60529)	IP 67	IP 67
connection	screw terminals cable gland BK10/∅ 3.5 ... 5.0mm	screw terminals cable gland BK10/∅ 3.5 ... 5.0mm
degree of soiling	3	3

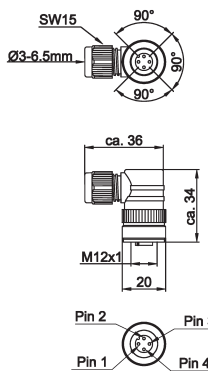
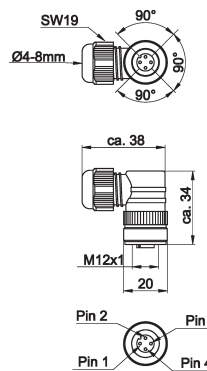
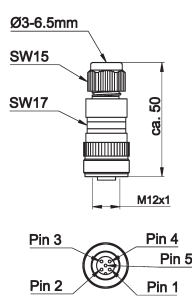
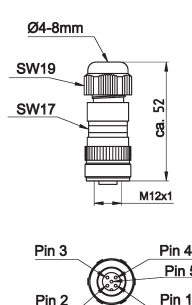
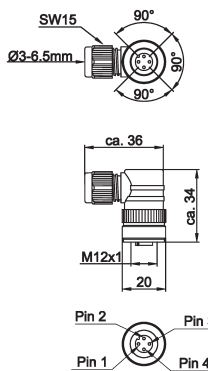
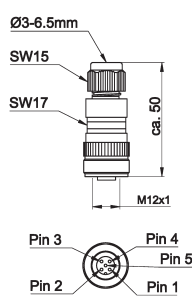
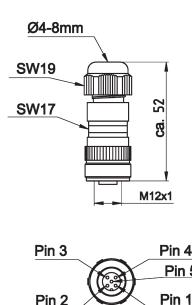
article-no.	VK003020	VK003C20	VK003024	VK003C24
version	M12 cable socket angular, 4-pin	M12 cable socket angular, 4-pin	M12 cable socket straight, 4-pin	M12 cable socket straight, 4-pin
connection	screw terminals BK15/∅ 3.5 ... 6.5mm	screw terminals BK19/∅ 4.0 ... 8.0mm	screw terminals BK15/∅ 3.5 ... 6.5mm	screw terminals BK19/∅ 4.0 ... 8.0mm
article-no.	VK003021	-	VK003025	VK003C25
version	M12 cable socket angular, 5-pin	M12 cable socket -	M12 cable socket straight, 5-pin	straight, 5-pin
connection	screw terminals BK15/∅ 3.5 ... 6.5mm	-	screw terminals BK15/∅ 3.5 ... 6.5mm	screw terminals BK19/∅ 4.0 ... 8.0mm
				
		-		
TECHNICAL DATA				
voltage Un	240V DC, 4-pin 60V DC, 5-pin	240V DC, 4-pin -	240V DC, 4-pin 60V DC, 5-pin	240V DC, 4-pin 60V DC, 5-pin
current In	4A	4A	4A	4A
wire cross section	max. 0.75mm ²	max. 0.75mm ²	max. 0.75mm ²	max. 0.75mm ²
operating temperature	-25 ... +90°C	-25 ... +90°C	-25 ... +90°C	-25 ... +90°C
housing material	PBT	PBT	PBT	PBT
material (contacts)	CuZn, gold-plated	CuZn, gold-plated	CuZn, gold-plated	CuZn, gold-plated
insulation resistance	> 10 ⁹ ohm	> 10 ⁹ ohm	> 10 ⁹ ohm	> 10 ⁹ ohm
degree of protection (EN 60529)	IP 67	IP 67	IP 67	IP 67
connection	screw terminals cable gland BK15/∅ 3.5 ... 6.5mm	screw terminals cable gland BK19/∅ 4.0 ... 8.0mm	screw terminals cable gland BK15/∅ 3.5 ... 6.5mm	screw terminals cable gland BK19/∅ 4.0 ... 8.0mm
degree of soiling	3	3	3	3

article-no.	VK003026	VK003028	VK003C28
version	M12 cable socket angular, 4-pin	M12 cable socket straight, 4-pin	M12 cable socket straight, 4-pin
connection	screw terminals BK15/Ø 3.5 ... 6.5mm	screw terminals BK15/Ø 3.5 ... 6.5mm	screw terminals BK19/Ø 4.0 ... 8.0mm
article-no.	VK003027	VK003029	VK003C29
version	M12 cable socket angular, 5-pin	M12 cable socket straight, 5-pin	M12 cable socket straight, 5-pin
connection	screw terminals BK15/Ø 3.5 ... 6.5mm	screw terminals BK15/Ø 3.5 ... 6.5mm	screw terminals BK19/Ø 4.0 ... 8.0mm
TECHNICAL DATA			
voltage Un	240V DC, 4-pin 60V DC, 5-pin	240V DC, 4-pin 60V DC, 5-pin	240V DC, 4-pin 60V DC, 5-pin
current In	4A	4A	4A
wire cross section	max. 0.75mm ²	max. 0.75mm ²	max. 0.75mm ²
operating temperature	-25 ... +90°C	-25 ... +90°C	-25 ... +90°C
housing material	PBT	PBT	PBT
material (contacts)	CuZn, gold-plated	CuZn, gold-plated	CuZn, gold-plated
insulation resistance	> 10 ⁹ ohm	> 10 ⁹ ohm	> 10 ⁹ ohm
degree of protection (EN 60529)	IP 67	IP 67	IP 67
connection	screw terminals cable gland BK15/Ø 3.5 ... 6.5mm	screw terminals cable gland BK15/Ø 3.5 ... 6.5mm	screw terminals cable gland BK19/Ø 4.0 ... 8.0mm
degree of soiling	3	3	3

article-no.	VK003820	VK003828	VK00382D	VK00382H
version	M12 cable socket angular, 4-pin	M12 cable connector straight, 4-pin	M12 cable socket straight, 8-pin	M12 cable connector straight, 8-pin
connection	screw terminals BK15/∅ 3.0 ... 6.5mm	screw terminals BK15/∅ 3.0 ... 6.5mm	screw terminals BK19/∅ 4.0 ... 8.0mm	screw terminals BK19/∅ 4.0 ...
8.0mm				
TECHNICAL DATA				
voltage Un	240V DC	240V DC	30V DC	30V DC
current In	4A	4A	2A	2A
wire cross section	max. 0.75mm ²	max. 0.75mm ²	max. 0.5mm ²	max. 0.5mm ²
operating temperature	-25 ... +90°C	-25 ... +90°C	-25 ... +85°C	-25 ... +85°C
housing material	PBT / stainl. steel	PBT / stainl. steel	PBT / stainl. steel	PBT / stainl. steel
material (contacts)	CuZn	CuZn	CuZn	CuZn
insulation resistance	> 10 ⁹ ohm	> 10 ⁹ ohm	> 10 ⁹ ohm	> 10 ⁹ ohm
degree of protection (EN 60529)	IP 67	IP 67	IP 67	IP 67
connection	screw terminals cable gland BK15/∅ 3.5 ... 6.5mm	screw terminals cable gland BK15/∅ 3.5 ... 6.5mm	screw terminals cable gland BK15/∅ 3.5 ... 6.5mm	screw terminals cable gland BK15/∅ 3.5 ... 6.5mm
degree of soiling	3	3	3	3

article-no.	VK003220	VK003224	VK003E24	VK003E28
version	M12 cable socket angular, 4-pin	M12 cable socket straight, 4-pin	M12 cable socket straight, 4-pin	M12 cable connector straight, 4-pin
display	3x LED	3x LED	-	-
connection	screw terminals BK15/Ø 3.0 ... 6.5mm	screw terminals BK15/Ø 3.0 ... 6.5mm	screw terminals BK19 / 2x Ø3mm/ 2x Ø5mm	screw terminals BK19 / 2x Ø3mm/ 2x Ø5mm
TECHNICAL DATA				
voltage Un	10 ... 30V DC	10 ... 30V DC	240V DC	240V DC
current In	4A	4A	4A	4A
wire cross section	max. 0.75mm ²	max. 0.75mm ²	max. 0.75mm ²	max. 0.75mm ²
operating temperature	-25 ... +90°C	-25 ... +90°C	-25 ... +90°C	-25 ... +90°C
housing material	PBT / nickel-plated brass	PBT / nickel-plated brass	PBT / nickel-plated brass	PBT / nickel-plated brass
material (contacts)	CuZn	CuZn	CuZn	CuZn
insulation resistance	> 10 ⁹ ohm	> 10 ⁹ ohm	> 10 ⁹ ohm	> 10 ⁹ ohm
display (operation)	green LED	green LED	-	-
display (signal)	2x yellow LED	2x yellow LED	-	-
degree of protection (EN 60529)	IP 67	IP 67	IP 67	IP 67
connection	screw terminals cable gland BK15/Ø 3.0 ... 6.5mm	screw terminals cable gland BK15/Ø 3.0 ... 6.5mm	screw terminals, 2 cables cable gland BK19/2x Ø3mm/ 2x Ø5mm	screw terminals, 2 cables cable gland BK19/2x Ø3mm/ 2x Ø5mm
degree of soiling	3	3	3	3

connection

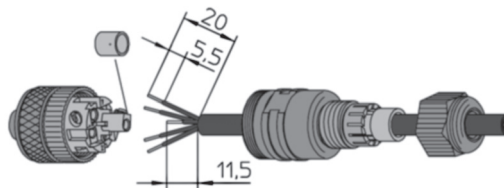
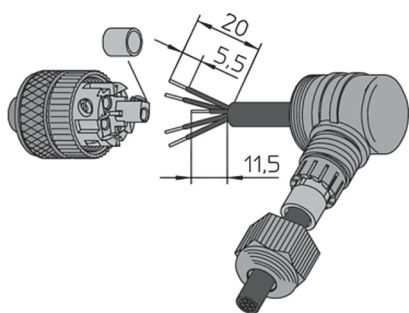

ACCESSORIES

ARTICLE-NO.	DESCRIPTION	COMMENT
AV000018	cable 4 x 0.34mm ² , PUR	highly flexible
AV000105	cable 3 x 0.34mm ² , PUR	highly flexible
AV000118	cable 4 x 0.34mm ² , PUR	highly flexible, shielded
AV000120	cable 5 x 0.34mm ² , PUR	highly flexible, shielded

Warning: Never use these devices in applications where the safety of a person depends on their functionality.

This data sheet as well as your personal contact can be found at www.ipf-electronic.com