

sensor diameter

- 4.0mm
- 5.0mm
- 6.5mm
- 8.0mm
- 12.0mm
- 18.0mm
- 30.0mm

- ✓ quick clips with permanent stop eliminate adjustment when exchanging sensors
- ✓ short start up and machine downtimes
- ✓ mounting sensors with one screw
- ✓ easy alignment thanks to oblong holes
- ✓ one-piece and universal usable
- ✓ combinable with 2 different bases for different alignments
- ✓ easy clip-on labels



mount round devices in no time at all

description

The *ipf electronic* quick clips support you when it comes to the time consuming adjustment of sensors. Round or threaded sensors of various diameters can be mounted with these clips in a comfortable way.

The compact, one-piece, quick clip is adjusted and mounted once only via the both oblong holes (starting with Ø12mm). The sensor can be changed without altering the position of the quick clip. Therefore only the locking screw must be loosed a little bit and tightened after the sensor exchange.

The quick clip with permanent stop saves the need for any time consuming adjustment when changing sensors completely. Release the locking screw, remove the sensor, insert the new sensor till it touches the permanent stop, screw down the locking screw – that’s it!

Quick clips are not only used where machine downtime and

commissioning needs to be cut to a minimum. *ipf*-quick clips are also used in applications where sensors must be changed by untrained personnel.

Straight and angular versions of the quick clip base complete the possible field of application for various adjustments of sensors with 12 and 18mm diameter.

Sensor identification labels for labeling the equipment are also available from 12 to 30mm diameter.

The box set containing a wide variety of different quick clips and bases offers the professional practical support when it comes to mounting sensors.

application examples

- ▶ mounting of round devices

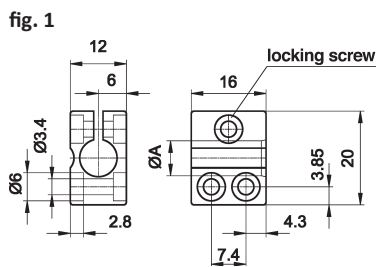

measure A corresponds to the sensor diameter

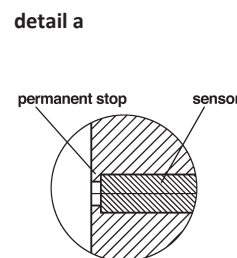
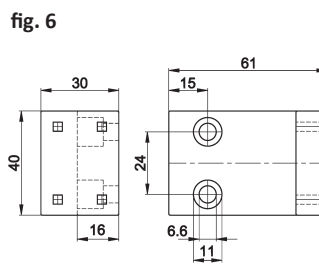
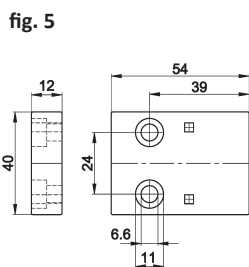
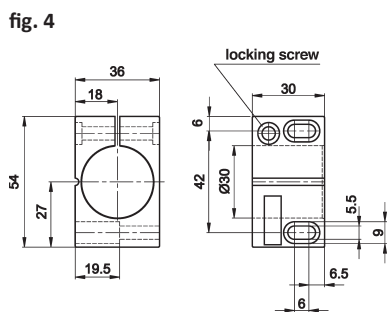
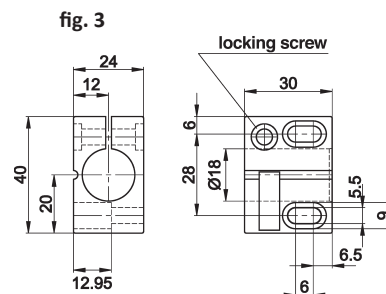
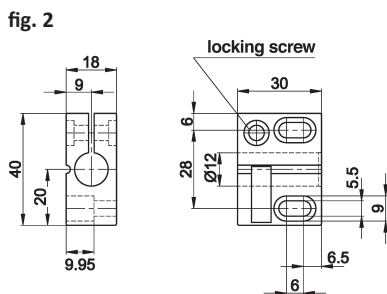

article-no.	description	sensor-diameter	material article / screw	number included in set	fig.
AY000044	quick clip	4mm	PA6 / galv. steel	3	1
AY000045	quick clip	5mm	PA6 / galv. steel	3	1
AY000046	quick clip	6.5mm	PA6 / galv. steel	5	1
AY000047	quick clip	8mm	PA6 / galv. steel	5	1
AY000048	quick clip with permanent stop (detail a)	8mm	PA6 / galv. steel	2	1
AY000049	quick clip	12mm	PA6 / galv. steel	5	2
AY000050	quick clip with permanent stop (detail a)	12mm	PA6 / galv. steel	2	2
AY000051	quick clip	18mm	PA6 / galv. steel	5	3
AY000052	quick clip with permanent stop (detail a)	18mm	PA6 / galv. steel	2	3
AY000061	quick clip	30mm	PA6 / galv. steel	-	4
AY000062	quick clip with permanent stop (detail a)	30mm	PA6 / galv. steel	-	4
AY000053	straight base for quick clip	12mm, 18mm	PA6 / galv. steel	5	5
AY000054	angular base for quick clip	12mm, 18mm	PA6 / galv. steel	3	6
AY000055	quick clip identification labels (77pcs.)	12 ... 30mm	plastic / -	1	w/o
AY000057	box set with selection of quick clips	4 ... 18mm	plastic / -	see above	7

fig. 7

