

dimensions	M5x0.5 M8x1 M12x1	
flush	switching distance	40mm

- ✓ metal sleeve made of stainl. steel
- ✓ LED display
- ✓ integrated amplifier
- ✓ threaded devices acc. to European standards
- ✓ high switching frequency and switching distances
- ✓ connection via cable, M8- or M12-connector

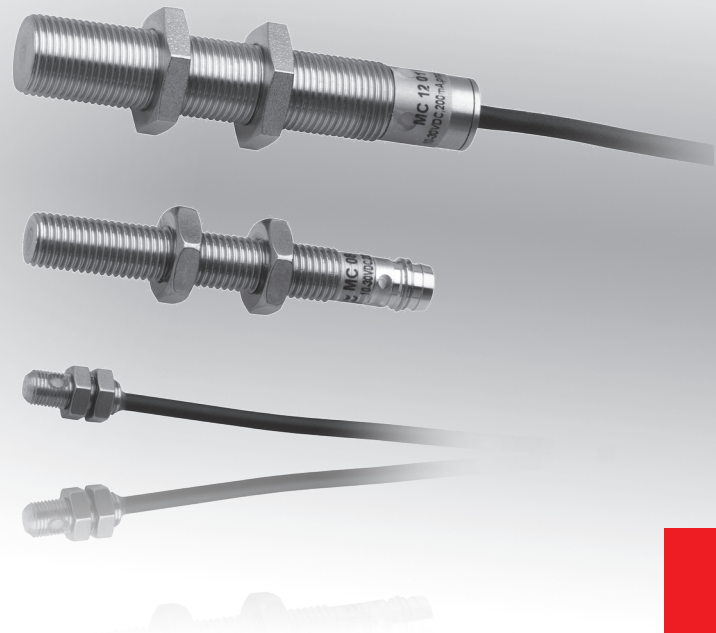

**very small, M5x0.5mm
temperature up to +130°C**

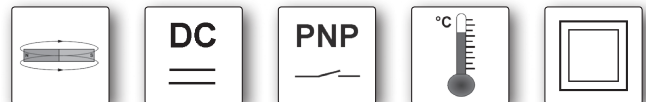

description

These magnetic sensors are used for contactless and wear-free position detection in control technology. They are used everywhere inductive proximity switches are pushed to their limits. Compared to inductive sensors, they offer a much larger switching distance.

Even the smallest version M5x0.5 features a switching distance of 40mm to the **AM000009** magnets. With appropriate magnets, even larger switching distances can be realized.

The object to be detected must be provided with a magnet, as the sensors only respond to magnets. Because magnetic fields penetrate all non-magnetizable materials, the sensors are able to detect magnets through, e.g., walls made of non-ferrous metal, stainless steel, aluminum, plastic or wood.

The **MC120125** offers the possibility to set the magnetic sen-

sitivity in a range from 1.5mT to 10mT.

The setting is performed by applying a positive voltage for at least 1 second on PIN2 of the M12-connector. This is indicated by the flashing of the LED in the sensor.

When the programming voltage is switched off, the current measured value is stored. The sensor switches if the magnetic field is greater than or equal to the „taught“ value.

application examples

- ▶ position recognition from the outside through stainless steel tubes
- ▶ speed sensing with rotating shafts
- ▶ position sensing on chain guides
- ▶ sensing of door positions

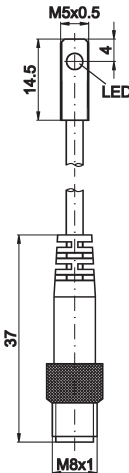
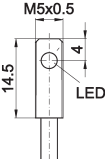
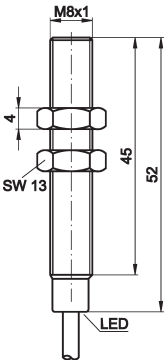
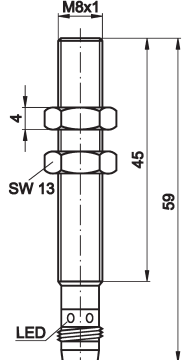
article-no.	MC050176	MC0501A6	MC080100	MC080170
version	-	-	-	-
output signal	npn, no	npn, no	npn, no	npn, no
connection	cable connector	cable	cable	M8-connector
operating temperature	-25 ... +70°C	-25 ... +70°C	-25 ... +70°C	-25 ... +70°C
				

TECHNICAL DATA

switching distance *	40mm	40mm	40mm	40mm
output signal	npn, no	npn, no	npn, no	npn, no
operating voltage	8 ... 30V DC	8 ... 30V DC	8 ... 30V DC	8 ... 30V DC
current consumption (w/o load)	≤ 20mA	≤ 20mA	≤ 20mA	≤ 20mA
output current (max. load)	150mA	150mA	200mA	200mA
voltage drop (max. load)	2.0V DC	2.0V DC	2.0V DC	2.0V DC
hysteresis	5 ... 15%	5 ... 15%	5 ... 15%	5 ... 15%
switching frequency	1kHz	1kHz	1kHz	1kHz
display (signal)	yellow LED	yellow LED	yellow LED	yellow LED
short-circuit protection	+	+	+	+
reverse polarity protection	+	+	+	+
housing material	stainl. steel	stainl. steel	stainl. steel	stainl. steel
dimensions	M5x0.5	M5x0.5	M8x1	M8x1
length (thread/complete)	14.5mm/14.5mm	14.5mm/14.5mm	45mm/52mm	45mm/59mm
operating temperature	-25 ... +70°C	-25 ... +70°C	-25 ... +70°C	-25 ... +70°C
degree of protection (EN 60529)	IP67	IP67	IP67	IP67
connection	M8-cable connector, 3-pin	2m PUR cable, 3-wire	2m PUR cable, 3-wire	M8-connector, 3-pin
connection accessories	e.g. VK200075	-	-	e.g. VK200075
mounting accessories (universal holder)	AY000115	AY000115	AY000115	AY000115
mounting accessories (clip)	AY000045	AY000045	AY000047	AY000047

* with respect to magnets
AM000009

article-no.	MC120100	MC120120	MC120125	MC120155
version	-	-	teach-in	-
output signal	pnnp, no	pnnp, no	pnnp, no	pnnp, no
connection	cable	M12-connector	M12-connector	cable
operating temperature	-25 ... +70°C	-25 ... +70°C	-25 ... +70°C	-25 ... +130°C
article-no.	MC120200	MC120420	-	-
output signal	pnnp, nc	pnnp, no/nc	-	-
connection	cable	M12-connector	-	-
operating temperature	-25 ... +70°C	-25 ... +70°C	-	-

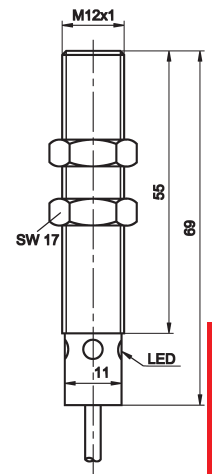
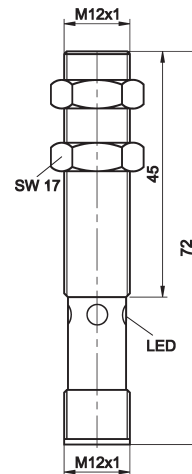
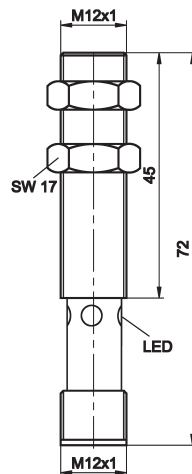
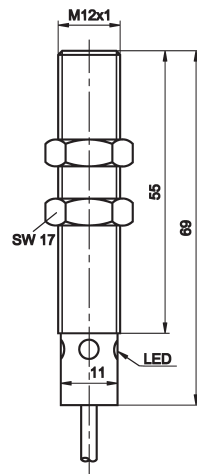

TECHNICAL DATA

switching distance *	40mm	40mm	40mm	40mm
output signal	see above	see above	pnnp, no	pnnp, no
operating voltage	8 ... 30V DC	8 ... 30V DC	10 ... 30V DC	18 ... 30V DC
current consumption (w/o load)	≤ 20mA	≤ 20mA	≤ 20mA	≤ 20mA
output current (max. load)	200mA	200mA	200mA	100mA
voltage drop (max. load)	2.0V DC	2.0V DC	2.0V DC	2.0V DC
hysteresis	5 ... 15%	5 ... 15%	5 ... 15%	5 ... 15%
switching frequency	1kHz	1kHz	1kHz	1kHz
display (signal)	yellow LED	yellow LED	yellow LED	yellow LED
short-circuit protection	+	+	+	+
reverse polarity protection	+	+	+	+
housing material	stainl. steel	stainl. steel	stainl. steel	stainl. steel
dimensions	M12x1	M12x1	M12x1	M12x1
length (thread/complete)	55mm/69mm	45mm/72mm	45mm/72mm	55mm/69mm
operating temperature	-25 ... +70°C	-25 ... +70°C	-25 ... +70°C	-25 ... +130°C
degree of protection (EN 60529)	IP67	IP67	IP67	IP67
connection	2m PUR cable, 3-wire	M12-connector, 3-/4-pin	M12-connector, 4-pin	2m silicone cable, 3-wire
connection accessories	-	e.g. VK200025 e.g. VK200325	e.g. VK200325	-
mounting accessories (universal holder)	AY000115	AY000115	AY000115	AY000115
mounting accessories (clip)	AY000049	AY000049	AY000049	AY000049

* with respect to magnets
AM000009

connection

M5, M8, M12 cable device

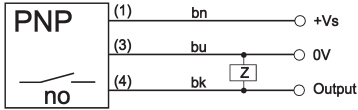

M12 connector device, teach-in

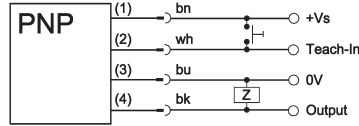

wire colors: bn = brown (1), wh = white (2), bu = blue (3), bk = black (4)

universal mounting AY000115 consisting of base module

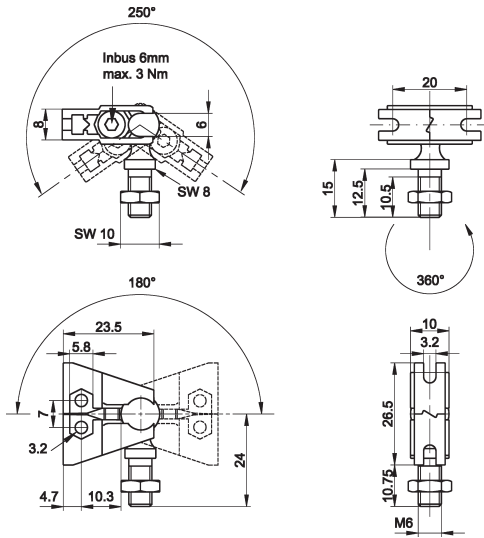

... and fitting panel

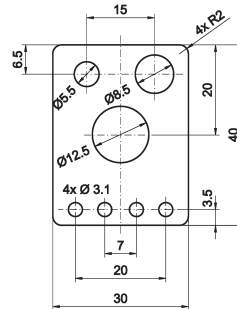

ACCESSORIES

ARTICLE-NO.	description	dimensions	note
AY000088	base module *		flanges: stainless steel, ball pins: galvanized steel
AY000115	mounting kit for M5, M8, M12 sensors		stainless steel
AY000045	quick clip	Ø 5mm	PA6 / galvanized steel bolts
AY000047	quick clip	Ø 8mm	PA6 / galvanized steel bolts
AY000048	quick clip with positive stop	Ø 8mm	PA6 / galvanized steel bolts
AY000049	quick clip	Ø 12mm	PA6 / galvanized steel bolts
AY000050	quick clip with positive stop	Ø 12mm	PA6 / galvanized steel bolts
AM000001	magnet, barium ferrite	20 round / length 6.5mm	bore 4.3 mm
AM000002	magnet, barium ferrite	30 round / length 15mm	bore 5.6 mm
AM000009	magnet, barium ferrite	30 round / length 10mm	can be fastened with adhesive
AM000010	magnet, plastic cover	35 round / length 17mm	bore 5.6 mm
AM000020	magnet, Neodelta	10 round / length 3mm	can be fastened with adhesive

* The **AY000088** base module is contained in every mounting kit.
Material of bolts and nuts: galvanized steel

This data sheet only contains the available standard variants. For other output / connection variants, we kindly ask that you contact us.

We are happy to supply the right cable socket for the plug equipment. You will find a list in the "accessories" section of the catalog under **ipf-SENSORFLEX**® "cable sockets" or in the search window on our homepage www.ipf-electronic.com (using the search term "VK").

Warning: Never use these devices in applications where the safety of a person depends on their functionality.

This data sheet as well as your personal contact can be found at www.ipf-electronic.com