

**OY410020**

**OPTICAL SENSORS • LIGHT BARRIERS**

The multi-function light barriers are through-beam sensors where multiple beams are integrated. In case of interruption of only one beam, the switching output of the receiver changes its state. The devices are used where standard through-beam sensors with only one beam are not sufficient. There are devices with beam spacing of 20, 40, 60 or 120mm and different heights available. An integrated fuzzy logic controls the transmitting power automatically.



**MECHANICAL DATA**

Ambient temperature (MAX)	50 °C
Ambient temperature (MIN)	-5 °C
Cable length	0.3 m
Cover material	Plastic
Degree of protection (IP)	IP65
Housing material	Aluminium
Material of optical surface	PMMA
Number of wires	4
Protected field height	232 mm
Sensor height	260 mm
Sensor length	20.5 mm
Sensor width	40 mm

**ELECTRICAL DATA**

Cascadable	No
Clock control possible	No
No-load current, receiver	100 mA
No-load current, transmitter	100 mA
Number of pins	4
Number of pins, receiver	4
Number of pins, transmitter	4
Override possible	No
Rated control supply voltage $U_s$ at DC (MAX)	26.4 V
Rated control supply voltage $U_s$ at DC (MIN)	21.6 V
Reaction time	4 ms
Reverse polarity protection	Yes
Short-circuit-proof	Yes
Suitable for safety functions	No
Suppression possible	No
Type of analog output	0 V ... 10 V / 4 mA ... 20 mA
Type of electrical connection	Cable with connector

## ELECTRICAL DATA

Voltage type	DC
With monitoring function of downstream devices	No
With muting function	No
With restart lock	No

## OPTICAL DATA

Min. distance	0.3 m
Protected field range	4 m
Resolution of the light curtain	4 mm

## OTHER DATA

Explosion protection category for dust	None
Explosion protection category for gas	None
Reduced resolution	No
Scope of delivery of the one-way system	Transmitter and receiver
With beam coding	No

## CONNECTION

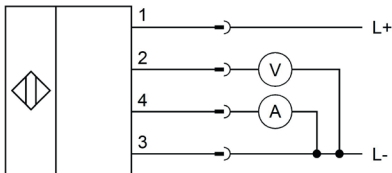

**Colors:** 1 = BN (brown), 2 = WH (white), 3 = BU (blue), 4 = BK (black)

**Functions:** 1 = L+, 2 = 0-10V, 3 = L-, 4 = 4-20mA

## DIMENSIONAL DRAWING

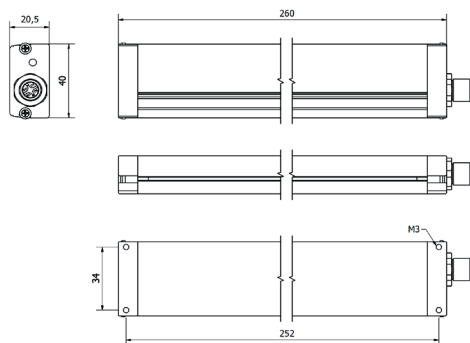

## INSTALLATION



Mounting / Installation may only be carried out by a qualified electrician!

## DISPOSAL



## SAFETY WARNINGS

Before initial operation, please make sure to follow all safety instructions that may be provided in the product information!

Never use these devices in applications where the safety of a person depends on their functionality.