

up to 3-fold norm switching distance

plus-series

NOTES

A large grid area for taking notes, consisting of a 20x30 grid of small squares. The grid is empty and occupies the majority of the page below the 'NOTES' header.

dimensions	3round M4x0.5 4round M5x0.5 6.5round M8x1 M12x1 M18x1 M30x1.5	
flush	switching distance	1 to 1.5mm
semi-flush	switching distance	3 to 22mm
non-flush	switching distance	6 to 40mm

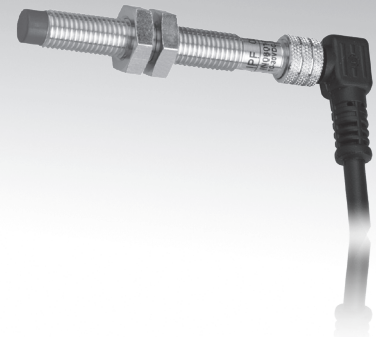
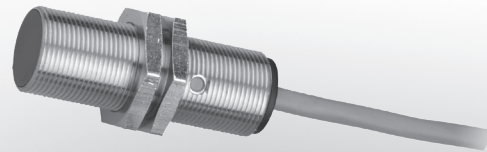

- ✓ metal sleeve made of stainl. steel or chrome-plated brass
- ✓ LED display
- ✓ integrated amplifier
- ✓ threaded devices acc. to European standards
- ✓ high switching frequency and switching distances
- ✓ connection via cable and M8/M12-connector

**up to 3-fold norm switching distance
robust metal housing**



description

ipf electronic's plus series inductive proximity switches are characterized by long switching distances. The devices work in a way which is similar to conventional proximity switches. However the oscillator and the downstream signal evaluation unit are configured differently, whereby significantly better stability is achieved in terms of temperature. This enables the switching point to be rescheduled so that longer switching distances are achieved.

Plus series devices are preferably put to use in applications where a long switching distance has to be achieved, but the space does not allow for a correspondingly large standard device. Further fields of application can be found where the limited switching distance of standard sensors do not guarantee reliable operation, e.g. when detecting sheet metal parts

with large mechanical tolerances.

For attaining the maximum switching distance, attention should be paid concerning the size of the object (norm measuring plate) and the kind of surface (level surface). For the reliable operation of the devices, it is essential that the installation conditions on the following pages are adhered to.

application examples

- ▶ inspection of die-cut metal parts of various sizes using different switching distances
- ▶ integration, even in machine parts
- ▶ detection of objects through the walls of non-metallic containers and tubes

Notes on inductive proximity switches

I	inductive sensor
IB	<u>f</u> lush
IN	<u>n</u> on-flush

functional principle

The oscillation coil behind the active surface of the proximity switch produces an alternating electromagnetic field. Any electrically conductive material entering the field will induce rotational currents extracting energy from the oscillating circuit. The damping of the oscillator is then converted into a switching signal in the output amplifier.

It follows the functional principle that all metals are detected, moving or not. Important: The high frequency field produces no measurable increase in temperature and no magnetic influence inside the object to be detected. That means the sensors operate without interacting with the system.

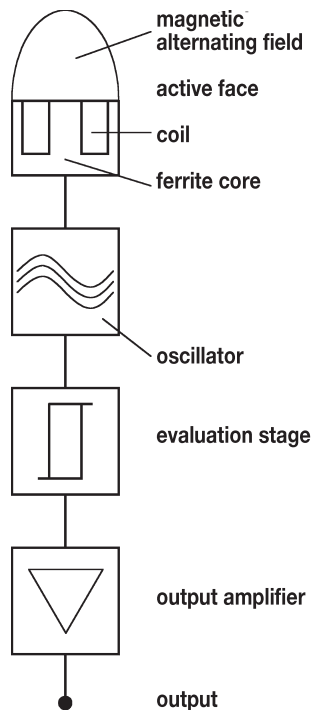

functional principle of an inductive proximity switch

switching distance / norm measuring plate

The distance to the sensor surface, where a metal causes a change in the switching state, is called switching distance. This distance is not the same for all metals. That is why a so-called correction factor has been specified for the respective metal, e.g. copper or aluminum. The nominal switching distance S_n is determined by a norm measuring plate. This is a quadratic metal plate made from steel (St37) with a thickness of 1mm and a smoothed surface. The edge length is $3 \times S_n$ if $3 \times S_n$ is larger than the diameter of the active surface, otherwise the edge length is the same as the diameter of the active surface.

One differentiates between the normal switching distance S_n , which is determined without consideration for manufacturing tolerances or external influences, and the operational switching distance S_a .

The safe operational switching distance is between 0 and 81% of S_n ($0 < S_a < 0.81 \times S_n$).

switching hysteresis

During the approach and subsequent removal of the measuring plate from the initiator there will be a difference between switch-on point and switch-off point. This integrated hysteresis prevents the switching output from oscillating during mechanical vibrations. Usually the hysteresis is between 5 to 15% of S_n .

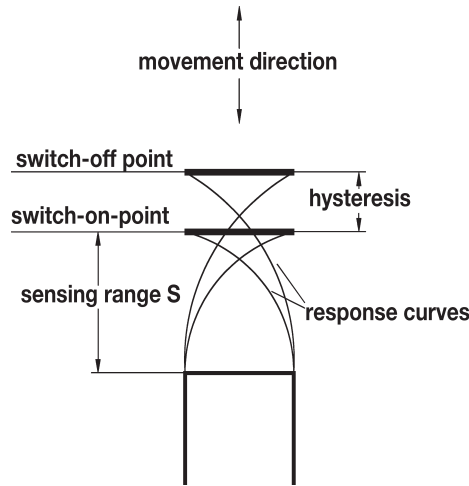

series connection

To be operationally safe the connection in series of 3-wire PNP sensors requires a logical AND-gate, e.g. **VL250100**.

parallel connection

A logical OR-gate, e.g. the **VL250120**, can be used to facilitate the connection in parallel.

mounting

For the reliable operation of the devices, it is essential that the installation conditions are adhered to.

switching frequency

The switching frequency states the maximum number of available switching operations per second. Every switching operation of the inductive proximity switch causes the oscillating circuit to move.

The time needed for the oscillation puts a limit on the switching frequency.

For half the nominal switching distance the pulse to pause ratio should be at least 1 : 2,

i.e. when choosing the right proximity switch, a compromise needs to be made between the size of the sensor and the switching frequency. General rule: The larger the sensor, the lower the switching frequency.

tightening torques

To avoid damage when mounting proximity switches, never exceed the specified tightening torques.

stainless steel thread

- M4 = 0.8Nm
- M5 = 1.5Nm
- M8 = 6Nm
- M12 = 20Nm
- M18 = 50Nm

chrome-plated brass thread

- M8 = 4Nm
- M12 = 10Nm
- M18 = 25Nm
- M30 = 70Nm

active switching zone / active surface:

The active switching zone is the area in front of the active surface, within which the proximity switch reacts to the approach of metal parts, i.e. changes the state of the output.

nominal switching distance (S_n):

The distance at which a metal part that is approaching the active surface of the proximity switch causes a status change in the state of the switching output.

output function:

normally open: Object within the area of the active switching zone – output switched

normally closed: Object within the area of the active switching zone – output inhibited

readiness delay:

Time required by the proximity switch to be functional after the supply voltage is applied (lies in the millisecond range).

repeat accuracy

The repeat accuracy (according to IEC 60947-5-2 / EN 60947-5-2) is the repeat accuracy of the real switching distance S_r over a period of 8 hours at an ambient temperature of (23 ± 5)°C and a defined operating voltage V_s. The specified repeat accuracy corresponds to this definition. Generally the repeat accuracy is considerably better in case of sequent measurements.

reverse polarity protection:

An internal protection prevents destruction of the proximity switch if the connection lines are accidentally swapped.

short-circuit protection:

An internal protection prevents destruction of the proximity switch in case of an overcurrent.

Warning: Never use these devices in applications where the safety of a person depends on their functionality.

article-no.	IBR30106	IBR30176	IB040106	IB040176
output signal	pnnp, no	pnnp, no	pnnp, no	pnnp, no
switching distance	1mm	1mm	1mm	1mm
version	Ø 3mm	Ø 3mm	M4x0.5	M4x0.5
mounting	flush	flush	flush	flush
connection	2m PUR cable	M8 cable connector	2m PUR cable	M8 cable connector
article-no.	IBR30206	IBR30276	IB040206	IB040276
output signal	pnnp, nc	pnnp, nc	pnnp, nc	pnnp, nc
article-no.	*	*	*	*
output signal	nnp, no	nnp, no	nnp, no	nnp, no
article-no.	*	*	*	*
output signal	nnp, nc	nnp, nc	nnp, nc	nnp, nc
* on request				
TECHNICAL DATA				
switching distance (Sn)	1mm	1mm	1mm	1mm
output signal	see above	see above	see above	see above
operating voltage	10 ... 30V DC	10 ... 30V DC	10 ... 30V DC	10 ... 30V DC
current consumption (w/o load)	≤ 10mA	≤ 10mA	≤ 10mA	≤ 10mA
output current (max. load)	100mA	100mA	100mA	100mA
voltage drop (max. load)	2.0V DC	2.0V DC	2.0V DC	2.0V DC
norm measuring plate	3x3x1mm, FE360	3x3x1mm, FE360	4x4x1mm, FE360	4x4x1mm, FE360
hysteresis	typ. < 10%	typ. < 10%	typ. < 10%	typ. < 10%
repeat accuracy	0.02mm	0.02mm	0.02mm	0.02mm
correction factors (St37/Alu/Ms)	1.0 / 0.5 / 0.6	1.0 / 0.5 / 0.6	1.0 / 0.5 / 0.6	1.0 / 0.5 / 0.6
correction factors (stainl. steel/Cu)	0.8 / 0.45	0.8 / 0.45	0.8 / 0.45	0.8 / 0.45
switching frequency	3kHz	3kHz	3kHz	3kHz
display (signal)	yellow LED	yellow LED	yellow LED	yellow LED
short-circuit protection	+	+	+	+
reverse polarity protection	+	+	+	+
dimensions	Ø 3mm	Ø 3mm	M4x0.5	M4x0.5
housing material	stainless steel 1.4305	stainless steel 1.4305	stainless steel 1.4305	stainless steel 1.4305
length (thread/complete)	- / 22mm	- / 22mm	16mm / 22mm	16mm / 22mm
operating temperature	-25 ... +70°C	-25 ... +70°C	-25 ... +70°C	-25 ... +70°C
degree of protection (EN 60529)	IP67	IP67	IP67	IP67
connection	2m PUR cable	M8 cable connector 3-pin	2m PUR cable	M8 cable connector 3-pin
connection accessories	-	e.g. VK200075	-	e.g. VK200075
mounting accessories (clip)	-	-	AY000044	AY000044

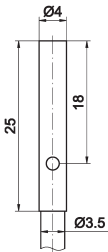
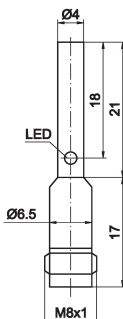
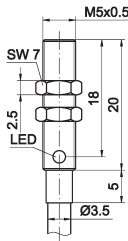
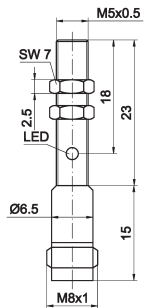
article-no.	IBR40106	IBR40176	IB050106	IB050176
output signal	pnnp, no	pnnp, no	pnnp, no	pnnp, no
switching distance	1.5mm	1.5mm	1.5mm	1.5mm
version	Ø 4mm	Ø 4mm	M5x0.5	M5x0.5
mounting	flush	flush	flush	flush
connection	5m PVC-cable	M8-connector	5m PVC-cable	M8-connector
article-no.	IBR40206	*	IB050206	IB050276
output signal	pnnp, nc	pnnp, nc	pnnp, nc	pnnp, nc
article-no.	*	*	*	*
output signal	nnp, no	nnp, no	nnp, no	nnp, no
article-no.	*	*	*	*
output signal	nnp, nc	nnp, nc	nnp, nc	nnp, nc
* on request				
				
TECHNICAL DATA				
switching distance (Sn)	1.5mm	1.5mm	1.5mm	1.5mm
output signal	see above	see above	see above	see above
operating voltage	10 ... 30V DC	10 ... 30V DC	10 ... 30V DC	10 ... 30V DC
current consumption (w/o load)	≤ 10mA	≤ 10mA	≤ 10mA	≤ 10mA
output current (max. load)	200mA	200mA	200mA	200mA
voltage drop (max. load)	2.0V DC	2.0V DC	2.0V DC	2.0V DC
norm measuring plate	4.5x4.5x1mm, FE360	4.5x4.5x1mm, FE360	5x5x1mm, FE360	5x5x1mm, FE360
hysteresis	typ. < 10%	typ. < 10%	typ. < 10%	typ. < 10%
repeat accuracy	0.03mm	0.03mm	0.03mm	0.03mm
correction factors (St37/Alu/Ms)	1.0 / 0.4 / 0.5	1.0 / 0.4 / 0.5	1.0 / 0.4 / 0.5	1.0 / 0.4 / 0.5
correction factors (stainl. steel/Cu)	0.75 / 0.4	0.75 / 0.4	0.75 / 0.4	0.75 / 0.4
switching frequency	3kHz	3kHz	3kHz	3kHz
display (signal)	yellow LED	yellow LED	yellow LED	yellow LED
short-circuit protection	+	+	+	+
reverse polarity protection	+	+	+	+
dimensions	Ø 4mm	Ø 4mm	M5x0.5	M5x0.5
housing material	stainless steel 1.4305	stainless steel 1.4305	stainless steel 1.4305	stainless steel 1.4305
length (thread/complete)	- / 25mm	- / 38mm	20mm / 25mm	23mm / 38mm
operating temperature	-25 ... +70°C	-25 ... +70°C	-25 ... +70°C	-25 ... +70°C
degree of protection (EN 60529)	IP67	IP67	IP67	IP67
connection	5m PUR cable	M8-connector, 3-pin	5m PUR cable	M8-connector, 3-pin
connection accessories	-	e.g. VK200075	-	e.g. VK200075
mounting accessories (clip)	AY000044	AY000044	AY000045	AY000045
mounting accessories (universal holder)	-	-	AY000115	AY000115

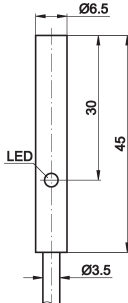
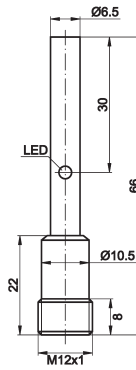
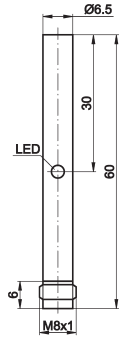
article-no.	IB060106	IB060126	IB060176
output signal	pnp, no	pnp, no	pnp, no
switching distance	3mm	3mm	3mm
version	Ø 6.5mm	Ø 6.5mm	Ø 6.5mm
mounting	semi-flush	semi-flush	semi-flush
connection	2m PVC-cable	M12-connector	M8 connector
article-no.	IB060206	*	IB060276
output signal	pnp, nc	pnp, nc	pnp, nc
article-no.	*	*	*
output signal	npn, no	npn, no	npn, no
article-no.	*	*	*
output signal	npn, nc	npn, nc	npn, nc
* on request			
			
TECHNICAL DATA			
switching distance (Sn)	3mm	3mm	3mm
output signal	see above	see above	see above
operating voltage	10 ... 30V DC	10 ... 30V DC	10 ... 30V DC
current consumption (w/o load)	≤ 10mA	≤ 10mA	≤ 10mA
output current (max. load)	200mA	200mA	200mA
voltage drop (max. load)	2.0V DC	2.0V DC	2.0V DC
norm measuring plate	9x9x1mm, FE360	9x9x1mm, FE360	9x9x1mm, FE360
hysteresis	typ. < 10%	typ. < 10%	typ. < 10%
repeat accuracy	0.15mm	0.15mm	0.15mm
correction factors (St37/Alu/Ms)	1.0 / 0.26 / 0.35	1.0 / 0.26 / 0.35	1.0 / 0.26 / 0.35
correction factors (stainl. steel/Cu)	0.67 / 0.18	0.67 / 0.18	0.67 / 0.18
switching frequency	1kHz	1kHz	1kHz
display (signal)	yellow LED	yellow LED	yellow LED
short-circuit protection	+	+	+
reverse polarity protection	+	+	+
dimensions	Ø 6.5mm	Ø 6.5mm	Ø 6.5mm
housing material	chrome-plated brass	chrome-plated brass	chrome-plated brass
length (thread/complete)	- / 45mm	- / 66mm	- / 60mm
operating temperature	-25 ... +70°C	-25 ... +70°C	-25 ... +70°C
degree of protection (EN 60529)	IP67	IP67	IP67
connection	2m PVC-cable	M12-connector, 3-pin	M12-connector, 3-pin
connection accessories	-	e.g. VK200025	e.g. VK200075
mounting accessories (clip)	AY000046	AY000046	AY000046

article-no.	IB080106	IB080126	IB080176
output signal	pnnp, no	pnnp, no	pnnp, no
switching distance	3mm	3mm	3mm
version	M8x1	M8x1	M8x1
mounting	semi-flush	semi-flush	semi-flush
connection	2m PVC-cable	M12-connector	M8 connector
article-no.	IB080206	IB080226	IB080276
output signal	pnnp, nc	pnnp, nc	pnnp, nc
article-no.	IB081106	*	IB081176
output signal	npn, no	npn, no	npn, no
article-no.	*	*	*
output signal	npn, nc	npn, nc	npn, nc

* on request

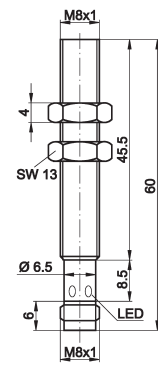
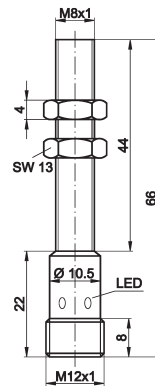
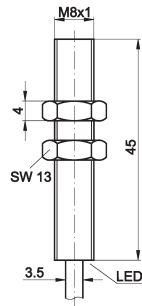

TECHNICAL DATA

switching distance (Sn)	3mm	3mm	3mm
output signal	see above	see above	see above
operating voltage	10 ... 30V DC	10 ... 30V DC	10 ... 30V DC
current consumption (w/o load)	≤ 10mA	≤ 10mA	≤ 10mA
output current (max. load)	200mA	200mA	200mA
voltage drop (max. load)	2.0V DC	2.0V DC	2.0V DC
norm measuring plate	9x9x1mm, FE360	9x9x1mm, FE360	9x9x1mm, FE360
hysteresis	typ. < 10%	typ. < 10%	typ. < 10%
repeat accuracy	0.15mm	0.15mm	0.15mm
correction factors (St37/Alu/Ms)	1.0 / 0.33 / 0.41	1.0 / 0.33 / 0.41	1.0 / 0.33 / 0.41
correction factors (stainl. steel/Cu)	0.72 / 0.27	0.72 / 0.27	0.72 / 0.27
switching frequency	1kHz	1kHz	1kHz
display (signal)	yellow LED	yellow LED	yellow LED
short-circuit protection	+	+	+
reverse polarity protection	+	+	+
dimensions	M8x1	M8x1	M8x1
housing material	chrome-plated brass	chrome-plated brass	chrome-plated brass
length (thread/complete)	45mm / 45mm	44mm / 66mm	45mm / 60mm
operating temperature	-25 ... +70°C	-25 ... +70°C	-25 ... +70°C
degree of protection (EN 60529)	IP67	IP67	IP67
connection	2m PVC-cable	M12-connector, 3-pin	M8 connector, 3-pin
connection accessories	-	e.g. VK200025	e.g. VK200075
mounting accessories (clip)	AY000047	AY000047	AY000047
mounting accessories (universal holder)	AY000115	AY000115	AY000115

article-no.	IN080106	IN080126	IN080176
output signal	pnp, no	pnp, no	pnp, no
switching distance	6mm	6mm	6mm
version	M8x1	M8x1	M8x1
mounting	non-flush	non-flush	non-flush
connection	2m PVC-cable	M12-connector	M8 connector
article-no.	IN080206	IN080226	IN080276
output signal	pnp, nc	pnp, nc	pnp, nc
article-no.	*	*	IN081176
output signal	npn, no	npn, no	npn, no
article-no.	*	*	*
output signal	npn, nc	npn, nc	npn, nc
* on request			
TECHNICAL DATA			
switching distance (Sn)	6mm	6mm	6mm
output signal	see above	see above	see above
operating voltage	10 ... 30V DC	10 ... 30V DC	10 ... 30V DC
current consumption (w/o load)	≤ 10mA	≤ 10mA	≤ 10mA
output current (max. load)	200mA	200mA	200mA
voltage drop (max. load)	2.0V DC	2.0V DC	2.0V DC
norm measuring plate	18x18x1mm, FE360	18x18x1mm, FE360	18x18x1mm, FE360
hysteresis	typ. < 10%	typ. < 10%	typ. < 10%
repeat accuracy	0.3mm	0.3mm	0.3mm
correction factors (St37/Alu/Ms)	1.0 / 0.47 / 0.55	1.0 / 0.47 / 0.55	1.0 / 0.47 / 0.55
correction factors (stainl. steel/Cu)	0.77 / 0.44	0.77 / 0.44	0.77 / 0.44
switching frequency	500Hz	500Hz	500Hz
display (signal)	yellow LED	yellow LED	yellow LED
short-circuit protection	+	+	+
reverse polarity protection	+	+	+
dimensions	M8x1	M8x1	M8x1
housing material	chrome-plated brass	chrome-plated brass	chrome-plated brass
length (thread/complete)	41mm / 45mm	42mm / 66mm	41mm / 60mm
operating temperature	-25 ... +70°C	-25 ... +70°C	-25 ... +70°C
degree of protection (EN 60529)	IP67	IP67	IP67
connection	2m PVC-cable	M12-connector, 3-pin	M8 connector, 3-pin
connection accessories	-	e.g. VK200025	e.g. VK200075
mounting accessories (clip)	AY000047	AY000047	AY000047
mounting accessories (universal holder)	AY000115	AY000115	AY000115

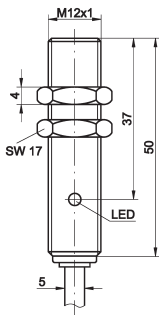
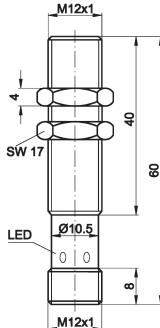
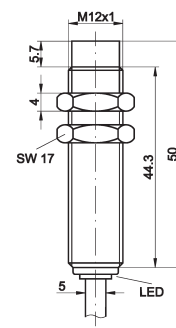
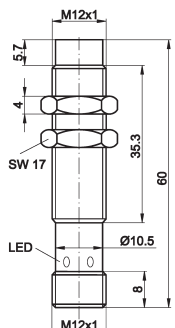
article-no.	IB120106	IB120126	IN120106	IN120126
output signal	pnnp, no	pnnp, no	pnnp, no	pnnp, no
switching distance	6mm	6mm	10mm	10mm
version	M12x1	M12x1	M12x1	M12x1
mounting	semi-flush	semi-flush	non-flush	non-flush
connection	2m PVC-cable	M12-connector	2m PVC-cable	M12-connector
article-no.	*	IB120226	IN120206	IN120226
output signal	pnnp, nc	pnnp, nc	pnnp, nc	pnnp, nc
article-no.	*	IB121126	IN121106	IN121126
output signal	nnp, no	nnp, no	nnp, no	nnp, no
article-no.	*	*	*	*
output signal	nnp, nc	nnp, nc	nnp, nc	nnp, nc
* on request				
				
TECHNICAL DATA				
switching distance (Sn)	6mm	6mm	10mm	10mm
output signal	see above	see above	see above	see above
operating voltage	10 ... 30V DC	10 ... 30V DC	10 ... 30V DC	10 ... 30V DC
current consumption (w/o load)	≤ 10mA	≤ 10mA	≤ 10mA	≤ 10mA
output current (max. load)	200mA	200mA	200mA	200mA
voltage drop (max. load)	2.0V DC	2.0V DC	2.0V DC	2.0V DC
norm measuring plate	18x18x1mm, FE360	18x18x1mm, FE360	30x30x1mm, FE360	30x30x1mm, FE360
hysteresis	typ. < 10%	typ. < 10%	typ. < 10%	typ. < 10%
repeat accuracy	0.3mm	0.3mm	0.3mm	0.3mm
correction factors (St37/Alu/Ms)	1.0 / 0.3 / 0.40	1.0 / 0.3 / 0.40	1.0 / 0.49 / 0.56	1.0 / 0.49 / 0.56
correction factors (stainl. steel/Cu)	0.7 / 0.25	0.7 / 0.25	0.77 / 0.45	0.77 / 0.45
switching frequency	800Hz	800Hz	400Hz	400Hz
display (signal)	yellow LED	yellow LED	yellow LED	yellow LED
short-circuit protection	+	+	+	+
reverse polarity protection	+	+	+	+
dimensions	M12x1	M12x1	M12x1	M12x1
housing material	chrome-plated brass	chrome-plated brass	chrome-plated brass	chrome-plated brass
length (thread/complete)	50mm / 50mm	40mm / 60mm	44mm / 50mm	35mm / 60mm
operating temperature	-25 ... +70°C	-25 ... +70°C	-25 ... +70°C	-25 ... +70°C
degree of protection (EN 60529)	IP67	IP67	IP67	IP67
connection	2m PVC-cable	M12-connector, 3-pin	2m PUR cable	M12-connector, 3-pin
connection accessories	-	e.g. VK200025	-	e.g. VK200025
mounting accessories (clip)	AY000049	AY000049	AY000049	AY000049
mounting accessories (universal holder)	AY000115	AY000115	AY000115	AY000115

article-no.	IB180106	IB180126	IN180106	IN180126
output signal	pnp, no	pnp, no	pnp, no	pnp, no
switching distance	12mm	12mm	20mm	20mm
version	M18x1	M18x1	M18x1	M18x1
mounting	semi-flush	semi-flush	non-flush	non-flush
connection	2m PVC-cable	M12-connector	2m PVC-cable	M12-connector
article-no.	IB180206	IB180226	IN180206	IN180226
output signal	pnp, nc	pnp, nc	pnp, nc	pnp, nc
article-no.	*	IB181126	IN181106	IN181126
output signal	npn, no	npn, no	npn, no	npn, no
article-no.	*	*	*	*
output signal	npn, nc	npn, nc	npn, nc	npn, nc
* on request				
TECHNICAL DATA				
switching distance (Sn)	12mm	12mm	20mm	20mm
output signal	see above	see above	see above	see above
operating voltage	10 ... 30V DC	10 ... 30V DC	10 ... 30V DC	10 ... 30V DC
current consumption (w/o load)	≤ 10mA	≤ 10mA	≤ 10mA	≤ 10mA
output current (max. load)	200mA	200mA	200mA	200mA
voltage drop (max. load)	2.0V DC	2.0V DC	2.0V DC	2.0V DC
norm measuring plate	36x36x1mm, FE360	36x36x1mm, FE360	60x60x1mm, FE360	60x60x1mm, FE360
hysteresis	typ. < 10%	typ. < 10%	typ. < 10%	typ. < 10%
repeat accuracy	0.6mm	0.6mm	1mm	1mm
correction factors (St37/Alu/Ms)	1.0 / 0.26 / 0.33	1.0 / 0.26 / 0.33	1.0 / 0.40 / 0.45	1.0 / 0.40 / 0.45
correction factors (stainl. steel/Cu)	0.63 / 0.20	0.63 / 0.20	0.66 / 0.35	0.66 / 0.35
switching frequency	500Hz	500Hz	200Hz	200Hz
display (signal)	yellow LED	yellow LED	yellow LED	yellow LED
short-circuit protection	+	+	+	+
reverse polarity protection	+	+	+	+
dimensions	M18x1	M18x1	M18x1	M18x1
housing material	chrome-plated brass	chrome-plated brass	chrome-plated brass	chrome-plated brass
length (thread/complete)	50mm / 50mm	42mm / 63.5mm	40mm / 50mm	32mm / 63.5mm
operating temperature	-25 ... +70°C	-25 ... +70°C	-25 ... +70°C	-25 ... +70°C
degree of protection (EN 60529)	IP67	IP67	IP67	IP67
connection	2m PVC-cable	M8-connector, 3-pin	2m PVC-cable	M12-connector, 3-pin
connection accessories	-	e.g. VK200025	-	e.g. VK200025
mounting accessories (clip)	AY000051	AY000051	AY000051	AY000051
mounting accessories (universal holder)	AY000117	AY000117	AY000117	AY000117

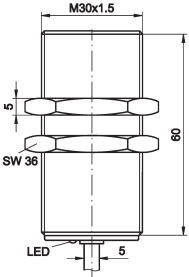
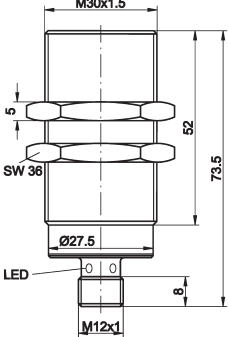
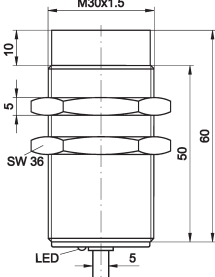
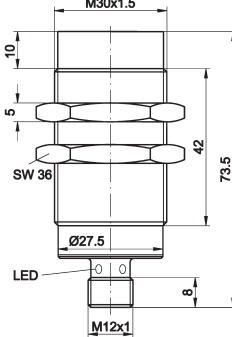
article-no.	IB300106	IB300126	IN300106	IN300126
output signal	pnp, no	pnp, no	pnp, no	pnp, no
switching distance	22mm	22mm	40mm	40mm
version	M30x1.5	M30x1.5	M30x1.5	M30x1.5
mounting	semi-flush	semi-flush	non-flush	non-flush
connection	2m PVC-cable	M12-connector	2m PVC-cable	M12-connector
article-no.	*	IB300226	*	IN300226
output signal	pnp, nc	pnp, nc	pnp, nc	pnp, nc
article-no.	IB301106	IB301126	*	IN301126
output signal	nnp, no	nnp, no	nnp, no	nnp, no
article-no.	*	*	*	*
output signal	nnp, nc	nnp, nc	nnp, nc	nnp, nc
* on request				
				
TECHNICAL DATA				
switching distance (S _n)	22mm	22mm	40mm	40mm
output signal	see above	see above	see above	see above
operating voltage	10 ... 30V DC	10 ... 30V DC	10 ... 30V DC	10 ... 30V DC
current consumption (w/o load)	≤ 10mA	≤ 10mA	≤ 10mA	≤ 10mA
output current (max. load)	100mA	100mA	100mA	100mA
voltage drop (max. load)	2.0V DC	2.0V DC	2.0V DC	2.0V DC
norm measuring plate	66x66x1mm, FE360	66x66x1mm, FE360	120x120x1mm, FE360	120x120x1mm, FE360
hysteresis	typ. < 10%	typ. < 10%	typ. < 10%	typ. < 10%
repeat accuracy	1.1mm	1.1mm	2mm	2mm
correction factors (St37/Alu/Ms)	1.0 / 0.40 / 0.45	1.0 / 0.40 / 0.45	1.0 / 0.42 / 0.47	1.0 / 0.42 / 0.47
correction factors (stainl. steel/Cu)	0.66 / 0.35	0.66 / 0.35	0.78 / 0.37	0.78 / 0.37
switching frequency	200Hz	200Hz	100Hz	100Hz
display (signal)	yellow LED	yellow LED	yellow LED	yellow LED
short-circuit protection	+	+	+	+
reverse polarity protection	+	+	+	+
dimensions	M30x1.5	M30x1.5	M30x1.5	M30x1.5
housing material	chrome-plated brass	chrome-plated brass	chrome-plated brass	chrome-plated brass
length (thread/complete)	60mm / 60mm	52mm / 73.5mm	50mm / 60mm	42mm / 73.5mm
operating temperature	-25 ... +70°C	-25 ... +70°C	-25 ... +70°C	-25 ... +70°C
degree of protection (EN 60529)	IP67	IP67	IP67	IP67
connection	2m PVC-cable	M12-connector, 3-pin	2m PVC-cable	M12-connector, 3-pin
connection accessories	-	e.g. VK200025	-	e.g. VK200025
mounting accessories (clip)	AY000061	AY000061	AY000061	AY000061

IBR301X6, IB0401X6

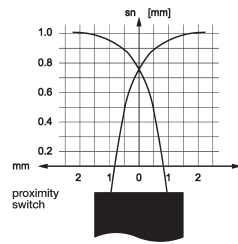
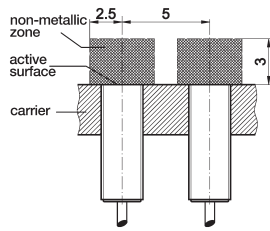

IB401X6

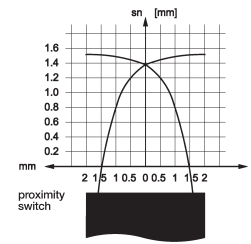
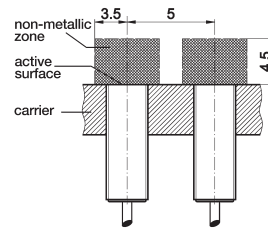

correction factors

steel (St37)	1.0	steel (St37)	1.0
stainless steel	0.8	stainless steel	0.75
aluminum	0.5	aluminum	0.4
copper	0.45	copper	0.4
brass	0.6	brass	0.5

IB0501X6

flush mounting

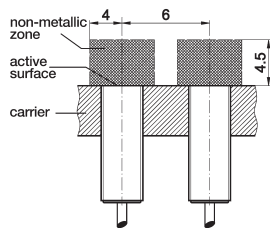

response curve

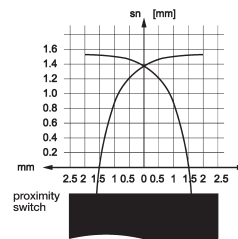

IB0601X6

flush mounting

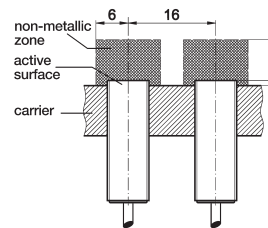

response curve

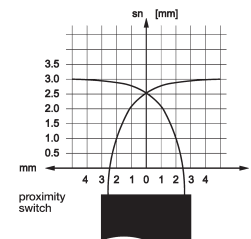

correction factors

steel (St37)	1.0	steel (St37)	1.0
stainless steel	0.75	stainless steel	0.67
aluminum	0.4	aluminum	0.26
copper	0.4	copper	0.18
brass	0.5	brass	0.35

IB0801X6

flush mounting

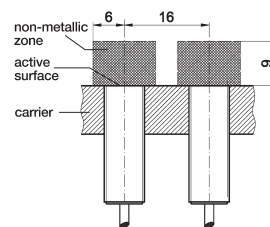

response curve

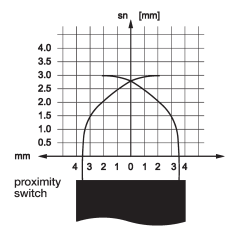

IN0801X6

non-flush mounting

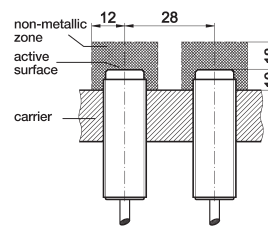

response curve

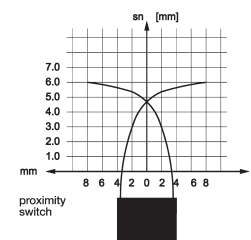

correction factors

steel (St37)	1.0	steel (St37)	1.0
stainless steel	0.72	stainless steel	0.77
aluminum	0.33	aluminum	0.47
copper	0.27	copper	0.44
brass	0.41	brass	0.55

IB1201X6

semi-flush mounting

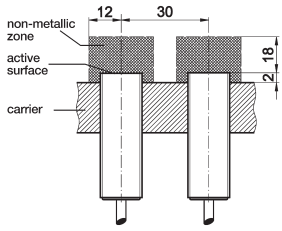

response curve

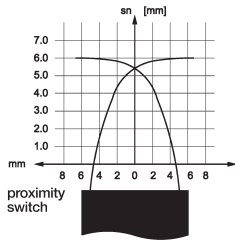

IN1201X6

non-flush mounting

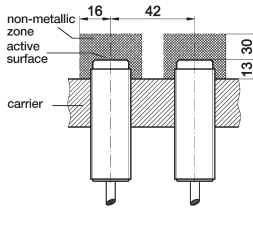

response curve

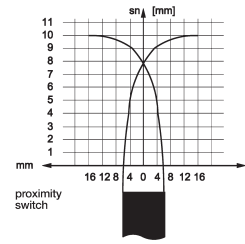

correction factors

steel (St37)	1.0	steel (St37)	1.0
stainless steel	0.70	stainless steel	0.77
aluminum	0.30	aluminum	0.49
copper	0.25	copper	0.45
brass	0.40	brass	0.56

IB1801X6

semi-flush mounting

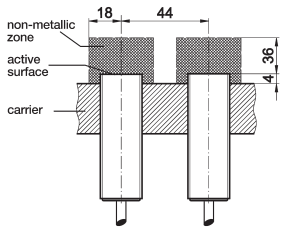

response curve

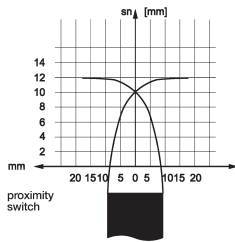

IN1801X6

non-flush mounting

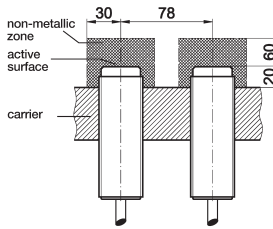

response curve

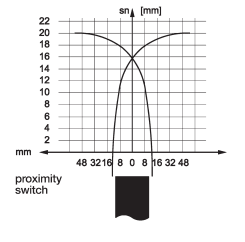

correction factors

steel (St37)	1.0	steel (St37)	1.0
stainless steel	0.63	stainless steel	0.66
aluminum	0.26	aluminum	0.4
copper	0.2	copper	0.35
brass	0.33	brass	0.45

IB3001X6

semi-flush mounting

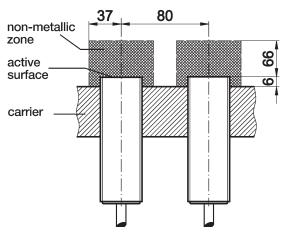

response curve

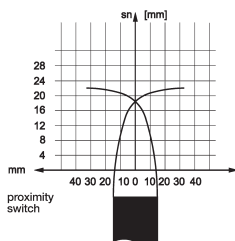

IN3001X6

non-flush mounting

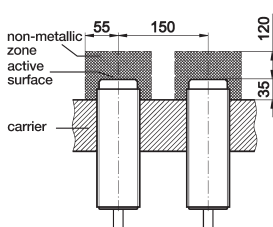

response curve

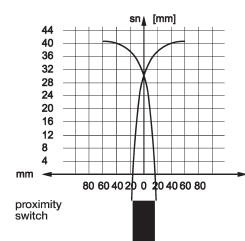

correction factors

steel (St37)	1.0	steel (St37)	1.0
stainless steel	0.66	stainless steel	0.78
aluminum	0.40	aluminum	0.42
copper	0.35	copper	0.37
brass	0.45	brass	0.47

cable socket	M8, angular	M8, straight	M12, angular	M12, angular
number of pins	3-pin	3-pin	3-pin	4-pin
article-no.	VK200071	VK200075	VK200021	VK200321
length	2m	2m	2m	2m
article-no.	VK500071	VK500075	VK500021	VK500321
length	5m	5m	5m	5m
article-no.	VKA00071	VKA00075	VKA00021	VKA00321
length	10m	10m	10m	10m

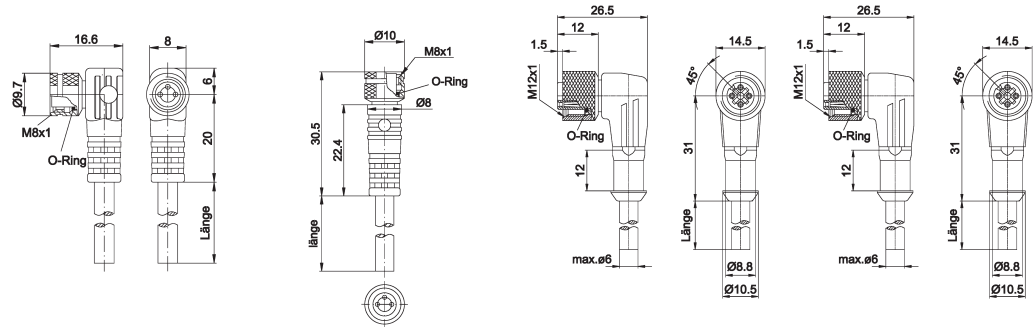

switching output pnp, no

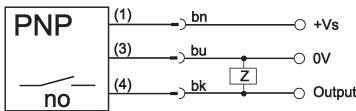

pnp, nc

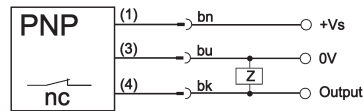

switching output npn, no

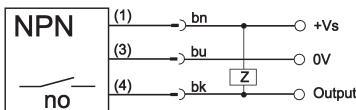

For devices with M12-connector and normally closed contact function (nc), the switching output is wired via PIN2. For this reason a 4-pin cable socket (e.g. VK200325) should be used and the connection made via the white wire.

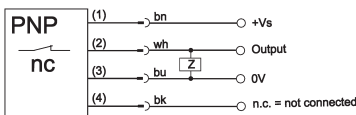

wire colors: bn = brown (1), wh = white (2), bu = blue (3), bk = black (4)

We will be pleased to supply the matching mounting material for your devices. Please refer to the list in catalog chapter "accessories" under "mounting material" or "quick clips"

ACCESSORIES

article-no.	description	material
AY000088	base module *	flanges: stainless steel, ball pins: galvanized steel
AY000115	mounting kit for sensors M5x1	stainless steel
AY000115	mounting kit for sensors M8x1	stainless steel
AY000115	mounting kit for sensors M12x1	stainless steel
AY000117	mounting kit for sensors M18x1	stainless steel

* The **AY000088** base module is contained in every mounting kit.
Material of bolts and nuts: galvanized steel

ACCESSORIES

article-no.	description	sensor-diameter	material article / bolts
AY000044	quick clip	4mm	PA6 / galvanized steel
AY000045	quick clip	5mm	PA6 / galvanized steel
AY000046	quick clip	6.5mm	PA6 / galvanized steel
AY000047	quick clip	8mm	PA6 / galvanized steel
AY000048	quick clip with positive stop	8mm	PA6 / galvanized steel
AY000049	quick clip	12mm	PA6 / galvanized steel
AY000050	quick clip with positive stop	12mm	PA6 / galvanized steel
AY000051	quick clip	18mm	PA6 / galvanized steel
AY000052	quick clip with positive stop	18mm	PA6 / galvanized steel
AY000061	quick clip	30mm	PA6 / galvanized steel
AY000062	quick clip with positive stop	30mm	PA6 / galvanized steel
AY000053	straight base for quick clip	12mm, 18mm	PA6 / galvanized steel
AY000054	angular base for quick clip	12mm, 18mm	PA6 / galvanized steel
AY000055	quick clip label	12 ... 30mm	plastic / -
AY000057	box set with selection of quick clips	4 ... 18mm	plastic / -

This data sheet contains the standard versions only. Kindly request the availability of other output and connection versions.

We will be pleased to supply the matching cable socket for your devices with connector. Please refer to the list in catalog chapter „accessories“ under „cable sockets **ipf-SENSORFLEX**“ or search our website for „VK“.

Warning: Never use these devices in applications where the safety of a person depends on their functionality.

This data sheet as well as your personal contact can be found at www.ipf-electronic.com