

- ▶ **inductive high temperature sensors**
up to +230°C
connection to amplifier

flush, non-flush, amplifier

NOTES

A large grid area for taking notes, consisting of a 20x30 grid of small squares. The grid is empty and occupies the majority of the page below the 'NOTES' header.

dimensions	M8 x 1	
	M18 x 1mm	
	M30 x 1.5mm	
	M50 x 1.5mm	
	40 x 40mm	
flush	switching distance	2 to 20mm
non-flush	switching distance	15 to 25mm



- ✓ an innovation of ipf electronic
- ✓ robust stain. steel housing
- ✓ connection to external amplifier
- ✓ connection with teflon cable, M12- or Lemo-connector



**active surface made of Vectra®
devices usable up to +230°C**

DC
—

PNP
NPN

description

Inductive high temperature sensors are available in the M8, M18, M30, M50 and cubic designs. The connection is made via an external amplifier.

The maximum ambient temperature for the M8 version is +140°C; for the M18, M30, M50 and cuboid versions it is +230°C. The devices are available with silicone or teflon cables and also with M12 or Lemo connectors.

To obtain the maximum switching distance, pay attention to the size of the object (standard target) and its surface finish (even surface).

The external evaluation electronics are available in three different versions. The M12 housing version (**IV120450**) for laying in cable ducts and the version with zinc diecast hous-

ing (**IV400720**) for mounting in the field are connected via M12 plug connectors and have degree of protection IP65. For switching cabinet installation on a top hat rail, model **IV850700**, which has terminal connections, is available.

application examples

- ▶ integration in machine parts subject to rough industrial environments
- ▶ robotics applications in welding plants
- ▶ detection of hot workpieces in the steel industry, in foundries and glass manufacture
- ▶ positioning hot parts in handling and conveying systems
- ▶ foodstuffs industry, chemical industry

Notes on inductive proximity switches

I	inductive sensor
IB	flush
IN	non-flush
IV	amplifier

functional principle

The oscillation coil behind the active surface of the proximity switch produces an alternating electromagnetic field. Any electrically conductive material entering the field will induce rotational currents extracting energy from the oscillating circuit. The damping of the oscillator is then converted into a switching signal in the output amplifier.

It follows the functional principle that all metals are detected, moving or not. Important: The high frequency field produces no measurable increase in temperature and no magnetic influence inside the object to be detected. That means the sensors operate without interacting with the system.

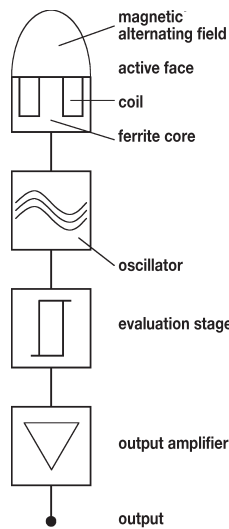

functional principle of an inductive proximity switch

switching distance / norm measuring plate

The distance to the sensor surface, where a metal causes a change in the switching state, is called switching distance. This distance is not the same for all metals. That is why a so-called correction factor has been specified for the respective metal, e.g. copper or aluminum. The nominal switching distance S_n is determined by a norm measuring plate. This is a quadratic metal plate made from steel (St37) with a thickness of 1mm and a smoothed surface for determining the switching distance S_n , otherwise the edge length is the same as the diameter of the active surface.

One differentiates between the normal switching distance S_n , which is determined without consideration for manufacturing tolerances or external influences, and the operational switching distance S_a .

The safe operational switching distance is between 0 and 81% of S_n ($0 < S_a < 0.81 \times S_n$).

switching hysteresis

During the approach and subsequent removal of the measuring plate from the initiator there will be a difference between switch-on point and switch-off point. This integrated hysteresis prevents the switching output from oscillating during mechanical vibrations. Usually the hysteresis is between 5 to 15% of S_n .

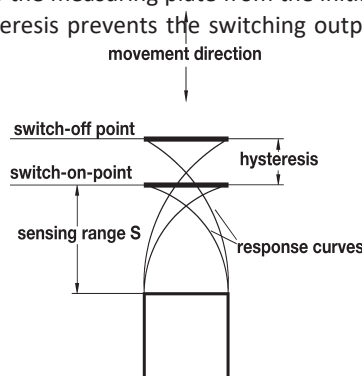

output circuit

For the switching outputs of direct current devices a differentiation is made between PNP and NPN. For PNP outputs the load is connected in such a way that it is energized (positive switching) when the sensor is driven to full output (damping). NPN devices maintain their load permanently energized, switching the earth connection only (negative switching). A corresponding wiring diagram is supplied with every sensor.

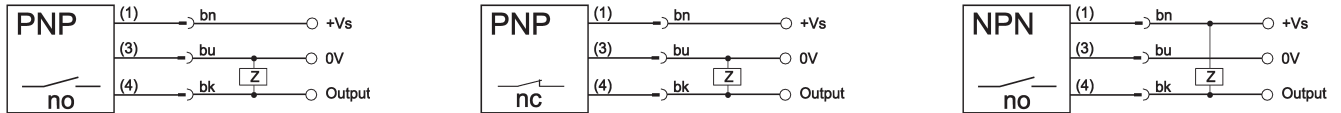

series connection

When a number of sensors are connected in series, the voltage drop of each device should be taken into account in order to ensure that the final device also receives the required operating voltage. The internal electronics permits a maximum of 3 devices to be connected in series.

To be operationally safe the connection in series of 3-wire PNP sensors requires a logical AND-gate, e.g. VL250100.

parallel connection

When connecting 3-wire PNP-sensors in parallel, the internal resistance of the sensor that is driven to full output influences the other proximity switches. This requires decoupling diodes to be inserted into the outputs. A logical OR-gate, e.g. the VL250120, can be used to facilitate the connection in parallel.

mounting

Please follow the mounting instructions for flush or non-flush sensors when installing inductive proximity switches into a metal backing material to avoid undefined switching of the device. For a flush device the active face may be on one level with the backing material.

Non-flush sensors must protrude. As a rule of thumb use 2x the nominal switching distance of the sensor.

mounting instructions for flush sensors

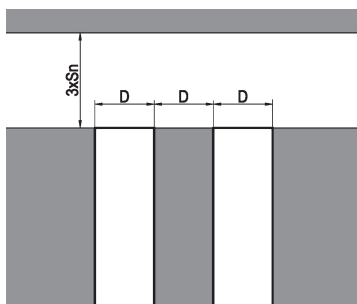

mounting instructions for non-flush sensors

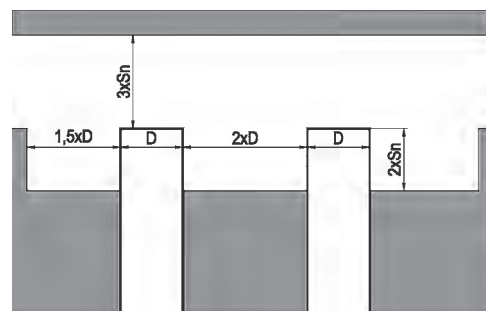

switching frequency

The switching frequency states the maximum number of available switching operations per second. Every switching operation of the inductive proximity switch triggers the oscillating circuit.

The time needed for the oscillation puts a limit on the switching frequency.

For half the nominal switching distance the pulse to pause ratio should be at least 1 : 2,

i.e. when choosing the right proximity switch, a compromise needs to be made between the size of the sensor and the switching frequency. General rule: The larger the sensor, the smaller the switching frequency.

tightening torques

To avoid damage when mounting proximity switches, never exceed the tightening torque given.

stainless steel thread

M8 = 8Nm

M18 = 50Nm

M30 = 150Nm

M50 = 200Nm

active switching zone / active surface:

The active switching zone is the area in front of the active surface, within which the proximity switch reacts to the approach of metal parts, i.e. changes the state of the output.

nominal switching distance (S_n):

The distance at which a metal part that is approaching the active surface of the proximity switch causes a change in the state of the switching output.

real switching distance (S_r):

The actual switching distance may vary due to component tolerances or external influences. For devices of this series, it may vary from the nominal switching distance by up to max. ±20%.

repeatability:

Repeat accuracy of two measurements under standardized conditions. The difference in the measured values should be less than 10%.

output function:

normally open: Object within the area of the active switching zone – output switched

normally closed: Object within the area of the active switching zone – output inhibited

readiness delay:

Time required by the proximity switch to be functional after the supply voltage is applied (lies in the millisecond range).

correction factor:

Specify the reduction in the switching distance, if materials other than steel St37 are used. The change in the switching distance depends on the type, characteristics (internal structure), size and the geometry of the material that is to be detected.

typical correction factors: St37: 1 V2A: approx. 0.7 Ms: approx. 0.4 Al: approx. 0.3 Cu: approx. 0.2

In order to assess the approximate switching distance on the materials which differ from St37, the switching distance for St37 has to be multiplied by the appropriate correction factor.

repeat accuracy

The repeat accuracy (according to IEC 60947-5-2 / EN 60947-5-2) is the repeat accuracy of the real switching distance S_r over a period of 8 hours at an ambient temperature of (23 ± 5)°C and a defined operating voltage. The specified repeat accuracy corresponds to this definition. Generally the repeat accuracy is considerably better in case of sequent measurements.

reverse polarity protection:

An internal protection prevents destruction of the proximity switch if the connection lines are accidentally swapped.

short-circuit protection:

An internal protection prevents destruction of the proximity switch in case of an overcurrent.

switching point drift:

The switching point shifts due to the change in ambient temperature.

Warning: Never use these devices in applications where the safety of a person depends on their functionality.

switching distance	2mm	5mm	5mm
operating temperature	0 ... +140°C	0 ... +230°C	0 ... +230°C
mounting	flush	flush	flush
3m teflon cable/ M12-connector	IB086050	IB186050	IB186053
5m teflon cable/ M12-connector	-	IB186051	-
10m teflon cable/ M12-connector	-	IB186052	-

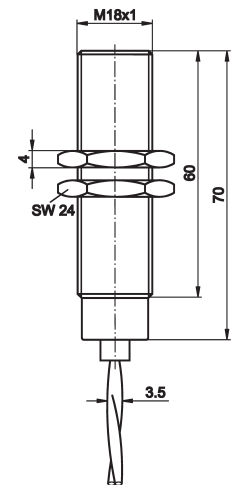
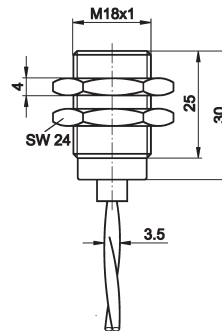
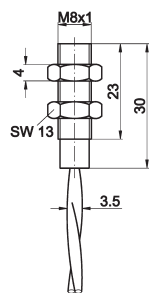

TECHNICAL DATA

switching distance (S _n)	2mm	5mm	5mm
mounting	flush	flush	flush
output signal	see following pages	see following pages	see following pages
operating voltage	see following pages	see following pages	see following pages
hysteresis	2 ... 15%	2 ... 15%	2 ... 15%
switching frequency	300Hz	300Hz	300Hz
reverse polarity protection	+	+	+
dimensions	M8x1	M18x1mm	M18x1mm
length (thread/complete)	23mm / 30mm	25mm / 30mm	60mm / 70mm
housing material	stainl. steel	stainl. steel	stainl. steel
material (front cap)	Vectra®	Vectra®	Vectra®
operating temperature	0 ... +140°C	0 ... +230°C	0 ... +230°C
degree of protection (EN 60529)	IP50	IP50	IP50
connection	3m teflon cable/M12-connector	see above	3m teflon cable/M12-connector
connection accessories	-	-	-
mounting accessories	AY000098	AY000100	AY000100

switching distance	10mm	10mm	15mm	15mm
operating temperature	0 ... +230°C	0 ... +230°C	0 ... +230°C	0 ... +230°C
mounting	flush	flush	non-flush	non-flush
3m teflon cable/ M12-connector	IB306050	-	IN306050	-
5m teflon cable/ M12-connector	IB306051	-	IN306051	-
10m teflon cable/ M12-connector	IB306052	-	IN306052	-
15m teflon cable/ M12-connector	-	-	IN306053	-
Lemo connector	-	IB306040	-	IN306040

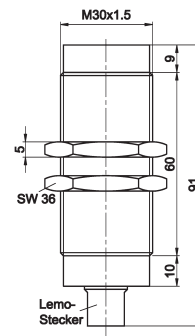
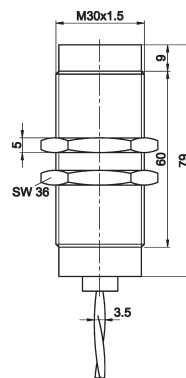
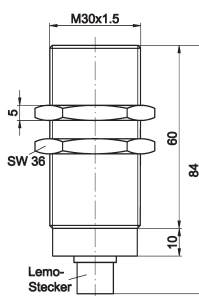
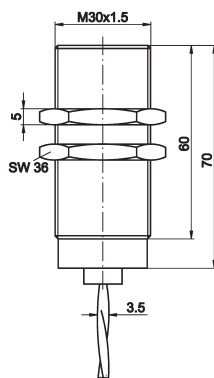

TECHNICAL DATA

switching distance (S _n)	10mm	10mm	15mm	15mm
mounting	flush	flush	non-flush	non-flush
output signal	see following pages	see following pages	see following pages	see following pages
operating voltage	see following pages	see following pages	see following pages	see following pages
hysteresis	2 ... 15%	2 ... 15%	2 ... 15%	2 ... 15%
switching frequency	200Hz	200Hz	150Hz	150Hz
reverse polarity protection	+	+	+	+
dimensions	M30x1.5mm	M30x1.5mm	M30x1.5mm	M30x1.5mm
length (thread/complete)	60mm / 70mm	60mm / 84mm	60mm / 79mm	60mm / 91mm
housing material	stainl. steel	stainl. steel	stainl. steel	stainl. steel
material (front cap)	Vectra®	Vectra®	Vectra®	Vectra®
operating temperature	0 ... +230°C	0 ... +230°C	0 ... +230°C	0 ... +230°C
degree of protection (EN 60529)	IP50	IP50	IP50	IP50
connection	see above	Lemo-connector	see above	Lemo-connector
connection accessories	-	e.g. VK206941	-	e.g. VK206941
mounting accessories	AY000101	AY000101	AY000101	AY000101

switching distance	20mm	20mm	25mm
operating temperature	0 ... +230°C	0 ... +230°C	0 ... +230°C
mounting	flush	flush	non-flush
3m teflon cable/ M12-connector	IB506050	-	-
5m teflon cable/ M12-connector	IB506051	-	-
10m teflon cable/ M12-connector	IB506052	-	-
Lemo connector	-	IB506040	IN50C543

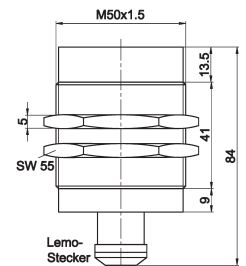
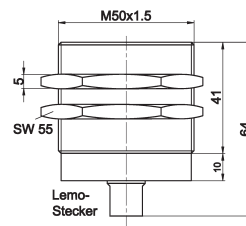
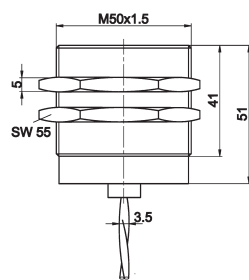

TECHNICAL DATA

switching distance (S _n)	20mm	20mm	25mm
mounting	flush	flush	non-flush
output signal	see following pages	see following pages	see following pages
operating voltage	see following pages	see following pages	see following pages
hysteresis	2 ... 15%	2 ... 15%	2 ... 15%
switching frequency	150Hz	150Hz	150Hz
reverse polarity protection	+	+	+
dimensions	M50x1.5mm	M50x1.5mm	M50x1.5mm
length (thread/complete)	41mm / 51mm	41mm / 64mm	41mm / 64mm
housing material	stainl. steel	stainl. steel	stainl. steel
material (front cap)	Vectra®	Vectra®	Vectra®
operating temperature	0 ... +230°C	0 ... +230°C	0 ... +230°C
degree of protection (EN 60529)	IP50	IP50	IP68
connection	see above	Lemo-connector	Lemo-connector
connection accessories	-	e.g. VK206941	e.g. VKB0C590
mounting accessories	AY000102	AY000102	AY000102

switching distance	25mm	25mm	20mm
operating temperature	0 ... +230°C	0 ... +230°C	0 ... +230°C
mounting	non-flush	non-flush	non-flush
3m teflon cable/ M12-connector	IN506050	-	-
5m teflon cable/ M12-connector	IN506051	-	-
10m teflon cable/ M12-connector	IN506052	-	-
Lemo connector	-	IN506040	IN406040

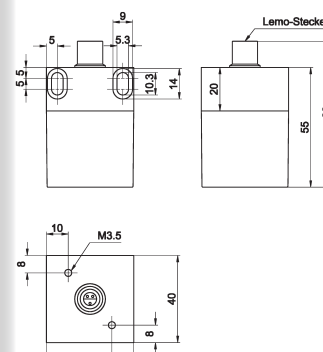
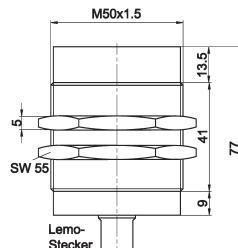
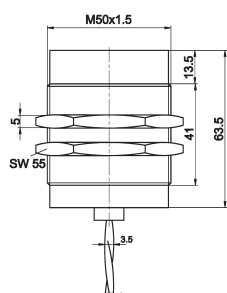

TECHNICAL DATA

switching distance (S _n)	25mm	25mm	20mm
mounting	non-flush	non-flush	non-flush
output signal	see following pages	see following pages	see following pages
operating voltage	see following pages	see following pages	see following pages
hysteresis	2 ... 15%	2 ... 15%	2 ... 15%
switching frequency	150Hz	150Hz	100Hz
reverse polarity protection	+	+	+
dimensions	M50x1.5mm	M50x1.5mm	40x40x66mm
length (thread/complete)	41mm / 63.5mm	41mm / 77mm	-
housing material	stainl. steel	stainl. steel	stainl. steel
material (front cap)	Vectra®	Vectra®	Vectra®
operating temperature	0 ... +230°C	0 ... +230°C	0 ... +230°C
degree of protection (EN 60529)	IP50	IP50	IP50
connection	see above	see above	Lemo-connector
connection accessories	-	e.g. VK206941	e.g. VK206F41
mounting accessories	AY000102	AY000102	AY000135

article-no.	IV120450
connection	sensor: M12 cable socket 300mm supply / connection: 2m PUR-cable
version	integrated line monitoring *

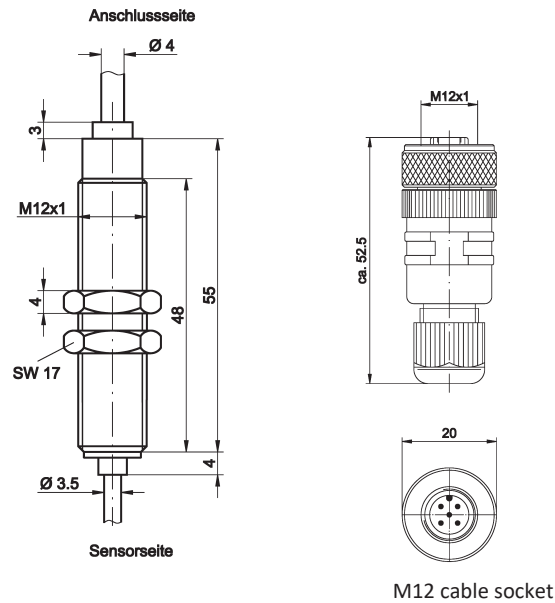

TECHNICAL DATA

output signal	pnp / no, pnp / nc
operating voltage	7 ... 35V DC
current consumption (w/o load)	≤ 25mA
output current (max. load)	300mA
voltage drop (max. load)	2.0V DC
switching frequency	1kHz
short-circuit protection	+
reverse polarity protection	+
dimensions	M12x1mm
housing material	stainl. steel
length (thread/complete)	48mm / 55mm
operating temperature	-25 ... +75°C
degree of protection (EN 60529)	IP65
connection	see above
mounting accessories	AY000099

* in event of short circuit or interruption in the line between sensor and amplifier, both outputs switch to "high".

article-no.	IV400720	IV850700
connection	sensor: M12 cable socket supply / output: M12-connector	sensor: terminals supply / output: terminals
version	integrated line monitoring *	integrated line monitoring *
TECHNICAL DATA		
output signal	pnp, no/nc, alarm	pnp, no/nc, alarm
operating voltage	10 ... 30V DC	10 ... 30V DC
current consumption (w/o load)	≤ 25mA	≤ 25mA
output current (max. load)	200mA	200mA
voltage drop (max. load)	2.0V DC	2.0V DC
switching frequency	1kHz	1kHz
display (signal)	+	+
short-circuit protection	+	+
reverse polarity protection	+	+
dimensions	40x42x88mm	17.8x85x65mm
housing material	aluminum	plastic
length (thread/complete)	- / -	- / -
operating temperature	-25 ... +75°C	-25 ... +75°C
degree of protection (EN 60529)	IP65	IP20
connection	see above	see above
* in event of short circuit or interruption in the line between sensor and amplifier, both outputs switch to "high".		

adjustment options IV400720 / IV850700

DIP switch	On	Off
1	output 2 = exclusive-OR	output 2 = alarm
2	setting control on	setting control off
3	time delay on	time delay off
4	turn-on delay 0-1s (potentiometer)	turn-off delay 0-1s (potentiometer)
5	high hysteresis / high setting control	small hysteresis / small setting control
6	3-wire sensors	2-wire sensors

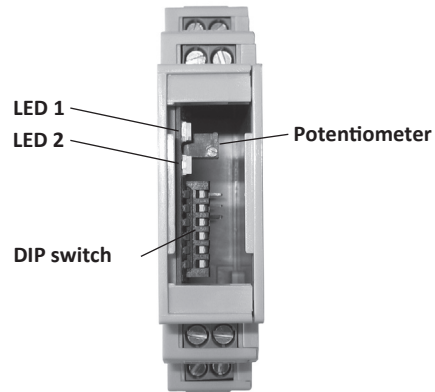
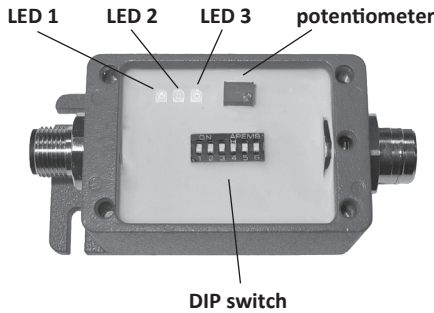

green LED 1: operating voltage
 yellow LED 2: object identified
 red LED 3: lights up: sensor is not connected
 flashes: functional reserve range
 lights up + yellow LED flashes: short circuit at the output

Green/yellow LED 1: operating voltage / object identified
 Red LED 2: lights up: sensor is not connected
 flashes: functional reserve range
 lights up + yellow LED flashes: short circuit at the output

setting control:

If the setting control is activated (DIP switch 2 'on'), the red LED flashes in order to identify the standby functional reserve. An object that is to be recorded must be located sufficiently close to the sensor so that the yellow LED lights up and the red LED does not flash. Objects that don't have to be recorded must be sufficiently far away from the sensor so that both LEDs do not light up. If the red LED flashes while the sensor is running, then it has to be re-adjusted.

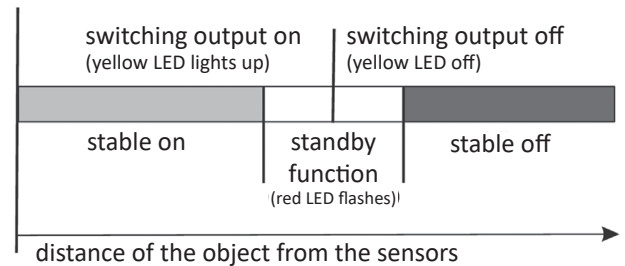

alarm output:

The alarm output is activated by switching DIP switch 1 to the 'on' setting. If no sensor is connected, or if the line to the sensor is disconnected, the alarm output will switch on. In addition, the red LED will light up. The alarm output also switches on if there is a short circuit on the switching output of the amplifier. In this case, the red LED lights up and the yellow LED flashes.

hysteresis setting:

The hysteresis can be set in two stages in order to adjust the size of the connected sensors. For large sensors (designs 30 and 50), it is recommended that the "small" setting be selected; for small sensors (design 18), the "large" setting should be used. The sensors depicted in this catalog that are designed for operation with an external amplifier are two-wire sensors. The electrical connection between the sensor and amplifier takes place via two wires: brown (PIN 1 of M12-connector) and blue (PIN 3 of M12-connector).

pin configuration IV400720

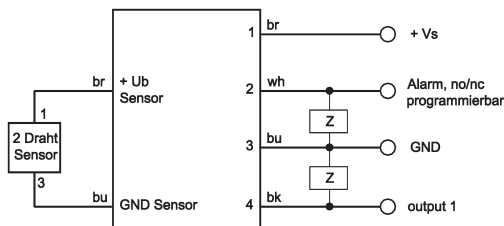

IV850700

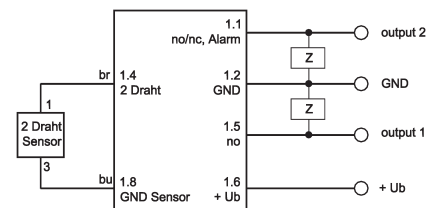

Only one sensor can be connected!

connection	sensor: lemo, straight, shielded -	sensor: lemo, straight, shielded amplifier: M12-connector
outer jacket material	teflon	teflon
version	connection to amplifier IV850700	connection to amplifier IV120450 / IV400720
article-no.	VK206941	VK206F41
length	2m	2m
article-no.	VK506941	VK506F41
length	5m	5m
article-no.	VKA06941	VKA06F41
length	10m	10m

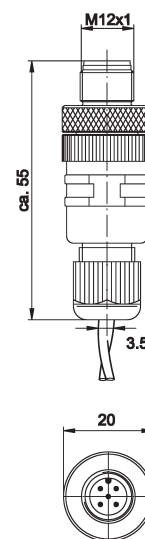
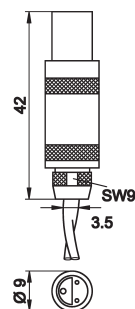
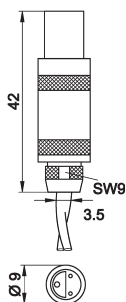

connection	-	sensor: lemo, straight, shielded amplifier: M12-connector
outer jacket material	-	teflon
version	-	connection to amplifier IV120450 / IV400720
article-no.	-	VKB0C590
length	-	20m

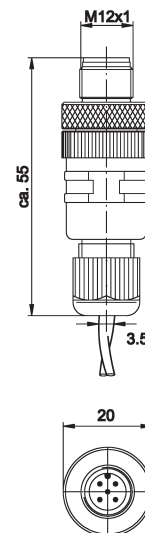
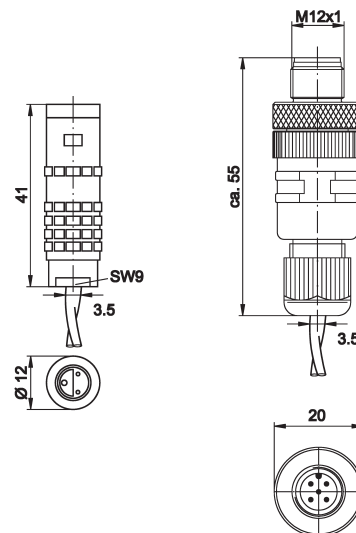

connection

connector device 2-wire (sensors)

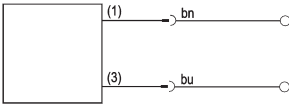

wire colors: bn = brown (1), bu = blue (3), bk = black (4)

amplifier IV400720

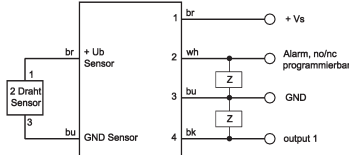

wire colors: bn = brown (1), wh = white (2), bu = blue (3), bk = black (4)

amplifier IV120450

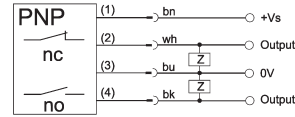

amplifier IV850700

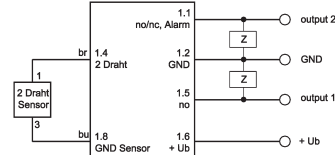

mounting accessories

AY000098 for design M8x1, stainl. steel

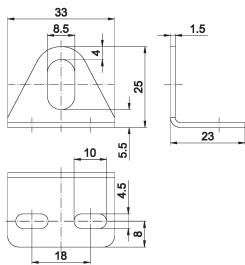

AY000099 for design M12x1, stainl. steel

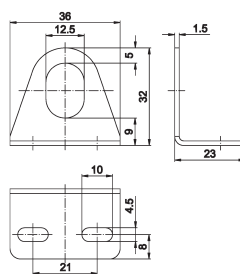

AY000100 for design M18x1, stainl. steel

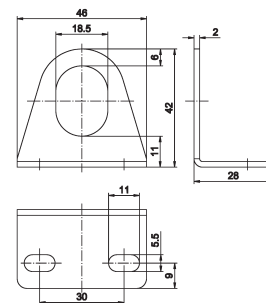

AY000101 for design M30x1.5, stainl. steel

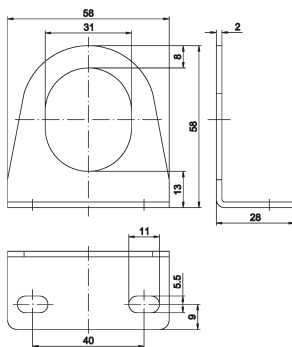

AY000102 for design M50x1.5, aluminum

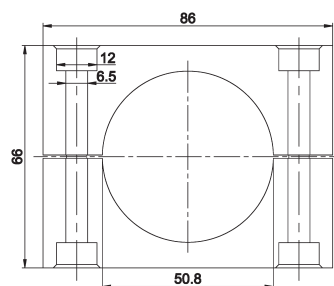

AY000104 for design M30x1.5, aluminum

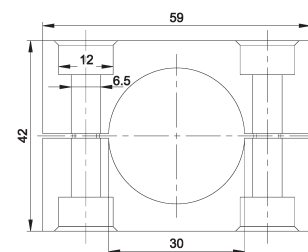

AY000135 for design 40x40, stainl. steel

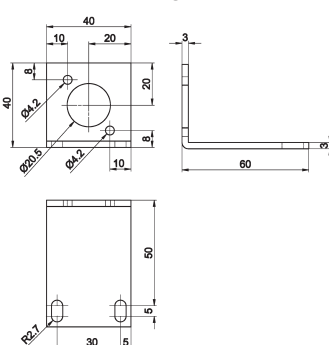

This data sheet contains only the available standard versions. Please contact us for other output and connection versions.

We will be pleased to supply the matching cable socket for your connector devices. Please refer to the list in catalog chapter "accessories" under "cable sockets **ipf-SENSORFLEX®**" or search our website for "VK".

Warning: Never use these devices in applications where the safety of a person depends on their functionality.

NOTES

A large grid area for taking notes, consisting of a 30x30 grid of small squares. The grid is empty and occupies the majority of the page below the 'NOTES' header.