

dimensions **Ø38 x 118mm**
temperature operating range **-40 to +300°C**

- ✓ **temperature measuring range from -40 to +300°C**
- ✓ **M12 connection socket for PT100 resistance thermometer**
- ✓ **analog output with adjustable start and end point**
- ✓ **separately adjustable turn-on and turn-off delay**
- ✓ **test function – simulation of set switching functions without resistance thermometer connected**
- ✓ **peak hold function for display**
- ✓ **self-monitoring function: overload, wire breakage and sensor function**

**intelligent temperature sensor
membrane keyboard, USB opto interface**



11

description

The **YT35** temperature sensor from **ipf electronic** offers a high level of operating comfort. The device has 2 outputs. Whereas output 1 is a freely programmable switching output, output 2 can be configured as an analog, switching or alarm output. Devices with a 8-pin connection have 2 switching outputs and an analog output. The membrane keyboard can be used to program, among other things, the switching points, release positions, output logic as well as time delays. The sensor has an M12 connection for a PT100 resistance thermometer and can be used up to a measurement temperature of 300°C. The PT100 and the appropriate screw-in sleeves can be found on this data sheet. The screw-in sleeves enable fast replacement because the resistance thermometer is separated from the process by means of the mounting connection. The PT100 measures tem-

perature at the first two centimeters of its test probe. All adjustment parameters can be set and changed via a PC or notebook via the optical interface of the sensor. For dynamic measurements, the display and the analog output feature an adjustable damping function. Following installation, the sensor body can be rotated by 350° and the sensor display can be rotated by 180° by means of the software. The test function offers a simple and quick possibility to check the function of the device and/or the connected analyses. To allow this, each temperature value of the temperature measuring range can be „simulated“ using the operating buttons or the PC software. The device then behaves as if a temperature sensor were connected.

application examples

- ▶ fluid and air temperature monitoring in furnaces and machines

article-no.	YT353100
temperature (medium)	-40 ... +300°C
output	0/4 ... 20mA, 20 ... 0/4mA / 2 x pnp, no/nc
connection	M12-connector, 4-pin

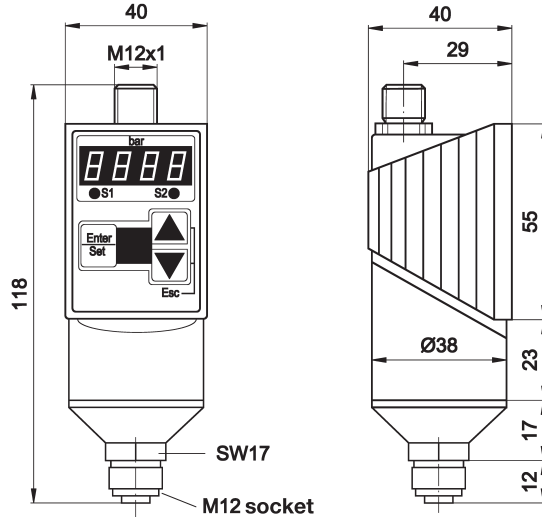

TECHNICAL DATA

temperature (medium)	-40 ... +300°C
measuring method	resistance thermometer PT100 (2, 3, or 4-wire)
output	0/4 ... 20mA, 20 ... 0/4mA / 2 x pnp no / nc
operating voltage	12 ... 32V DC
output current (max. load)	1A
current consumption (w/o load)	< 60mA
voltage drop (max. load)	< 2.0V DC
turn-on/off delay	0 ... 20s
adjustment range	1 ... 100% of final value switching point 0 ... 99% of final value release position
switching frequency	max. 125Hz
repeat accuracy	< ±0.1% of the final value
analog output	
burden	max. $RL \Omega = (U_b - 8V) / 20mA$
error recognition	in case of line break, overload, measurement error
rise time	5ms (10 ... 90% of the final value)
damping adjustable	0 ... 20s
linearity deviation	max. ±0.25% of T_n
display (LED)	4 x 7-segment LED
damping (display)	adjustable, 0 ... 20s
display (signal)	2 x red LED
short-circuit protection	+
reverse polarity protection	+
housing material	PA6.6, polyester
dimensions	Ø 38x118mm
operating temperature	-20 ... +80°C
temperature drift	< ±0.2% / 10K, (-10 ... +70°C)
degree of protection (EN 60529)	IP65
connection	M12-connector, 4-pin
connection accessories	e.g. VK205325
connection (sensing element)	M12 cable socket, 4-pin, with rotating coupler
interface	opto-adapter on USB + software AD000011
mounting accessories (clip)	AY000060

article-no.	YT353120
temperature (medium)	-40 ... +300°C
output	0/4 ... 20mA, 20 ... 0/4mA / 2 x pnp, no/nc
connection	M12-connector, 8-pin

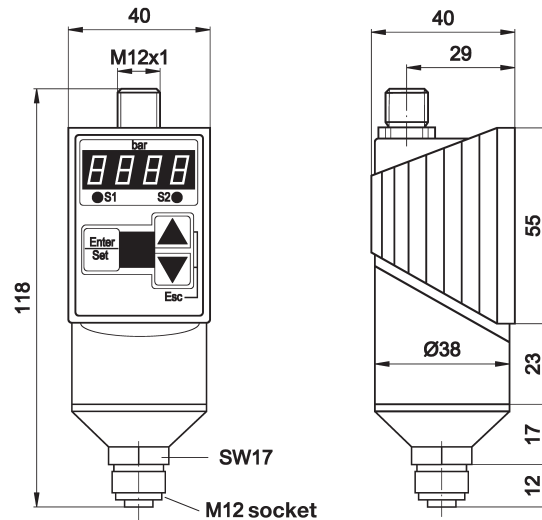

TECHNICAL DATA

temperature (medium)	-40 ... +300°C
measuring method	resistance thermometer PT100 (2, 3, or 4-wire)
output	0/4 ... 20mA, 20 ... 0/4mA / 2 x pnp no / nc
operating voltage	12 ... 32V DC
output current (max. load)	1A
current consumption (w/o load)	< 60mA
voltage drop (max. load)	< 2.0V DC
turn-on/off delay	0 ... 20s
adjustment range	1 ... 100% of final value switching point 0 ... 99% of final value release position
switching frequency	max. 125Hz
repeat accuracy	< ±0.1% of the final value
analog output	
burden	max. $RL \Omega = (U_b - 8V) / 20mA$
error recognition	in case of line break, overload, measurement error
rise time	5ms (10 ... 90% of the final value)
damping adjustable	0 ... 20s
linearity deviation	max. ±0.25% of T_n
display (LED)	4 x 7-segment LED
damping (display)	adjustable, 0 ... 20s
display (signal)	2 x red LED
short-circuit protection	+
reverse polarity protection	+
housing material	PA6.6, polyester
dimensions	∅ 38x118mm
operating temperature	-20 ... +80°C
temperature drift	< ±0.2% / 10K, (-10 ... +70°C)
degree of protection (EN 60529)	IP65
connection	M12-connector, 8-pin
connection accessories	e.g. VK205A25
connection (sensing element)	M12 cable socket, 4-pin, with rotating coupler
interface	opto-adapter on USB + software AD000011
mounting accessories (clip)	AY000060



resistance thermometer
PT100

article-no.	YT036020	YT036021	YT036022	YT036023	YT036024	YT036025
length	100mm	150mm	250mm	350mm	500mm	1000mm

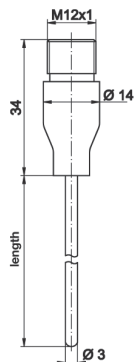

TECHNICAL DATA

temperature (medium)	-30 ... +350°C
operating voltage	connection to YT353100 or YT353120
resistance value	100Ω at 0°C as per IEC 751 class A
measuring accuracy	±0.06Ω at 0°C ±0.15°C
hysteresis	depends on medium
insulation resistance	100Ω at 100Vcc
design	densely packed magnesium oxide insulation
bending radius	min. 9mm
outer diameter	Ø 3mm
outer jacket material	stainless steel 1.4401

screw-in sleeve

article-no.	AT000001	AT000005	AT000007	AT000002	AT000003	AT000008
process connection	G¼"	G¼"	G¼"	G½"	G½"	G½"
length	100mm	900mm	300mm	100mm	40mm	450mm

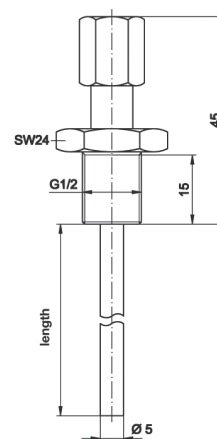
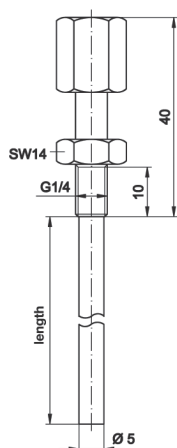

TECHNICAL DATA

temperature (medium)	-40 ... +300°C
mounting connection	see above - according to DIN ISO 228
outer diameter	Ø 5mm
material	stainless steel 1.4401
material (ring socket)	attachment (PT100) with stainless steel V-ring
pressure (max.)	100bar at +350°C

connection

4-pin

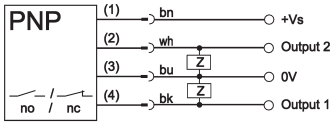

output 2, selectable between switching, analog and alarm output

wire colors bn = brown (1), wh = white (2), bu = blue (3), bk = black (4)

8-pin

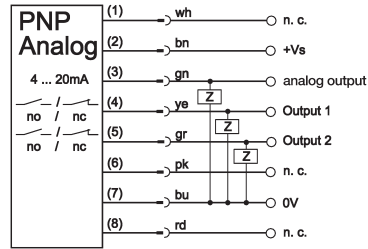

wire colors wh = white (1), bn = brown (2), gn = green (3), ye = yellow (4), gy = gray (5), pk = pink (6), bu = blue (7), rd = red (8)
n. c. = not connected



programmable switching functions (examples)

switch-point with release position

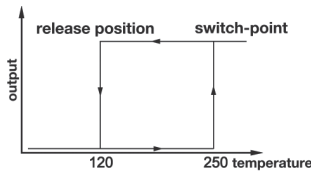

switch-point with hysteresis

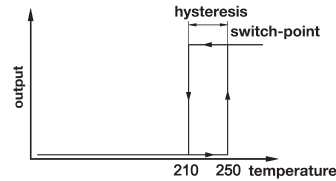

window function with release position

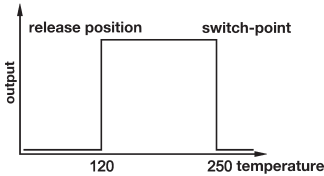

window function with hysteresis

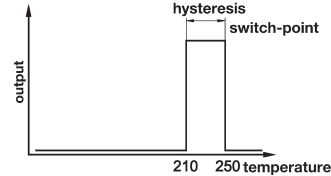

mounting clip AY000060

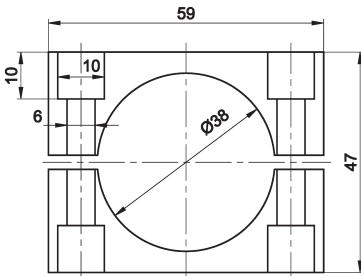

ACCESSORIES

article-no.	description	note
AD000011	optical interface	USB connection, software, 1.5m cable
AY000060	mounting clip	plastic
AT000004	adapter for pipe attachment of YT35	hose clamp required



comfortable software

At first glance, all functions can be seen straight away and are quickly changeable.

graphical user interface

The user interface of the software has an extremely clear graphical layout; this makes operation easy.

test function

The test function offers a simple and quick possibility to check the function of the device and/or the connected analyses. To allow this, each temperature can be simulated using the operating buttons or the PC software.

opto USB interface

Even during operation, you can communicate with the pressure sensor via the opto USB interface (galvanically separated).

self-critical

The auto-monitoring function of the temperature sensor indicates the following: Overshooting or undershooting of the measuring range, short circuit at output 1 / output 2, defective temperature sensor, internal fault, and analog output open. The onward transmission of the faults to the control can take place via the alarm or analog output.

tamper proof

The keypad lock can be engaged via the membrane keyboard or as a hard lock. The hardlock can only be operated via the software.

data logging function

The software offers the opportunity to write measured values in an Excel table. Data logging can be triggered either time or measurement controlled.



This data sheet only contains the available standard variants. For other output / connection variants, we kindly ask that you contact us.

We are happy to supply the right cable socket for the plug equipment. You will find a list in the “accessories” section of the catalog under **ipf-SENSORFLEX**® “cable sockets” or in the search window on our homepage www.ipf-electronic.com (using the search term “VK”).

Warning: Never use these devices in applications where the safety of a person depends on their functionality.

You also find this data sheet, as well as contact details under www.ipf-electronic.com