

general

Ultrasonic sensors are contactless and wear-free position switches that can also be used under harsh environmental conditions. A key advantage of these devices is that they can detect objects made of nearly any material and with nearly any surface texture. Solid, liquid, granular and powdery materials are detected without the shape or color of the objects having any effect on the measurement result. The ability to detect transparent materials such as foils or liquids is of special significance.

With a piezoelectric sound transducer, short pulses or pulse trains are emitted at specific time intervals. After being reflected at the measurement object, the signals are again received by the sensor and the propagation time measured. Using this time, which is proportional to the signal path, the speed of sound C is used to calculate the distance to the object:

$$S_n = (C \times t) / 2$$
 The propagation velocity of sound in air is heavily dependent on temperature and is 343m/s at a temperature of 20°C. The value changes by approx. 0.18% per degree °C. Temperature fluctuations in the air are therefore offset by means of a temperature-compensated propagation time measurement.

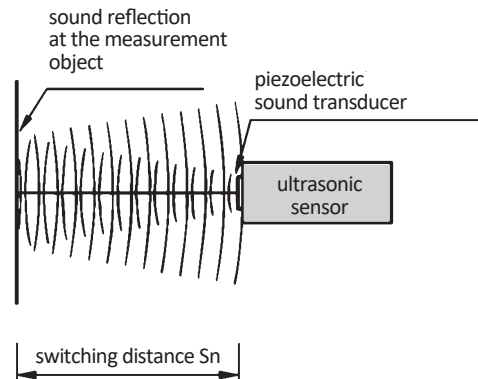

Depending on the application in positioning, regulation and control systems, the requirements on these sensors vary widely. Often, the versions are therefore offered with one analog output (current or voltage) and one switching output (pnp or npn). Moreover, with some sensors it is possible to transfer the measurement result via an RS232 interface. Programming of the sensor can then also be programmed via this interface.

Many ultrasonic sensors with digital output include a switching point that is adjustable via a potentiometer or by means of teach-in. The object is thereby detected only at an exactly defined distance.

synchronization (e.g. UT180126 / UT180127 / UT180128)

With sensors that are operated very close to one another, mutual interference may occur. To avoid this effect, the sensors are synchronized, i.e., the transmission pulse is emitted at the same time for all sensors. The synchronization occurs automatically if the corresponding connections lines of the sensors are connected to one another. The sensor with the longest echo propagation time determines the measurement frequency. Furthermore, the receiving sensitivity can be adjusted via a potentiometer in order to compensate for the influence of echos from other sensors, two-source echos or echos from the sides.

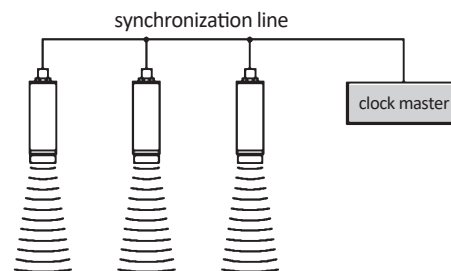

dead zone

The dead zone is defined as the area between the sensor head and the minimum switching distance. The sensor may not be used within this area since objects are not detected or are detected in an undefined manner.

dimensions	M12x1		
dif. reflection sensors (norm.)	measuring range	10 ...	200mm
dif. reflection sensors (beam column.)	measuring range	2 ...	82mm
dif. reflection sensors (norm.)	detection range	30 ...	200mm
dif. reflection sensors (beam column.)	detection range	5 ...	70mm

- ✓ very small angle of beam spread
- ✓ version with attached beam columnator for nearly linear sound cone
- ✓ LED switching state display and setting control
- ✓ setting via teach-in input
- ✓ integrated amplifier

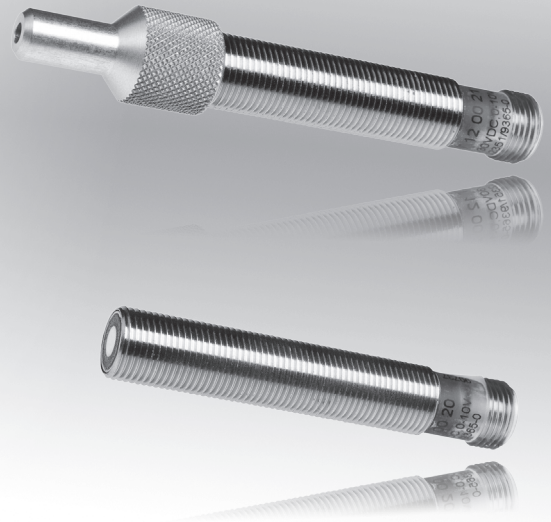

analog output 0 to 10V or switching output with teach-in



description

The ultrasonic sensors from *ipf electronic* make possible contactless and non-contacting position detection. The distances are determined using the echo propagation time process. Here, the propagation time measurement is temperature compensated and makes possible very accurate detection of sound-reflecting objects of any color and material over a large temperature range. Due to the high sound frequency, the ultrasonic sensor is insensitive to interference even in harsh industrial environments. To teach-in the analog output or the switching point, the supply voltage is applied to the teach-in input. Serving as an alignment and setting control is an LED display that supports the adjustment in teach-in mode. Analog sensors: any interval within the measuring range (measuring range section $\geq 5\text{mm}$) can be taught in for the analog output.

Switching sensors: the sensing range within the detection range can be taught in very exactly for the PNP output. Version with beam columnator: by calibrating the sensors to this attachment element, which was manufactured specifically for this purpose, the lateral spread of the sound cone is reduced and straightened (quasi linear).

application examples

- ▶ filling level measurement of a wide range of materials
- ▶ measurement of heights, e.g., packages on conveyor belts or pallets
- ▶ distance measurement of optically undetectable materials
- ▶ winding and unwinding control of any type of foil
- ▶ control of material tension by means of sag measurement
- ▶ detection of thicknesses and diameters
- ▶ length and distance measurement systems



article-no.	UT120020	UT120021
version	dif. reflection sensor	dif. reflection sensor with beam columnator
measuring range	20 ... 200mm	2 ... 82mm
output signal	0 ... 10V DC	0 ... 10V DC

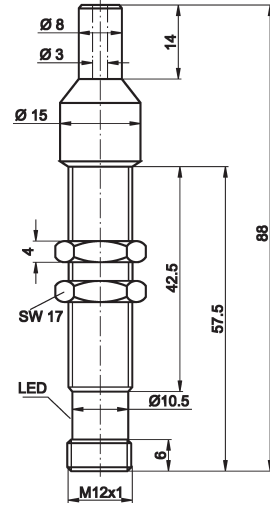
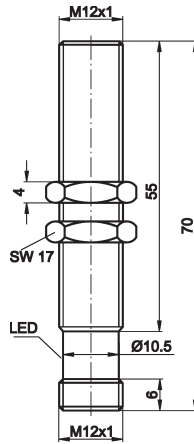

TECHNICAL DATA

measuring range	20 ... 200mm	2 ... 82mm
output signal	0 ... 10V DC	0 ... 10V DC
operating voltage	15 ... 30V DC	15 ... 30V DC
current consumption (w/o load)	≤ 35mA	≤ 35mA
output current (w/o load)	≤ 20mA	≤ 20mA
resolution	≤ 0.3mm	≤ 0.3mm
temperature drift	≤ 2% S teach	≤ 2% S teach
repeat accuracy	≤ 0.5mm	≤ 0.5mm
carrier frequency	380kHz	380kHz
response/decay time	≤ 30ms / ≤ 30ms	≤ 30ms / ≤ 30ms
sound frequency	16Hz	16Hz
display (teach)	yellow + red LED	yellow + red LED
display (measuring range)	yellow LED	yellow LED
display (alarm)	red LED below measuring range	red LED below measuring range
setting	remote-teach input (supply on pin 2)	remote-teach input (supply on pin 2)
short-circuit protection	+	+
reverse polarity protection	+	+
dimensions	M12x1	M12x1
length (thread/complete)	55mm / 70mm	42.5mm / 88mm
housing material	nickel-plated brass	nickel-plated brass
operating temperature	-10 ... +60°C	-10 ... +60°C
degree of protection (EN 60529)	IP67	IP67
connection	M12-connector, 4-pin	M12-connector, 4-pin
connection accessories	e.g. VK200325	e.g. VK200325
mounting accessories (universal holder)	AY000115	AY000115
accessories	teach adapter: AV000114	teach adapter: AV000114

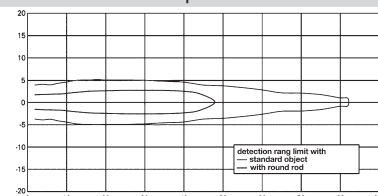
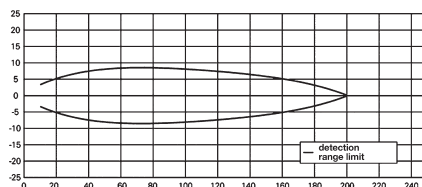

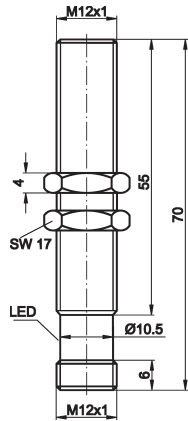
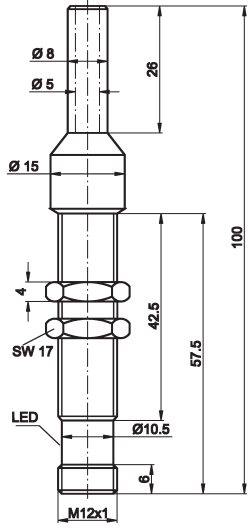
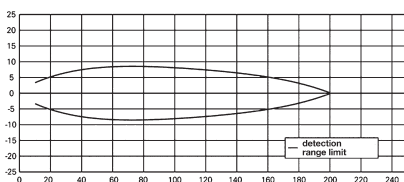
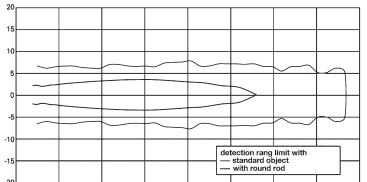
article-no.	UT120120	UT120121
version	dif. reflection sensor	dif. reflection sensor with beam columnator
sensing range	10 ... 200mm	5 ... 70mm
output	pnp, no	pnp, no
article-no.	UT120220	-
output	pnp, nc	-
article-no.	UT121120	-
output	npn, no	-
		
TECHNICAL DATA		
sensing range	10 ... 200mm	5 ... 70mm
output signal	see above	see above
operating voltage	12 ... 30V DC	12 ... 30V DC
current consumption (w/o load)	≤ 35mA	≤ 35mA
output current (max. load)	≤ 200mA	≤ 200mA
voltage drop (max. load)	2V DC	2V DC
temperature drift	≤ 0.18% S teach	≤ 0.18% S teach
hysteresis	4%	4%
repeat accuracy	≤ 0.5mm	≤ 0.5mm
carrier frequency	380kHz	380kHz
response/decay time	≤ 10ms / ≤ 10ms	≤ 10ms / ≤ 10ms
switching frequency	50Hz	50Hz
display (teach)	green flashing LED	green flashing LED
display (signal)	green LED	green LED
setting	remote-teach input (supply on pin 2)	remote-teach input (supply on pin 2)
short-circuit protection	+	+
reverse polarity protection	+	+
dimensions	M12x1	M12x1
length (thread/complete)	55mm / 70mm	42.5mm / 100mm
housing material	nickel-plated brass	nickel-plated brass
operating temperature	-10 ... +60°C	-10 ... +60°C
degree of protection (EN 60529)	IP67	IP67
connection	M12-connector, 4-pin	M12-connector, 4-pin
connection accessories	e.g. VK200325	e.g. VK200325
mounting accessories (universal holder)	AY000115	AY000115
accessories	teach adapter: AV000114	teach adapter: AV000114
		

connection

analog

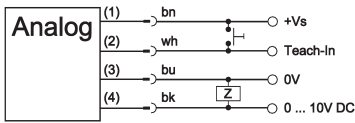

wire colors: bn = brown (1), wh = white (2), bu = blue (3), bk = black (4)

digital

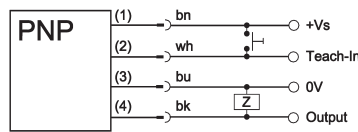

universal mounting AY000115 consisting of base module ...

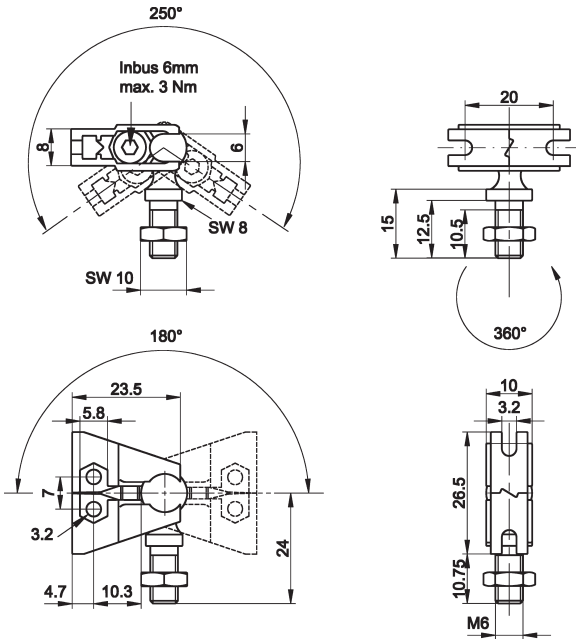

... and fitting panel

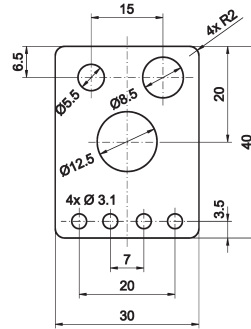

AY000049

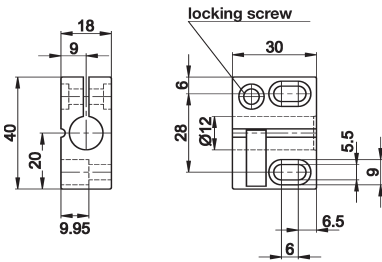

AY000053

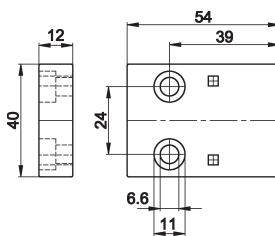

AY000054

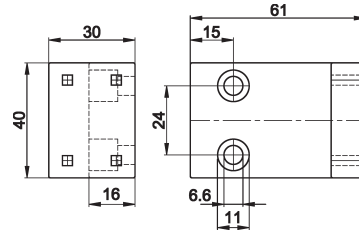

ACCESSORIES

article-no.	description	note
AY000088	base module *	jaws: stainless steel, ball pin: galvanized steel
AY000115	mounting kit for M5, M8, M12 sensors	stainless steel
AY000049	quick clip 12, plastic	for M12-sensor, round
AY000053	base, straight, plastic	for quick clip 12 and 18, round
AY000054	base, angular, plastic	for quick clip 12 and 18, round
AY000114	teach-in, adapter	M12-socket/M12-connector

* The AY000088 base module is included with each mounting kit. Material of the screw and nuts: galvanized steel

This data sheet only contains the available standard variants. For other output / connection variants, we kindly ask that you contact us.

We are happy to supply the right cable socket for the plug equipment. You will find a list in the "accessories" section of the catalog under **ipf-SENSORFLEX**® "cable sockets" or in the search window on our homepage www.ipf-electronic.com (using the search term "VK").

Warning: Never use these devices in applications where the safety of a person depends on their functionality.

You also find this data sheet, as well as contact details under www.ipf-electronic.com